

# MANUAL FOR EROSION AND SEDIMENT CONTROL IN GEORGIA

2016 Edition



**Georgia Soil and Water Conservation Commission**

**P.O. Box 8024  
4310 Lexington Rd  
Athens, GA 30603  
706-552-4470  
706-552-4486 fax  
<https://gaswcc.georgia.gov/>**

**DRAFT FOR PUBLIC COMMENT**

Please note that some of the images are blurry and are currently being updated. Please direct comments to the text of the document.

The preparation of this Manual was financed in part through a grant from the U.S. Environmental Protection Agency to the Environmental Protection Division of the Georgia Department of Natural Resources under Provisions of Section 319(h) of the Federal Water Pollution Control Act, as amended.

All programs and services of the federal, state and local agencies listed above are available on a nondiscriminatory basis without regard to race, color, national origin, religion, sex, age, marital status, handicap or disability. If you need this document in an alternative format, call 706-552-4470.

## PREFACE TO THE 2016 EDITION

The 2016 Edition of the “Manual for Erosion and Sediment Control in Georgia” has been revised with a focus on erosion control. Implementation of newly researched practices has been incorporated to expand on the traditional erosion and sediment control practices which are included in the 2016 Edition. These new practices have been proven to aid in controlling erosion and subsequent sedimentation in a cost-effective manner.

It is important that this publication is used as a guideline and that “creativity” must be utilized when necessary to fully protect a site from erosion and subsequent sedimentation. What is required on erosion and sediment control plans has been modified and includes the current plan review checklists with guidance documents.

The 2016 Edition includes new BMPs and a process for Alternative BMPs to be included on the Equivalent BMP list. This application and removal process is found in Appendix A-2. The Manual has also been revised to include an updated Erosion and Sedimentation Control Plan.

It is hoped that users of this Manual will realize the significant changes and recognize that technology changes rapidly in the erosion and sediment control arena. The Commission is dedicated to providing the State of Georgia with the latest “proven” erosion and sediment control practices.

The Commission is appreciative of all of the help and guidance received during the revision of the Manual. Many thanks go to the Georgia Department of Transportation, Natural Resources Conservation Service, DNR Environmental Protection Division, DNR Wildlife and Fisheries.

A special thanks to the Technical Advisory Committee: Joshua Escue, Dr. Britt Faucette, Adena Ful-lard, Reece Parker, Jim Sloan and Brian Watson. To the advisors to the Technical Advisory Committee: Davie Biagi - GA DOT, Diane A. Guthrie - NRCS, Marc Mastronardi - GA DOT, and Dewey Richardson- GA EPD. To the Technical Advisory Planning Committee: Michael W. Breedlove, Jim Hamilton, Georgene Geary, Anna Bramblett, J. Brian Kimsey, Dr. Mark Risse, Wayne King, John Slupecki, Jimmy Dean and Jan Sammons. To the Overview Council: Terry England, Chair of Overview Council, State Representative for the 116th House District; Robert Brant Lane, Hodges, Harbin, Newberry and Tribble, Inc.; Bert M. Brantley, State Road and Tollway Authority; John B. Harrison, Jr., Baldwin Paving Co., Inc.; Ronny Just, Georgia Power; Marc Mastronardi, GA DOT; Tom McCall, State Representative for the 33rd House District; and Mary Walker, GA EPD.

Technical Editors: Benton Ruzowicz, J. Guerry Thomas, Lauren Zdunczyk, and Brady Hart.



## FOREWORD

Perhaps the most harmful damage to Georgia's land and water resources is incurred through unchecked and uncorrected erosion and sediment deposition. Years of work have done much to remedy the situation. There has also been created an awareness that efforts must continue to further reduce the volume of the sediment pollution in all the state's waters.

While ongoing work in soil and water conservation has been of considerable success, it was recognized that some state regulation of land-disturbing activities could add a needed dimension to the overall control effort. The General Assembly responded to this need, and in 1975, the Erosion and Sedimentation Act (O.C.G.A. § 12-7-1 et seq.) was passed. The Act has been amended several times since then.

The Act requires counties and municipalities to have erosion and sediment control ordinances or be covered under state regulations. While the Soil and Water Conservation Districts provide assistance in this at the local level, the State Soil and Water Conservation Commission provides expert, step-by-step guidance for activities under such ordinances through a comprehensive publication of reference information. Thus the "Manual for Erosion and Sediment Control in Georgia" can serve as a technical guide in formulating plans for land-disturbing activities. In preparing the manual, the State Conservation Commission is indebted to the many hundreds of researchers, engineers, farmers, conservationists and others who, over the years, made possible the accumulation of information on modern conservation.

The criteria, standards and specifications contained in Chapter 6 must be incorporated into all local erosion and sediment control programs. The remaining chapters and sections of this Manual contain guidelines and support materials to assist users in the implementation of best management practices in accordance with the provisions of the Erosion and Sedimentation Act.



# TABLE OF CONTENTS

	Page
PREFACE .....	v
FOREWORD .....	vii
CHAPTER 1 The Erosion and Sedimentation Act of 1975 .....	1-1
CHAPTER 2 Sediment and Erosion Control Processes, Principles and Practices .....	2-1
CHAPTER 3 Planning and Plans .....	3-1
CHAPTER 4 Local Programs: Principles and Processes .....	4-1
CHAPTER 5 Sources of Assistance and Resource Information .....	5-1
CHAPTER 6 BMP Standards and Specifications for General Land-Disturbing Activities .....	6-1
APPENDIX A-1 Estimating Runoff from Urban Areas .....	A-1
APPENDIX A-2 Joining the Equivalent BMP List: Application and Removal Process .....	A-2
APPENDIX B-1 Soil Series Interpretations .....	B-1-1
APPENDIX B-2 Soil Loss Predictions .....	B-2-1
APPENDIX C Construction Materials .....	C-1
APPENDIX D Model Soil Erosion and Sedimentation Control Ordinance .....	D-1
APPENDIX E Conversion Factors .....	E-1
APPENDIX F Glossary .....	F-1
REFERENCES .....	G-1





# CHAPTER 1

## THE EROSION AND SEDIMENTATION ACT OF 1975

On April 24, 1975, the Honorable George Busbee, Governor of the State of Georgia, signed into law as Act 599, the Erosion and Sedimentation (E&S) Act of 1975 (O.C.G.A. § 12-7-1 et. seq.) This landmark legislation was the result of over five years of exhausting work, debate and legislative compromise.

With the passage of the Act, Georgia joined the few far-sighted states adopting legislation specifically designed to protect soil and water resources. Georgia's E&S Act shows great concern for local implementation and local enforcement. There exists in Georgia a mechanism whereby local decision makers can do something about the abuses of soil and water resources.

O.C.G.A. § 12-7-2 states: "It is found that soil erosion and sediment deposition onto lands and into waters within the watersheds of this state are occurring as a result of widespread failure to apply proper soil erosion and sedimentation control practices in land clearing, soil movement and construction activities, and that such erosion and sediment deposition result in pollution of state waters and damage to domestic, agricultural, recreational, fish and wildlife, and other resource uses. It is, therefore, declared to be the policy of this state and the intent of this chapter to strengthen and extend the present erosion and sediment control activities and programs of this state and to provide for the establishment and implementation of a state-wide comprehensive soil erosion and sediment control program to conserve and protect land, water, air and other resources of this state."

Sediment in Georgia comes from many sources including agricultural operations, forestry practices, construction projects and other activities that convert land from one use to another.

Historically, farm land has been the greatest source of sediment. The trend was reversed around the midpoint of the century with much idle land or land in row crops planted to perennial grasses or trees. In 2007, the Annual Natural Resources



**Figure 1.1 - Advanced gully erosion on an abandoned construction site.**

Inventory, conducted by the Natural Resources Conservation Service (NRCS), showed a continuing trend in reduced soil erosion of croplands. Between 1982 and 2007, soil erosion from wind and water on U.S. cropland (on non-Federal land) decreased 43%. In 1982, the total was 3.06 billion tons and in 2007, the total was 1.73 billion tons.

Urban development is now a major source of sedimentation and pollutants into waters of the State. The increased impervious cover due to developments also increases runoff and stream flows which cause stream bank erosion, and increases the elevation of the floodplain.

Erosion damage is costly to repair, often requiring regrading or replacement of eroded soil and replacement of damaged pavements and structures. Sediment damages are not only unnecessary, but extremely costly.

Georgia's Soil and Water Conservation Districts (SWCD) have been charged with performing a vital role in the implementation of Act 599. Since their formation beginning in 1937, the districts have worked toward treating each acre of land in accordance with its capabilities. The Districts, and the District Supervisors for each county in Georgia can be found on the Georgia Soil and Water Conservation Commission (GSWCC) website at <https://gaswcc.georgia.gov/>.

The Manual for Erosion and Sediment Control in Georgia deals primarily with land-disturbing activities in urban and urbanizing areas. It should be remembered that the same methodology and expertise is required in planning for the conservation of soil and water on any lands. The Manual for Best Management Practices for Georgia Agriculture is

available on the GSWCC website, and the Manual for Forestry BMPs is available from the Georgia Forestry Commission.

### PROVISIONS UNDER ACT 599

Act 599 requires that governing authorities of Georgia's 159 counties and more than 550 incorporated municipalities adopt comprehensive ordinances governing land-disturbing activities within their boundaries. The ordinances must contain technical principles as provided in the law and procedures for issuance of permits. All Erosion, Sedimentation & Pollution Control Ordinances must be reviewed and approved by the Environmental Protection Division (GA EPD) of the Georgia Department of Natural Resources (DNR). A model ES&PC Ordinance can be found on both the GSWCC and GA EPD websites, <https://gaswcc.georgia.gov/> and <http://epd.georgia.gov/>.

Local ordinances must meet or exceed the standards, requirements, and provisions of the E&S Act and the state general permit (NPDES). The ordinance may not exceed the NPDES permit requirements for monitoring, reporting, inspections, design standards, turbidity standards, education and training, and project size thresholds with regard to education and training requirements.

The law could have a significant impact on any area's natural resource base because it requires detailed planning before land-disturbing activities are undertaken. The law requires that erosion and sediment control plans for each non-exempt activity be prepared and submitted with application to the Local Issuing Authority (LIA) for a permit. The



**Figure 1.3 - If unchecked, sediment would gradually fill up this lake.**

plans will then be forwarded to the appropriate Soil and Water Conservation District. The District shall have 35 days to approve or deny the plan with the reason for denial. With each resubmittal of the plan, the 35 days for review starts again. The plan review would bypass District approval if the LIA demonstrates that it possesses the capability and expertise to conduct erosion and sediment control plan reviews and enters into an agreement with the District.

After a thorough analysis of the plans, they will be returned to the issuing authority with the District's recommendations upon which the issuing authority will issue or deny permits. Should a permit be denied because of a discrepancy in the plans, such discrepancies must be made apparent to the applicant. The law requires that a permit be issued or denied within a period not to exceed 45 days after the plan and applications are submitted. If a permit is denied there are appeal procedures provided for in the Act.

Municipalities and counties failing to have adopted an E&S Ordinance will be subject to rules and regulations developed by the GA EPD.

GA EPD does not issue Land Disturbance Permits. The terms of the NPDES permit will apply and be enforced by GA EPD. Coverage under the state general permit will begin fourteen days after submitting a Notice of Intent (NOI), and the required fees to the appropriate GA EPD office. It is recommended that the applicant reads and understands the appropriate NPDES permit.

In 2003, the E&S Act was amended requiring all persons involved in land development design, review, permitting, construction, monitoring, or in-



**Figure 1.2 - Maintaining outlet protection due to BMP failures higher in the drainage basin.**

spection or any land-disturbing activity to meet the education and training certification requirements developed by the GSWCC.

To meet the requirements of O.C.G.A. § 12-7-19, GSWCC has developed the following four levels of certification:

- 1 Level I Awareness Seminar, a two hour class which is for sub-contractors.
- 2 Level IA Fundamentals Seminar, an eight hour class for persons installing and/or inspecting BMPs.
- 3 Level IB Advanced Fundamentals Seminar, an eight hour class for regulatory inspectors and non-regulatory personnel contracted to conduct regulatory work.
- 4 Level II Introduction to Design Seminar, a sixteen hour class for persons designing and/or reviewing ES&PC plans.

#### LAND-DISTURBING ACTIVITY:

Any activity which may result in soil erosion from water or wind and the movement of sediments into state waters or onto lands within the state, including, but not limited to:

1. clearing
2. dredging
3. grading
4. excavating
5. transporting
6. filling

## EXEMPTIONS FROM THE ACT

### O.G.C.A. § 12-7-17

#### LAND DISTURBING ACTIVITY DOES NOT INCLUDE:

1. **Surface mining**, as the same as defined in Code Section 12-4-72
2. **Granite quarrying** and land clearing for such quarrying.
3. **Minor land-disturbing activities**, such as home gardens and individual home landscaping, repairs, maintenance work, fences, and other related activities which result in minor soil erosion\*
4. **The construction of single-family residences**, when such construction disturbs less than one acre and is not a part of a larger common plan of development or sale with a planned disturbance of equal to or greater than one acre and not otherwise exempted under this paragraph; provided, however, that construction of any such residence shall conform to the minimum requirements as set forth in subsection (b) of Code Section 12-7-6 and this paragraph.

For single-family residence construction covered by the provisions of this paragraph, there shall be a buffer zone between the residence and any state waters classified as trout streams pursuant to Article 2 of Chapter 5 of this title. In any such buffer zone, no land-disturbing activity shall be constructed between the residence and the point where vegetation has been wrested by normal stream flow or wave action from the banks of the trout waters.

For primary trout waters, the buffer zone shall be at least 50 horizontal feet, and no variance to a smaller buffer shall be granted. For secondary trout waters, the buffer zone shall be at least 50 horizontal feet, but the director may grant variances to no less than 25 feet. Regardless of whether a trout stream is primary or secondary, for first order trout waters, which are streams

into which no other streams flow except for springs, the buffer shall be at least 25 horizontal feet, and no variance to a smaller buffer shall be granted. The minimum requirements of subsection (b) of Code Section 12-7-6 and the buffer zones provided by this paragraph shall be enforced by the issuing authority

5. **Agricultural operations** as defined in Code Section 1-3-3 to include those practices involving the establishment, cultivation, or harvesting of products of the field or orchard; the preparation and planting of pasture land; farm ponds; dairy operations; livestock and poultry management practices; and the construction of farm buildings
6. **Forestry land management practices**, including harvesting; provided, however, that when such exempt forestry practices cause or result in land-disturbing or other activities otherwise prohibited in a buffer, as established in paragraphs (15) and (16) of subsection (b) of Code Section 12-7-6, no other land-disturbing activities, except for normal forest management practices, shall be allowed on the entire property upon which the forestry practices were conducted for a period of three years after the completion of such forestry practices
7. **Any project carried out under the technical supervision of the Natural Resources Conservation Service of the United States Department of Agriculture**
8. **Any project involving less than one acre of disturbed area**; provided, however, that this exemption shall not apply to any land-disturbing activity within a larger common plan of development or sale with a planned disturbance of equal to or greater than one acre or within 200 feet of the bank of any state waters, and for purposes of this paragraph, "state waters" excludes channels and drainage-ways which have water in them only during and immediately after rainfall events and intermittent streams which do not have water in them year round; provided, however, that any person responsible

for a project which involves less than one acre, which involves land-disturbing activity, and which is within 200 feet of any such excluded channel or drainage-way must prevent sediment from moving beyond the boundaries of the property on which such project is located and provided, further, that nothing contained in this chapter shall prevent a city or county which is a Local Issuing Authority from regulating any such project which is not specifically exempted by paragraph (1), (2), (3), (4), (5), (6), (7), (9), or (10) of this Code section;

**9. Construction or maintenance projects, or both, undertaken or financed in whole or in part, or both, by the Department of Transportation, the Georgia Highway Authority, or the State Road and Tollway Authority;** or any road construction or maintenance project, or both, undertaken by any county or municipality; provided, however, that construction or maintenance projects of the Department of Transportation or the State Road and Tollway Authority which disturb one or more contiguous acres of land shall be subject to the provisions of Code Section 12-7-7.1; except where the Department of Transportation, the Georgia Highway Authority, or the State Road and Tollway Authority is a secondary permittee for a project located within a larger common plan of development or sale under the state general permit, in which case a copy of a Notice of Intent under the state general permit shall be submitted to the Local Issuing Authority, the Local Issuing Authority shall enforce compliance with the minimum requirements set forth in Code Section 12-7-6 as if a permit had been issued, and violations shall be subject to the same penalties as violations by permit holders\*\*.

**10. Any land-disturbing activities conducted by any electric membership corporation or municipal electrical system or any public utility under the regulatory jurisdiction of the Public Service Commission,** any utility under the regulatory ju-

isdiction of the Federal Energy Regulatory Commission, any cable television system as defined in Code Section 36-18-1, or any agency or instrumentality of the United States engaged in the generation, transmission, or distribution of power; except where an electric membership corporation or municipal electrical system or any public utility under the regulatory jurisdiction of the Public Service Commission, any utility under the regulatory jurisdiction of the Federal Energy Regulatory Commission, any cable television system as defined in Code Section 36-18-1, or any agency or instrumentality of the United States engaged in the generation, transmission, or distribution of power is a secondary permittee for a project located within a larger common plan of development or sale under the state general permit, in which case the Local Issuing Authority shall enforce compliance with the minimum requirements set forth in Code Section 12-7-6 as if a permit had been issued, and violations shall be subject to the same penalties as violations by permit holders\*\*.

**11. Public water system reservoirs.**

\*Minor land-disturbing guidance document can be found at the GA EPD website <http://epd.georgia.gov/>.

\*\*Coverage under the NPDES permit is not required for discharges of storm water associated with infrastructure construction projects that consist solely of routine maintenance for the original purpose of the facility that is performed to maintain the original line and grade and the hydraulic capacity, as applicable. For eligibility requirements for this exemption please refer to GAR 100002 Part I.C.1.c.

GSWCC considers maintenance to be the work of keeping something in proper condition; or upkeep.

Abandoned sites may exist within the jurisdiction of an LIA where land disturbance has previously taken place on permitted construction projects. Due to various reasons, work on the projects may

have permanently stopped without the site having undergone final stabilization. The LIA or the owner of such property should contact GA EPD for the latest regulatory guidance to help ensure the sites are stabilized in compliance with the Act and the NPDES Permits. The LIA or owner of such property should contact GSWCC for technical guidance on implementing the correct BMPs. Common BMP's on such sites include, but are not limited to, sediment barriers (perimeter control), sediment storage, temporary and permanent vegetation.

## **THE MANUAL**

This Manual has been assembled to provide guidance in the implementation of Act 599. It was written for four specific audiences.

1. The land disturbers: landowners, developers and their consultants, architects, engineers, land surveyors, planners, etc.
2. The enforcers: officials and employees of local units of government charged with responsibility of administering and enforcing the law on a local level and the Georgia Environmental Protection Division when it is the issuing authority.
3. The plan reviewers: the Georgia Soil and Water Conservation Districts and Local Issuing Authorities.
4. The design professionals.

# CHAPTER 2

## SEDIMENT AND EROSION CONTROL PROCESSES, PRINCIPLES AND PRACTICES

Erosion is the process by which the land surface is worn away by the action of wind, water, ice or gravity.

Natural, or geologic, erosion has been occurring at a relatively slow rate since the earth was formed and is a tremendous factor in creating the earth as we know it today. The picturesque mountains of the north, the fertile farmlands of the Piedmont and the productive estuaries of the coastal zone are all products of geologic erosion and sedimentation in Georgia. Excepting some cases of shore and stream channel erosion, natural erosion occurs at a very slow and uniform rate and remains a vital factor in maintaining environmental balance.

Human alteration of the earth's surface can lead to "accelerated erosion." This is a classic example of environmental abuse and is normally the result of poor planning and unorganized construction.

Erosion by water is a process of breaking loose and transporting soil particles. The energy of raindrops falling on denuded or exposed soils is the key element. The annual impact energy of raindrops, for instance, has been estimated to average approximately 30 billion foot-pounds or the equivalent of 10 thousand tons of dynamite per square mile. Water flowing over exposed soil picks up detached soil particles. As the velocity of flowing water increases, additional soil particles are detached and transported. Water flows have a tendency to concentrate. This first creates small channels or rills and eventually gullies of varying widths and depths. As the volume and velocity of runoff increases in unprotected streams and channels, additional erosion occurs on stream banks and bottoms.

Sedimentation is the process where soil particles settle out of suspension as the velocity of water decreases. The heavier particles, gravel and sand, settle out more rapidly than fine silt and clay par-

ticles. The characteristic reddish color of Georgia's streams in the Piedmont results from suspended microscopic clay particles. Unfortunately, these particles are easily transported and settle out *very slowly*. It is difficult and perhaps impossible to totally eliminate the transportation of these fine particles, even with the most effective erosion control programs.



**Figure 2.1 - Energy of falling raindrops has detached and transported soil particles from unprotected areas.**

### FACTORS INFLUENCING EROSION

The erosion process is influenced primarily by climate, topography, soils, and vegetative cover.

**Climate.** The frequency, intensity and duration of rainfall and temperature extremes are principle factors influencing the volume of runoff from a given area. As the volume and intensity of rainfall increases, the ability of water to detach and transport soil particles increases. When storms are frequent, intense, and of long duration, the potential for erosion of bare soils is high. Temperature has a major influence on soil erosion. Frozen soils are relatively erosion resistant. However, soils with high moisture content are subject to "spew," or uplift by freezing action, and are usually very easily eroded upon thawing.

**Topography.** The size, shape and slope characteristics of a watershed influence the amount and duration of runoff. The greater the slope length and gradient, the greater the potential for both runoff and erosion. Velocities of water will increase as the distance from the top of the slope or the grade of the slope increases.

**Soils.** The soil type will determine its vulnerability to erosion. Properties determining the erodibility of a soil are texture, structure, organic matter content and permeability. Soil containing high percentages of fine sands and silt are normally the most erodible. As the clay and organic matter content of these soils increases, the erodibility decreases. Clays act as a binder to soil particles thus reducing erodibility. But, while clays have a tendency to resist erosion, they are easily transported by water once eroded. Soils high in organic matter resist rain drop impact and the organic matter also increases the binding characteristics of the soil. Clearly, well-graded and well-drained gravels are usually the least erodible soils. The high infiltration rates and permeabilities either prevent or delay runoff.

tremely important factor in reducing erosion from a site. It will:

- a. Absorb energy of rain drops.
- b. Bind soil particles.
- c. Slow velocity of runoff water.
- d. Increase the ability of a soil to absorb water.
- e. Remove subsurface water between rainfalls through the process of evapotranspiration.

By limiting the amount of vegetation disturbed and the exposure of soils to erosive elements, soil erosion can be greatly reduced.

**GENERAL DESIGN PRINCIPLES**

For an erosion and sedimentation control

**Vegetative Cover.** Vegetative cover is an ex-

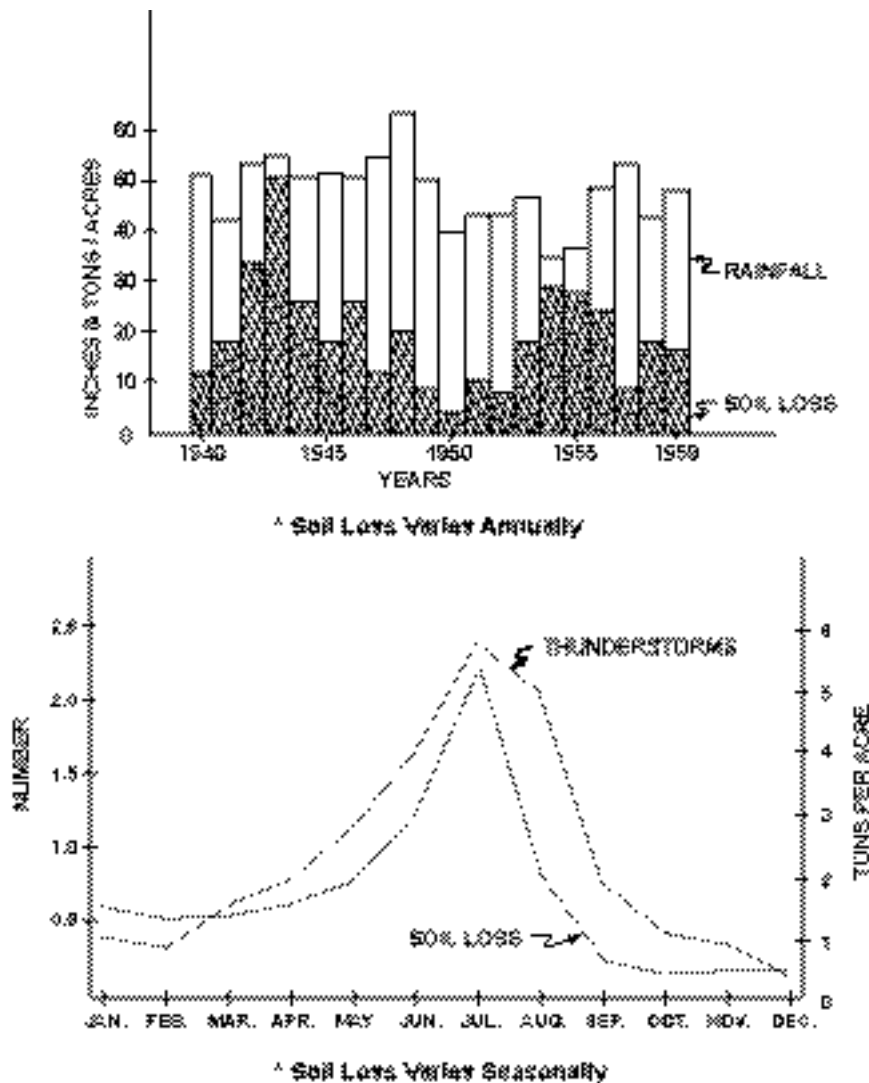

Information taken from: Barnett, A.P. and E.M. Hendrickson, "Erosion on Piedmont Soils," Soil Conservation Magazine, USDA, Soil Conservation Service, Volume XXVI, No. 2 Sept. 1970

Figure 2.2



program to be effective, it is imperative that provisions for sediment control measures be made in the planning stage. These planned measures, when conscientiously and expeditiously applied during construction, will result in orderly development without adverse environmental degradation.

From the previous discussion on erosion and sediment control processes and factors affecting erosion, basic technical principles can be formulated to assist the project planner or designer in providing for effective sediment control. It is felt that these certain key principles *must* be utilized to the maximum extent possible on all projects.

**Fit the Activity to the Topography and Soils.**

Detailed planning should be employed to assure that roadways, buildings and other permanent features of the activity conform to the natural characteristics of the site. Large graded areas should be located on the most level portion of the site. Areas subject to flooding should be avoided. Areas of steep slopes, erodible soils with severe limitations for the intended uses should not be utilized without overcoming the

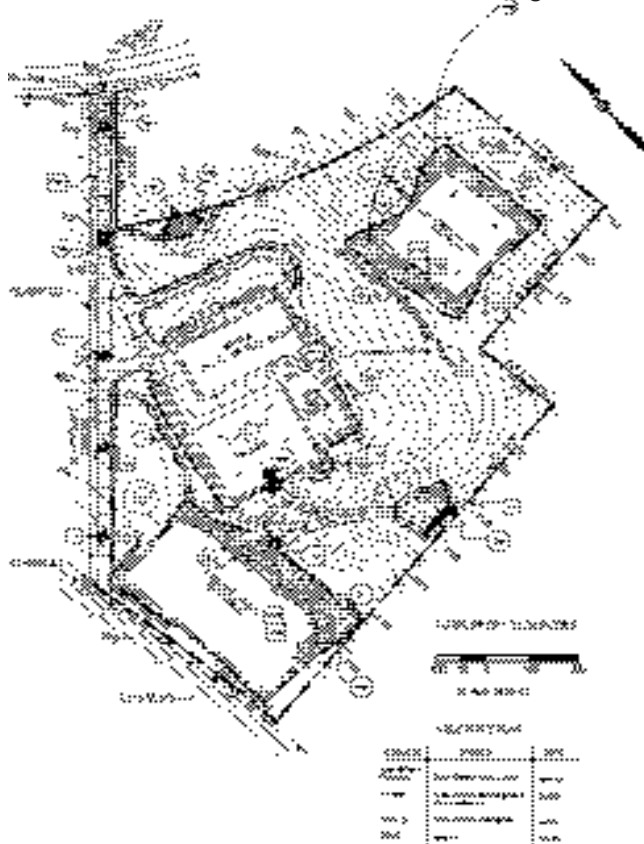

**Figure 2.3 - Permanent facilities for this development were planned to fit the topography and soil type.**



**Figure 2.4 - Unstable soil conditions, as on this roadbank, should be avoided.**

limitations through sound engineering practices. Erosion control, development and maintenance costs can be minimized if a site is selected for a specific activity rather than attempting to modify the site to conform to the proposed activity.

**The Disturbed Area and the Duration of Exposure to Erosion Elements Should be Minimized.** Clearing of natural vegetation should be limited to only those areas of the site to be developed at a given time. Natural vegeta-

**ACTIVITY SCHEDULE**

Activity	Month 1	Month 2	Month 3	Month 4
Initial Perimeter and Sediment Storage BMPs	█			
Clearing & Grubbing	█	█	█	
Erosion Control Devices	█	█	█	
Grading	█	█	█	
Temporary Vegetation	█	█	█	
Infrastructure Construction (Incl. Utilities)		█	█	
Base		█	█	
Paving			█	
Fine Grading			█	

**Figure 2.5**



**Figure 2.6 - Vegetation on this road bank will reduce erosion to a minimum.**

tion should be retained, protected and *supplemented* with construction scheduling employed to limit the duration of soil exposure. Major land clearing and grading operations should be scheduled during seasons of low potential runoff.

**Stabilize Disturbed Areas Immediately.**

Permanent structures, temporary or permanent vegetation, and mulch, or a combination of these measures, should be employed as quickly as possible after the land is disturbed. Temporary vegetation and mulches can be most effective on areas where it is not practical to establish



**Figure 2.7 - Hydroseeding equipment can efficiently and quickly establish disturbed areas.**



**Figure 2.8 - Matting can assist in rapid establishment of vegetation.**

permanent vegetation. These temporary measures should be employed immediately after rough grading is completed, if a delay is anticipated in obtaining finished grade. The finished slope of a cut or fill should be stable and ease of maintenance considered in the design. Stabilize all roadways, parking areas, and paved areas with a gravel subbase, temporary vegetation or mulch.

**Retain or Accommodate Runoff.** Runoff from



**Figure 2.9- This vegetated waterway will safely convey storm water away.**



**Figure 2.10 - Storm water detention structures will reduce storm water runoff from developed areas.**

the development should be safely conveyed to a stable outlet using storm drains, diversions, stable waterways or similar measures. Consideration should also be given to the installation of storm water detention structures to prevent flooding and damage to downstream facilities resulting from increased runoff from the site. The LIA should be consulted for their requirements. Temporary or permanent facilities for conveyance of storm water



**Figure 2.11 - This temporary sediment basin effectively trapped sediment from upstream erosion.**



**Figure 2-12. - A temporary sediment basin converted to a permanent pond enhances landscape.**



**Figure 2.13 - Offsite impact from a neighboring construction site.**



**Figure 2.14 - Temporary bridges or culverts should be employed when construction equipment is required to cross natural or constructed channels**

should be designed to withstand the velocities of projected peak discharges. These facilities should be operational as soon as possible after the start of construction.

**Retain Sediment.** Sediment basins, sediment

barriers and related structures should be installed to filter or trap sediment *on the site to be disturbed*. The most effective method of controlling sediment, however is to control erosion at its *source*. Sediment retention structures should be planned to retain sediment when erosion control methods are not practical, are insufficient, in the process of being installed, or have failed due to some unforeseen factor.

**Do Not Encroach Upon Watercourses.** Permanent buildings should not be subjected to flooding, sediment damages or erosion hazards. Earth fills should not be constructed in flood-prone areas so as to adversely obstruct water flows or increase downstream velocity of water flows. When necessary to span a flood-prone area or watercourse, bridge and culvert openings should be sized to permit passage of peak discharges without causing undue restrictions in water flows or without creating excessive downstream velocities. Uses of flood-prone areas should be limited to activities which would not suffer excessive damages from flooding, scour and sediment. Temporary bridges or culverts should be employed when construction equipment is required to cross natural or constructed channels.

## **EROSION AND SEDIMENTATION CONTROL PRACTICES**

Severe erosion on lands undergoing land-disturbing activities can be reduced if proper control measures are implemented. The timely application of Best Management Practices (BMPs) will minimize the time that the soils are exposed, control runoff, shield the soil from erosive forces, and bind the soils.

A most effective tool in controlling erosion is good site planning which includes planning and installation of BMPs. In Chapter 6, of this Manual are standards and specifications for such practices which can be utilized on areas undergoing land-disturbing activities. These standards were developed to establish statewide uniformity in selection, design, review, approval, installation and maintenance of conservation practices. They establish minimum requirements for planning, designing and installing the practices on disturbed areas.

For effective erosion control, a combination of BMPs must be employed. Alternative BMPs may be approved for individual erosion and sediment control plans. An Alternative BMP Guidance Docu-

ment can be found on the GSWCC website. In general, they fall into the rather broad categories of structural practices and vegetative measures.

## **VEGETATIVE CONSERVATION MEASURES**

Vegetative practices may be applied singularly or in combination with other conservation measures. They may be either short lived or of a permanent nature. Sub-soils, mixtures of soils and soils with varying organic matter content, will be encountered when soil surfaces are disturbed. Unfavorable growth conditions such as acidity, low fertility, compaction and adverse moisture contents are often prevalent. These conditions are difficult to overcome but must be eliminated if adequate plant growth is to be obtained. A soil test will be essential to determining soil characteristics detrimental to plant growth. Steep gradients and long slopes are often present on areas to be vegetated. These areas are subject to erosive forces from rainfall impact and flowing water, and will require special techniques and grasses which will resist erosion. Establishing vegetation is possible with techniques and plants developed over the years.

**Temporary Vegetation.** In many instances, grading of areas is completed at a time when it is not practical to try to establish permanent vegetation. These areas can be stabilized by planting instead a variety of temporary annual grasses such as rye grass, rye, small grains and similar species. These temporary grasses will provide a rapid cover that can later be worked into the soil to provide organic matter when permanent vegetation is established. Every effort should be made to select temporary plants that will be compatible with the final permanent vegetation.

**Permanent Vegetation.** A wide selection of various grasses, legumes, ground cover, trees and shrubs can be used for permanent vegetation. If a high level of management is possible, an even wider range of plants can be used.

It is imperative that the final selection of plants be based on the adaptability of those plants to the topography and climate. Ease of establishment, life expectancy, maintenance requirements, aesthetics and any other special qualities should be considered. It is desirable to select plants requiring little maintenance. Many plants can be used to im-

prove the aesthetics of a site and still be effective soil stabilizers. Special attention should be given to steep cut and fill slopes where plants requiring little maintenance must be utilized.

**Mulching.** Due to time constraints, it may be impractical to stabilize an area with vegetation. Excellent temporary soil stabilization can be otherwise achieved using straw, hay, mulch with tackifier, rolled erosion control blankets (RECPs), hydraulically-applied erosion control products (HECPs) and synthetic fibers. Areas where final grade has been reached can be stabilized with mulch and over seeded at the proper time for permanent grasses. Mulches allow for greater infiltration of water into soil; reduce the amount of runoff; retain seeds, fertilizer and soil amendments in place; and improve soil moisture and temperature conditions. Mulch is essential in establishing good stands of grasses and legumes on disturbed areas. In order to prevent movement by wind or water, it is important that it be anchored to the soil.

Following are examples of vegetative practices suitable for utilization on disturbed land. A map code has been assigned to each practice and appears at the beginning of the title of each practice.

### **Bf - BUFFER ZONE**

A strip of undisturbed original vegetation, enhanced or restored existing vegetation, or the re-establishment of vegetation surrounding an area of disturbance or bordering streams, ponds, wetlands, lakes, and coastal waters.

### **Cs - COASTAL DUNE STABILIZATION (WITH VEGETATION)**

Planting vegetation on dunes that are denuded, artificially constructed, or re-nourished.

### **Ds1 - DISTURBED AREA STABILIZATION (WITH MULCHING ONLY)**

*Using plant residues or other suitable materials on the soil surface to reduce runoff and erosion, conserve moisture, prevent soil compaction and crusting, control undesirable vegetation, modify soil temperature and to increase biological activity in the soil.* This practice is applicable where stabilizing disturbed or denuded areas is not practical utilizing seeding or planting.

**EFFECTIVENESS OF GROUND COVER  
ON EROSION AND SEDIMENT CONTROL  
ON CONSTRUCTION SITES**

<b>Ground Cover Type</b>	<b>% Soil Loss Compared to Bare Soil</b>
Permanent grasses	99
Ryegrass (perennials)	95
Ryegrass (annuals)	90
Small grain	95
Millet or sudangrass	95
Grass sod	99
Hay (2 tons/acre)	98
Small grain straw (2 tons/acre)	98
Corn stalks (4 tons/acre)	98
Woodchips (6 tons/acre) <sup>2</sup>	94
Wood cellulose fiber (1 3/4 tons/acre) <sup>2</sup>	90

Other kinds of mulches that may be used are gravel, stones, temporary erosion control blanket, fibermatting, and excelsior.

Reference: USDA, Agricultural Research Service.

**Ds2 - DISTURBED AREA STABILIZATION  
(WITH TEMPORARY SEEDING)**

*A temporary vegetative cover with fast growing seedings for disturbed or denuded areas.* This practice is applicable for up to six months or until permanent vegetative cover can be installed. It should be coordinated with permanent measures to assure economical and effective stabilization. Techniques for establishing temporary cover utilizing both conventional and hydraulic seeding equipment are included.

**Ds3 - DISTURBED AREA STABILIZATION  
(WITH PERMANENT VEGETATION)**

*A permanent vegetative cover such as trees, shrubs, vines, grasses and legumes on disturbed or denuded areas.* It will apply on cut and fill

slopes, earth spillways, borrow areas, spoil areas and severely eroded or gullied lands. Techniques utilizing both conventional and hydraulic seeding equipment are discussed.

**Ds4 - DISTURBED AREA STABILIZATION  
(WITH SODDING)**

*A permanent vegetative cover using sods on highly erodible or critically eroded lands.* Sodds provide immediate ground cover and help filter sediments and nutrients.

**Du - DUST CONTROL ON DISTURBED AREAS**

*Controlling the surface and air movements of dust on construction sites, roadways and similar sites.* Methods and materials which can be used include mulches, vegetative cover, spray-on adhesives, mechanical manipulation of existing soil surfaces, irrigation, barriers, chemicals, and stone surface covers.

**FI-Co - FLOCCULANTS/COAGULANTS**

Flocculants and Coagulants are formulated to assist in the solids/liquid separation of suspended particles in solution. Such particles are characteristically very small and the suspended stability of such particles (colloidal complex) is due to both their small size and to the electrical charge between particles. Conditioning a solution to promote the removal of suspended particles requires chemical coagulation and/or flocculation.

**Sb - STREAMBANK STABILIZATION  
(USING PERMANENT VEGETATION)**

The use of readily available native plant materials to maintain and enhance streambanks, or to prevent, or restore and repair small streambank erosion problems.

**Ss - Slope Stabilization**

A protective covering used to prevent erosion and establish temporary or permanent vegetation on steep slopes, shore lines, or channels.

**Tac -TACKIFIERS**

*Substances used to anchor straw or hay mulch by causing the organic material to bind together.* Hay or straw will drift downslope unless anchored in place with tackifiers and binders. Tackifiers and binders reduce runoff and erosion as well as conserve moisture and prevent surface compaction.

## **STRUCTURAL CONSERVATION PRACTICES**

In some instances, vegetative cover and mulches alone will not provide sufficient protection from the erosive forces of water. In such cases, alternate structural practices can be used to curb erosion and sedimentation during land-disturbing activities. These practices should be planned and employed in a practicable combination with vegetative and mulching measures.

Structural practices must be adequately designed and properly installed to accomplish the desired objective. Design should be based on the appropriate storm discharge and velocities. Consideration should be given to the damage potential, safety hazards, planned life and required maintenance of each individual structural practice.

Following is an overview of standards and specifications for structural practices contained in Chapter 6 of this Manual.

### **Cd - CHECKDAM**

*A dam constructed across a swale or drainage ditch.* This is applicable for use in small channels which drain five (5) acres or less (not to be used in a live stream) in order to reduce erosion by slowing the velocity of concentrated storm water flows.

### **Ch - CHANNEL STABILIZATION**

*Improving, constructing or stabilizing a natural or artificial channel for conveying water flows.* In certain instances on selected development, it will be found that existing channels will not be adequate to convey desired discharges. New channels may be required to eliminate flooding. In many cases, existing channels cannot be considered stable. Therefore, this practice may be employed to assist in stabilizing these channels

### **Co - CONSTRUCTION EXIT**

*A stone-stabilized pad located at any point where vehicular traffic will be leaving a site onto a public right-of-way, street, roadway, or parking area.* Its purpose is to reduce or eliminate transportation of soil (by motor vehicles) from the construction area onto public rights-of-way.

### **Cr - CONSTRUCTION ROAD STABILIZATION**

*Roads, parking areas, and other transporta-*

*tion routes that are stabilized with coarse aggregate between the time of initial grading and final stabilization.* This travelway provides a fixed route for travel for construction traffic, reduces erosion, and subsequent regrading of permanent roadbeds, and provides a stable base for paving.

### **Dc - STREAM DIVERSION CHANNEL**

*A temporary channel that diverts a stream around a construction site to protect the streambed from erosion and allow work "in the dry".* This diversion is used when in-stream work is unavoidable, as with linear projects such as utilities or roads that frequently cross and impact live streams and create a potential for excessive sediment loss by both the disturbance of the approach areas and by the work within the streambed and banks.

### **Di - DIVERSION**

*An earth channel with a compacted supporting ridge on the lower side, constructed above, across, or below a slope.* The purpose of this practice is to reduce slope lengths, break-up concentrations of runoff, and move water to stable outlets at non-erosive velocities. Diversions should be designed to discharge water into established disposal areas.

### **Dn1 - TEMPORARY DOWNDRAIN STRUCTURE**

*A flexible conduit of heavy-duty plastic or other material used as a temporary structure to convey concentrations of stormwater down the face of a cut or fill slope.* Flexible downdrains are used on slopes where concentrations of stormwater would cause substantial erosion. They are removed once the permanent water disposal system is installed.

### **Dn2 - PERMANENT DOWNDRAIN STRUCTURE**

*A paved chute, pipe or a sectional conduit of prefabricated material designed to safely conduct surface runoff from the top to the bottom of a slope.* Downdrain structures are to be used where concentrated water will cause excessive erosion of cut and fill slopes.

### **Fr - FILTER RING**

*A temporary stone barrier used in conjunction with other sediment control measures and constructed to reduce flow velocities and filter sedi-*

ment. A filter ring can be installed at or around devices such as inlet sediment traps, temporary downdrain inlets, and detention pond retrofits to provide additional sediment filtering capacity.

#### **Ga - GABION**

*Large, rock-filled baskets wired together to form flexible monolithic building blocks.* They are used in channels, retaining walls, abutments, check dams, etc., to prevent erosion and sediment damage to a specific structure.

#### **Gr - GRADE STABILIZATION STRUCTURE**

*Structures of concrete, rock masonry, steel, aluminum, treated wood, etc.* They are installed to stabilize the grade in natural or artificial channels and to prevent the formation or advance of gullies and to reduce erosion and sediment pollution.

#### **Lv - LEVEL SPREADER**

*A storm flow outlet device constructed at zero grade across the slope whereby concentrated runoff may be discharged at a non-erosive velocity onto undisturbed areas stabilized by existing vegetation.* Concentrated flow of stormwater is converted to sheet flow at the level spreader.

#### **Rd - ROCK FILTER DAM**

*A temporary stone filter dam installed across drainageways or in conjunction with a temporary sediment trap.* This structure is installed to serve as a sediment-filtering device and to reduce storm water flow velocities. This practice may require a US Army Corps of Engineers permit.

#### **Re - RETAINING WALL**

*A constructed wall of concrete, masonry, reinforced concrete, cribbing, treated timbers, gabions, stone dry wall, riprap or other durable material.* They are installed to stabilize cut or fill slopes where maximum permissible slopes of earth are not obtainable. Each situation will require a specific design by a design engineer.

#### **Rt - RETROFITTING**

The physical modification of a storm water management outlet structure, using a half round corrugated metal pipe or similar device, to trap sediment contained in runoff water.

#### **Sd1 - SEDIMENT BARRIER**

*A temporary structure constructed of silt fences, straw or hay bales, brush piles, or other filtering materials.* They are installed to minimize and prevent sediment from leaving the site and entering natural drainage ways or storm drainage systems. They are not to be used on high-risk areas or where there will be a possibility of failure. **Silt fence shall not be installed across streams, waterways, or other concentrated flow areas.** Formal design is normally not required for sediment barriers.

#### **Sd2 - INLET SEDIMENT TRAP**

*A temporary protective device formed at or around an inlet to a storm drain to trap sediment.* They are employed to trap sediment in runoff water from small, disturbed areas. Clean out of these facilities is normally required after each heavy rainfall.

#### **Sd3 - TEMPORARY SEDIMENT BASIN**

*A basin created by an embankment or dam containing a principal spillway pipe and an emergency spillway.* These structures are normally situated within natural drainageways and at the lowest point on a construction site and are used to trap sediment contained in runoff water. Excavated basins may be employed where sites for embankment do not exist. Sediment basins serve only during the construction phase and are removed from the site when the disturbed area has been permanently stabilized.

Structure size will vary depending on the size of the drainage area, volume of sediments to be trapped, rainfall, structure location, etc. These structures can be regarded as being hazardous if constructed in areas of dense population. In these cases, it is advisable to protect them from trespassing.

Permanent sediment basins are designed to fit into the overall plan of the completed development. They may be converted to storm water retention facilities to reduce storm water discharges.

This specification does not apply to the design of permanent sediment basins.

#### **Sd4 - TEMPORARY SEDIMENT TRAP**

A small temporary pond that drains a disturbed area so that sediment can settle out. The

principle feature distinguishing a temporary sediment trap from a temporary sediment basin is the lack of a pipe or riser.

#### **Sk - FLOATING SURFACE SKIMMER**

A floating surface skimmer is a buoyant device that releases/drains water from the surface of sediment ponds, traps or basins at a controlled rate of flow. It “skims”, or dewater, from the water surface where sediment concentrations are at a minimum in the water column instead of draining from the bottom where sediment concentrations are their highest.

#### **SpB - SEEP BERM**

A seep berm is a linear control device constructed as a diversion perpendicular to the direction of the runoff to enhance dissipation and infiltration of runoff, while creating multiple sedimentation chambers with the employment of intermediate dikes.

#### **Sr - TEMPORARY STREAM CROSSING**

*A temporary structure installed across a flowing stream or watercourse for use by construction equipment.* The structure may consist of a pipe, bridge, or other suitable device permitting vehicular traffic without damaging stream banks and beds.

#### **St - STORM DRAIN OUTLET PROTECTION**

*A paved or short section of riprap channel placed at the outlet of a storm drain system.* The purpose is to reduce the velocity of water flows below storm drain outlets, and to prevent erosion from concentrated flow.

#### **Su - SURFACE ROUGHENING**

*Providing a rough soil surface with horizontal depressions created by operating a tillage or other suitable implement on the contour, or by leaving slopes in a roughened condition by not fine grading them.* This aids in the establishment of vegetation, reduction of runoff, and reduction of sediment.

#### **Tc -TURBIDITY CURTAIN**

A floating or staked barrier installed within the water. (It may also be referred to as a floating boom, silt barrier or silt curtain).

#### **Tp - TOPSOILING**

*Topsoiling areas to be vegetated by utilizing*

*a suitable quality soil.* The purpose is to provide a suitable soil medium for vegetative growth on areas where desired stands of vegetation are difficult to establish and maintain.

#### **Tr - TREE PROTECTION**

To protect desirable trees from injury during construction activity.

#### **Wt - VEGETATED WATERWAY OR STORMWATER CONVEYANCE CHANNEL**

*Outlets for diversions, terraces, berms, or other structures.* They may be natural or constructed, shaped to required dimensions, and paved or vegetated for disposal of storm water runoff. They may be of three general cross sections: parabolic, triangular, or trapezoidal. Parabolic waterways are the most commonly used. For waterways to be successful, it is essential that a protective cover of vegetation or other erosion protective measures be implemented. Flow velocities must be selected that will produce non-erosive flows within the waterway during peak discharges.

#### **CONSTRUCTION TECHNIQUES**

Other construction techniques may be employed by field personnel to assist in implementing an effective erosion control program. A few of these are discussed below.

- a. **Leave Exposed Soil Surfaces Rough.** Smooth soil surfaces will erode more readily than rough ones. Therefore, cut or fill slopes should not be “dressed” or smoothed until time to establish vegetation. Cut or fill slopes may be scarified or serrated using conventional earth moving equipment to provide this roughening effect. The cleated tracks of bulldozers are effective in compacting as well as roughening cut or fill slopes.
- b. **Selective Fill Placement.** Fills over culverts and conduits can be left in a condition to drain rain water to the upstream side of the culvert. This operation can be performed at the end of each construction day and will assist in retaining sediment on the site.
- c. **Selective Clearing.** Clearing operations should be confined to the removal of timber and heavy brush only. Ground covers consisting of small plants, weeds and organic matter should be retained until the start of the grading



operation.

- d. **Retain Natural Sediment Traps.** Small depressions in the land surface, natural creek berms and other natural sediment traps may be preserved in a natural state until such time as building sequences will require their alteration.
- e. **Retention of Natural Vegetation.** Natural Vegetation on disturbed area perimeters and adjacent to stream channels should be retained.

## **UNIFORM CODING SYSTEM**

The following coding system chart has been developed to provide statewide uniformity for erosion and sediment control plans. A code has been assigned to each practice. This code should appear at the desired location on the plan. In some instances, more than one code will appear. For example, an area planted in temporary vegetation will eventually be established to permanent seeding. Therefore, both codes should appear on the plans at the appropriate location. A symbol also has been assigned to most practices. For certain practices it will be necessary to place both the symbol and code letter on the plans.

To assist the user, a small detail drawing and a brief description of the major characteristics of the practice have been included on the coding system chart.

To increase the efficiency for all the agencies in erosion and sediment control and for the development community, this Manual includes a process for Alternative BMPs that are repeatedly used and approved under GSWCC Guidance to be placed on an Equivalent BMP List. This List is similar to the 5th Edition of the Manual's recognition of materials approved by the Georgia Department of Transportation (GDOT) that appear on GDOT's Qualified Products List (QPL). Refer to Appendix A-2 for information about joining the Equivalent BMP List.

# GEORGIA UNIFORM CODING SYSTEM

## FOR SOIL EROSION AND SEDIMENTATION CONTROL PRACTICES GEORGIA SOIL AND WATER CONSERVATION COMMISSION

### STRUCTURAL PRACTICES

CODE	PRACTICE	DETAIL	MAP SYMBOL	DESCRIPTION
Cd	CHECKDAM			A small temporary barrier or dam constructed across a swale, drainage ditch or area of concentrated flow.
Ch	CHANNEL STABILIZATION			Improving, constructing or stabilizing an open channel, existing stream, or ditch.
Co	CONSTRUCTION EXIT			A crushed stone pad located at the construction site exit to provide a place for removing mud from tires thereby protecting public streets.
Cr	CONSTRUCTION ROAD STABILIZATION			A travelway constructed as part of a construction plan including access roads, subdivision roads, parking areas and other on-site vehicle transportation routes.
Dc	STREAM DIVERSION CHANNEL			A temporary channel constructed to convey flow around a construction site while a permanent structure is being constructed.
Di	DIVERSION			An earth channel or dike located above, below, or across a slope to divert runoff. This may be a temporary or permanent structure.
Dn1	TEMPORARY DOWNDRAIN STRUCTURE			A flexible conduit of heavy-duty fabric or other material designed to safely conduct surface runoff down a slope. This is temporary and inexpensive.
Dn2	PERMANENT DOWNDRAIN STRUCTURE			A paved chute, pipe, sectional conduit or similar material designed to safely conduct surface runoff down a slope.
Fr	FILTER RING			A temporary stone barrier constructed at storm drain inlets and pond outlets.
Ga	GABION			Rock filter baskets which are hand-placed into position forming soil stabilizing structures.
Gr	GRADE STABILIZATION STRUCTURE			Permanent structures installed to protect channels or waterways where otherwise the slope would be sufficient for the running water to form gullies.
Lv	LEVEL SPREADER			A storm flow outlet device constructed at zero grade across the slope whereby concentrated runoff may be discharged at a non-erosive velocity onto undisturbed areas stabilized by existing vegetation.
Rd	ROCK FILTER DAM			A temporary stone filter dam installed across drainageways or in conjunction with a temporary sediment trap.
Re	RETAINING WALL			A wall installed to stabilize cut and fill slopes where maximum permissible slopes are not obtainable. Each situation will require special design.
Rt	RETRO FITTING			A device or structure placed in front of a permanent stormwater detention pond outlet structure to serve as a temporary sediment filter.
Sd1	SEDIMENT BARRIER			A barrier to prevent sediment from leaving the construction site. It may be sandbags, bales of straw or hay, brush, logs and poles, or a silt fence.
Sd2	INLET SEDIMENT TRAP			A temporary protective device formed at or around an inlet to a storm drain to trap sediment.
Sd3	TEMPORARY SEDIMENT BASIN			A basin created by excavation or a dam across a waterway. The surface water runoff is temporarily stored allowing the bulk of the sediment to drop out.
Sd4	TEMPORARY SEDIMENT TRAP			A small temporary pond that drains a disturbed area so that sediment can settle out. The principle feature distinguishing a temporary sediment trap from a temporary sediment basin is the lack of a pipe or riser.
Sk	FLOATING SURFACE SKIMMER			A buoyant device that releases/drains water from the surface of sediment ponds, traps, or basins at a controlled rate of flow.
SpB	SEEP BERM			A linear control device constructed as a diversion perpendicular to the direction of the runoff to enhance dissipation and infiltration of runoff, while creating multiple sedimentation chambers with the employment of intermediate dikes.

### STRUCTURAL PRACTICES

CODE	PRACTICE	DETAIL	MAP SYMBOL	DESCRIPTION
Sr	TEMPORARY STREAM CROSSING			A temporary bridge or culvert-type structure protecting a stream or watercourse from damage by crossing construction equipment.
St	STORMWATER OUTLET PROTECTION			A paved or short section of riprap channel at the outlet of a storm drain system preventing erosion from the concentrated runoff.
Su	SURFACE ROUGHENING			A rough soil surface with horizontal depressions on a contour or slopes left in a roughened condition after grading.
Tc	TURBIDITY CURTAIN			A floating or staked barrier installed within the water (it may also be referred to as a floating boom, silt barrier, or silt curtain).
Tp	TOPSOILING			The practice of stripping off the more fertile soil, storing it, then spreading it over the disturbed area after completion of construction activities.
Tr	TREE PROTECTION			To protect desirable trees from injury during construction activity.
Wt	VEGETATED WATERWAY OR STORMWATER CONVEYANCE CHANNEL			Paved or vegetative water outlets for diversions, terraces, berms, dikes or similar structures.

### VEGETATIVE PRACTICES

CODE	PRACTICE	DETAIL	MAP SYMBOL	DESCRIPTION
Bf	BUFFER ZONE			Strip of undisturbed original vegetation, enhanced or restored existing vegetation or the reestablishment of vegetation surrounding an area of disturbance or bordering streams.
Cs	COASTAL DUNE STABILIZATION (WITH VEGETATION)			Planting vegetation on dunes that are denuded, artificially constructed, or re-nourished.
Ds1	DISTURBED AREA STABILIZATION (WITH MULCHING ONLY)			Establishing temporary protection for disturbed areas where seedlings may not have a suitable growing season to produce an erosion retarding cover.
Ds2	DISTURBED AREA STABILIZATION (WITH TEMP SEEDING)			Establishing a temporary vegetative cover with fast growing seedlings on disturbed areas.
Ds3	DISTURBED AREA STABILIZATION (WITH PERM SEEDING)			Establishing a permanent vegetative cover such as trees, shrubs, vines, grasses, or legumes on disturbed areas.
Ds4	DISTURBED AREA STABILIZATION (SODDING)			A permanent vegetative cover using sods on highly erodible or critically eroded lands.
Du	DUST CONTROL ON DISTURBED AREAS			Controlling surface and air movement of dust on construction site, roadways and similar sites.
Fl-Co	FLOCCULANTS AND COAGULANTS			Substance formulated to assist in the solids/liquid separation of suspended particles in solution.
Sb	STREAMBANK STABILIZATION (USING PERM VEGETATION)			The use of readily available native plant materials to maintain and enhance streambanks, or to prevent, or restore and repair small streambank erosion problems.
Ss	SLOPE STABILIZATION			A protective covering used to prevent erosion and establish temporary or permanent vegetation on steep slopes, shore lines, or channels.
Tac	TACKIFIERS AND BINDERS			Substance used to anchor straw or hay mulch by causing the organic material to bind together.

# CHAPTER 3

## PLANNING AND PLANS

### SECTION I - PLANNING

Planning is the critical process by which land-disturbing activities are formulated. The planning process for activities governed by Act 599 can be broken down into the following four progressive stages:

1. preliminary site investigations
2. preliminary design
3. subsurface investigation
4. final design

For many small land-disturbing activities, steps one and two are sometimes combined but planning for major developments normally follows these four steps.

To be successful, a plan must include measures for efficient scheduling and coordination of construction activities and provisions for the maintenance of conservation practices. Stormwater management facilities should be included to reduce the impact of stormwater runoff to on-site facilities both during and after construction is completed. It is *desirable* to include stormwater retention structures. Land-disturbing activities normally will result in an increase in runoff from the site. Stormwater management structures will reduce the impact of damages on downstream facilities resulting from an increase in runoff.

Many of the Local Issuing Authorities in the State have a Stormwater Ordinance. The design professional should consult with the LIA before designing the construction plans. The Georgia Stormwater Management Manual is available for download at [www.georgiastormwater.com](http://www.georgiastormwater.com).

### PLANNING STAGES

**Preliminary Site Investigation Stage.** The first consideration in the preliminary site investigation stage should be the assimilation of all available resource information. This information will assist the planners in identifying critical physical features of the site which would have significant impact on erosion and sediment control. Delineation of flood-prone areas and areas which would have a high aesthetic value if protected

can be identified. Sources of resource information are included in Chapter 5 of this Manual.

A conservation planning base map should be prepared utilizing all information available. The final step would be a detailed *on-site inspection*. At this time, base maps should be thoroughly checked for accuracy.

O.C.G.A. § 12-7-9, requires certification stating that the plan preparer or the designee thereof visited the site prior to creation of the plan or that such a visit was not required in accordance with rules and regulations established by the board.

GA EPD Rule 391-3-7-.10 Site Visit Required.

- (1) All applications shall contain certification stating that the plan preparer or his or her designee has visited the site prior to creation of the plan.
- (2) plans submitted shall contain the following certification: "I certify under penalty of law that this Plan was prepared after a site visit to the location described herein by myself or my authorized agent, under my direct supervision."

**Preliminary Design Stage.** In the preliminary design stage, a thorough analysis of the information assembled during the preliminary site investigation stage should be accomplished. The objective of the analysis is to determine how the proposed site can be best utilized as intended without causing undue harm to the environment. Areas particularly vulnerable to erosion and sedimentation because of existing topography, soils, vegetation or drainage should be identified. The planner is encouraged to use available soils information in his site analysis. A discussion of the use of soils information in site planning follows in this chapter.

**Subsurface Investigation Stage.** A subsurface investigation should be accomplished to determine the geological features and the nature and properties of the soils present on the site. A detailed on-site soils investigation will be necessary for the design of complex buildings, roadways, and other engineering structures. Facilities that will be serviced by septic tanks will require on-site testing. The stability of slopes should be determined based on soils analysis. Groundwater problems should

be identified at this time. Soils subject to water flows should be analyzed for permissible velocities. Soils to be established in vegetation should be examined for pH, nutrient levels and ease of establishing vegetation. Methods of overcoming soils limitations should be explored.

**Final Design Stage.** Final designs should be based on detailed engineering surveys, subsurface investigations and sound conservation and engineering principles. Permanent buildings, roadways and engineering structures should be fitted to the topography and soil types. Efficient, durable and easily maintained erosion control measures should be employed. Sediment basins, barriers and traps should be designed to trap sediment which would be transported from the site. All stormwater facilities should be of adequate capacity and have the ability to withstand peak velocities. Filling or development within flood-prone areas should be avoided except those activities necessary to promote public health and welfare. If, for example, roadway crossings are made, openings must be sized to eliminate undue restriction in water flows and excessive downstream velocities. Natural vegetation and open space should be provided. Finally, rigid construction scheduling should be employed.

## SOILS INFORMATION AND SITE PLANNING

An invaluable tool in planning for land disturbing activities is soils information available through USDA Natural Resources Conservation Service (NRCS). Soil scientists study, evaluate, classify and map soils in counties throughout Georgia and publish soil surveys with maps and descriptions.

Published soil surveys have been digitized and can be accessed through the Web Soil Survey. The Web Soil Survey is an interactive, internet based application that contains soil maps and associated attribute data from soil surveys produced by the National Cooperative Soil Survey. Spatial and attribute data are available on the Web Soil Survey for all Georgia counties that have a completed, correlated soil survey, which currently includes most, but not all Georgia counties. Further information about how to use the Web Soil Survey and the information it contains is in Appendix B-1 of the Manual. A status map of Georgia counties with spatial data available can be found on the Soil Data Mart, <http://soildatamart.nrcs.usda.gov/Statusmap.aspx>.

Soil maps and supporting data provide information about important soil properties, including the following:

**Flood Hazards** - Soil surveys show areas that are subject to flooding. Although this information is not a substitute for hydrologic surveys, which determine the limits of flooding on the basis of the severest flood expected once in 10, 25, 50 or 100 years, it does provide a good first approximation of the flood-prone areas.

**Wetness** - Soil surveys show if the soil is well drained, poorly drained, or seasonally waterlogged, and if the water table is seasonally high. The rating of the permeability of soils is also included.

**Bearing Capacity** - Soil surveys provide test data and estimates of the physical properties of soils that enable engineers to make sound judgments about bearing capacities for shallow foundations. Major soil layers to a depth of about 5 feet are classified in both the United and the AASHTO systems. Data is also given on grain-size distribution and expansiveness for each soil layer.

**Depth to Rock** - Soil surveys show locations where bedrock is at depths of less than 5 or 6 feet and describe the geologic material that underlies the soil.

**Shrink-swell and Slippage** - Soil properties that result in high swelling pressures, mainly the kind and amount of clay, are given in soil surveys. Soil surveys also indicate soil properties that make soils unstable and susceptible to slippage.

## THE REVISED UNIVERSAL SOIL LOSS EQUATION

RUSLE1 was first released for widespread use in late 1992 as version 1.02. Improved versions of RUSLE were periodically released to cover errors and to give RUSLE increased capability. Previous versions of RUSLE were available for a fee from the Soil and Water Conservation Society (SWCS) through a Cooperative Research and Development Agreement with the Agricultural Research Service (ARS) of the United States Department of Agriculture (USDA) that gave the SWCS a copyright on RUSLE1. That agreement expired in 1996. The last version of RUSLE1 covered by that agreement was RUSLE1.05. Version 1.06c is not covered by

the copyright and can be freely downloaded by anyone who wishes to use it.

NRCS is now implementing RUSLE2 in its field offices as a replacement for RUSLE1. RUSLE2 uses physically meaningful input values that are widely available in existing databases or can be easily obtained. It is believed to be the best available practical erosion prediction technology that can be easily applied at the local office level.

RUSLE2 computes net detachment each day using a variation of the familiar RUSLE factors:

$$a = r k l S c p$$

Where:

a = net detachment (mass/unit area)

r = erosivity factor

k = soil erodibility factor

l = slope length factor

S = slope steepness factor

c = cover-management factor

p = supporting practices factor

The lower case symbols represent daily values. Upper case symbols used in the USLE and RUSLE1 represent annual values. Each factor, except the slope steepness factor S, in the above equation change daily and as cover-management conditions change with specific events, like soil-disturbing operations. **Although the values used for each factor are daily values, they represent long-term average conditions for that day.**

The key element in this equation is the product of rk, which produces a daily sediment production estimate for unit-plot conditions. The variables r and k have units so that the product rk has **absolute units** of mass/area. The other variables in this equation adjust the unit-plot sediment production value to reflect differences between unit-plot conditions and site-specific field conditions. The factors l, S, c, and p are **ratios** of sediment production from the given field condition to unit-plot conditions and do not have units.

RUSLE1.06c and RUSLE2 can both be freely accessed at: <http://www.ars.usda.gov/Research/docs.htm?docid=5971>.

Design professionals of land disturbing activities should specify that the estimated erodibility of subsurface soil be obtained during site borings,

because of the natural range and variability of soil properties. Additional information about soils and their properties, use, and interpretation can be found in the Web Soil Survey, as described in Appendix B-1.

## SECTION II - PLANS

Sample erosion control plans are available for review on the GSWCC website at <https://gaswcc.georgia.gov/>.

It should be emphasized that the methodology utilized in this example is only one of many available to the designer or planner. Many other practical combinations of erosion control measures could have been employed to effectively reduce erosion on this site.

### LAND DISTURBING ACTIVITY PLAN

Any land disturbing activity which disturbs one acre or greater, is not a part of a larger common plan of development, and is not exempt from the Act as listed on page 1-3 in Chapter 1 of this Manual, must have an Erosion and Sediment Control (E&SC) Plan. Any land disturbing activity which disturbs less than one acre, and is within 200' of a perennial stream must also have an E&SC Plan.

The State of Georgia also requires most land disturbing activities disturbing one acre or greater to obtain coverage under the National Pollutant Discharge Elimination System (NPDES) Permits. There are currently three NPDES Permits for construction projects in Georgia:

1. GAR100001 For Stand Alone Projects
2. GAR100002 For Infrastructure Projects
3. GAR100003 For Common Developments

The NPDES Permits require the permittee to have an Erosion, Sedimentation and Pollution Control (ES&PC) Plan. The GSWCC and the GA EPD have compiled a plan review checklist for each of the three permits that list all the requirements for all plans to be in compliance with the Act and the NPDES Permits.

Projects that disturb less than one acre and are within 200' of a perennial stream are not exempt from the Act, but are exempt from NPDES. Items

on the Stand Alone and Infrastructure checklists that do not apply when NPDES is not applicable are indicated on the checklists.

All ES&PC Plans must be prepared by a design professional licensed by the State of Georgia in the field of engineering, architecture, landscape architecture, forestry, geology, or land surveying; or a person that is a Certified Professional in Erosion and Sediment Control (CPESC) with a current certification by Certified Professional in Erosion and Sediment Control Inc\*. All design professionals and plan reviewers of an ES&PC Plan must have a current Level II certification issued by the GSWCC.

NPDES Permits and Fee Schedule, Notice of Intent (NOI) for all permittees, and Notice of Termination (NOT) for all permittees can be downloaded from the EPD or the GSWCC website. Certification criteria and classes can be found on the GSWCC website.

\*A CPESC certification is offered by EnviroCert International, for additional information please visit [www.cpesc.org](http://www.cpesc.org).

Legend

- Modern Published Soil Survey (1966 or newer)
- Old Published Soil Survey (1966 or newer)
- Modern Soil Survey with field mapping complete, to be published
- Modern Soil Survey being conducted, with completion date set
- Mapping and publication plans incomplete
- Soil Survey update in progress
  - (1) Interpretation update available
  - (2) Interim report available
- Soil Survey update completed

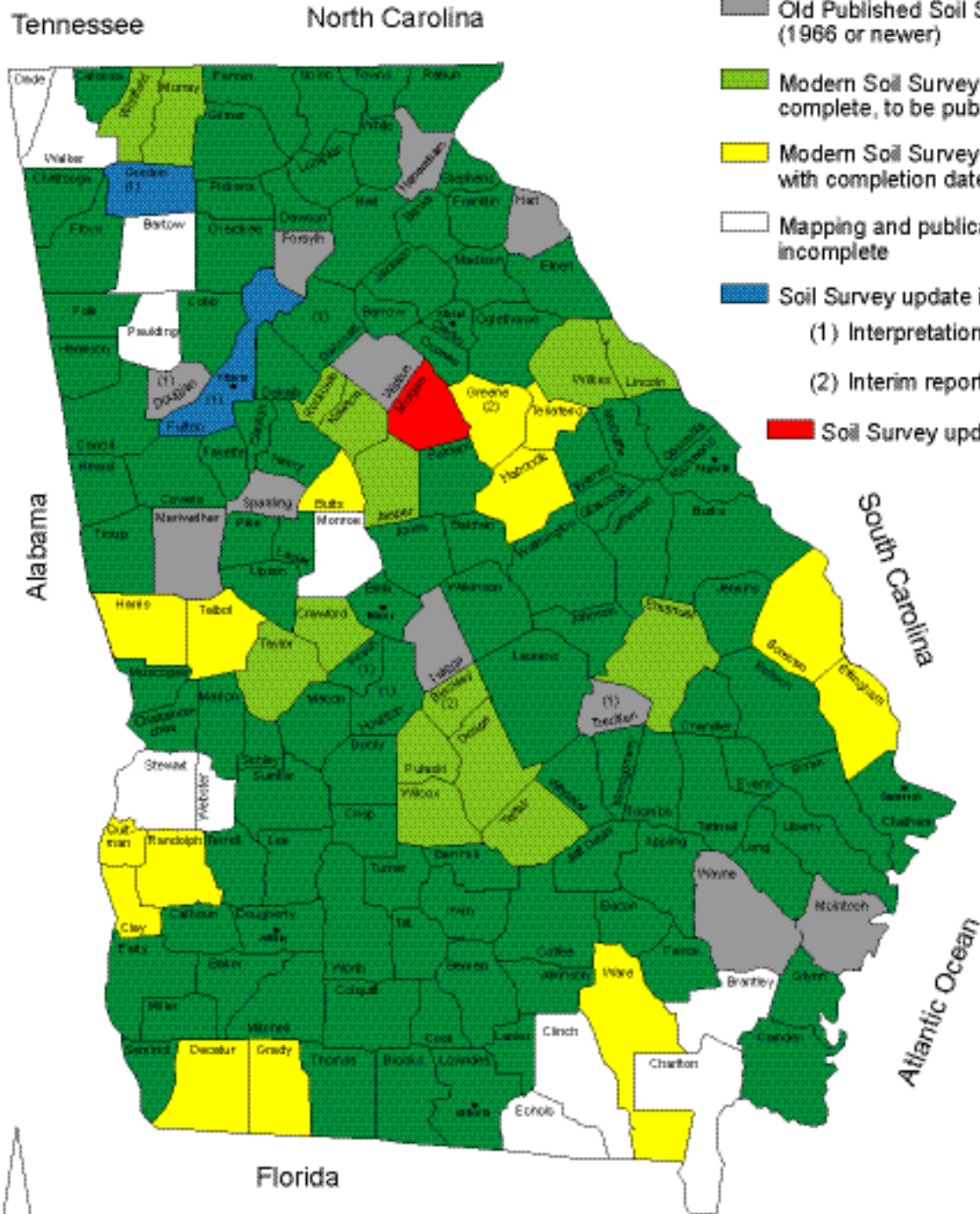

**STATUS OF SOIL SURVEYS  
GEORGIA  
December 1997**

Source:  
Information provided by NRCS field personnel  
Natural Resources Conservation Service, Athens, GA 1997

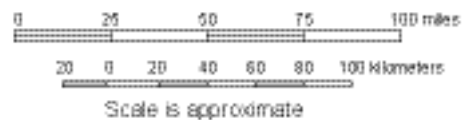





PAGE 7 -38 ARE RESERVED FOR SAMPLE ES&PC PLAN

THESE PAGES ARE PLACE HOLDERS

PAGE 7 -38 ARE RESERVED FOR SAMPLE ES&PC PLAN

THESE PAGES ARE PLACE HOLDERS

PAGE 7 -38 ARE RESERVED FOR SAMPLE ES&PC PLAN

THESE PAGES ARE PLACE HOLDERS

PAGE 7 -38 ARE RESERVED FOR SAMPLE ES&PC PLAN

THESE PAGES ARE PLACE HOLDERS

PAGE 7 -38 ARE RESERVED FOR SAMPLE ES&PC PLAN

THESE PAGES ARE PLACE HOLDERS

PAGE 7 -38 ARE RESERVED FOR SAMPLE ES&PC PLAN

THESE PAGES ARE PLACE HOLDERS

PAGE 7 -38 ARE RESERVED FOR SAMPLE ES&PC PLAN

THESE PAGES ARE PLACE HOLDERS





PAGE 7 -38 ARE RESERVED FOR SAMPLE ES&PC PLAN

THESE PAGES ARE PLACE HOLDERS



PAGE 7 -38 ARE RESERVED FOR SAMPLE ES&PC PLAN

THESE PAGES ARE PLACE HOLDERS



PAGE 7 -38 ARE RESERVED FOR SAMPLE ES&PC PLAN

THESE PAGES ARE PLACE HOLDERS



PAGE 7 -38 ARE RESERVED FOR SAMPLE ES&PC PLAN

THESE PAGES ARE PLACE HOLDERS





PAGE 7 -38 ARE RESERVED FOR SAMPLE ES&PC PLAN

THESE PAGES ARE PLACE HOLDERS



PAGE 7 -38 ARE RESERVED FOR SAMPLE ES&PC PLAN

THESE PAGES ARE PLACE HOLDERS



PAGE 7 -38 ARE RESERVED FOR SAMPLE ES&PC PLAN

THESE PAGES ARE PLACE HOLDERS



PAGE 7 -38 ARE RESERVED FOR SAMPLE ES&PC PLAN

THESE PAGES ARE PLACE HOLDERS





PAGE 7 -38 ARE RESERVED FOR SAMPLE ES&PC PLAN

THESE PAGES ARE PLACE HOLDERS



# Coordinating Erosion and Sediment Control With Post-Construction Stormwater Management

## Introduction

It is essential to coordinate post-construction stormwater planning with the design and implementation of Erosion Sedimentation and Pollution Control (ES&PC) Plans. This chapter provides general guidance on this coordination. Post-construction stormwater management in Georgia is largely governed by:

- The Georgia Stormwater Management Manual (Volumes 1 and 2, 2001)
- The Georgia Coastal Stormwater Supplement (2009)

**However, it is crucial for plan preparers to also check local requirements for local adaptations to post-construction stormwater requirements.**

Before proceeding, it may be helpful to provide some simple definitions in order to distinguish what is meant by “erosion and sediment control” and “post-construction stormwater” in the context of this section:

## EROSION & SEDIMENTATION CONTROL (ES&PC) PLANS:

The application of planning approaches and practices during the construction phase in accordance with Act 599 and the Manual for Erosion and Sediment Control in Georgia. These practices generally apply during the active construction phase of a land disturbing activity, including land clearing, filling, excavation, soil movement, construction, and other activities defined in the Act. It should be noted that construction phase plans and practices must also be coordinated with other applicable permits, such as the NPDES General Permits for Discharge from Construction Activities and, for MS4 communities, minimum measure #4.

## POST-CONSTRUCTION STORMWATER:

The term post-construction stormwater is used to distinguish stormwater practices used during the active construction phase (sometimes referred to as “construction stormwater”) from those that are used on a permanent basis to control runoff once construction is complete (“post-construction stormwater”).

Post-construction stormwater includes site planning and structural and non-structural practices that intercept, treat, and often reduce the volume of runoff from land development sites.

Collectively, these practices are referred to as “post-construction BMPs (Best management practice).” As with construction, other permits may apply, such as MS4 minimum measure #5.

Recent trends in post-construction stormwater management that make ES&PC Plan coordination all the more important include:

- The use of better site design and green infrastructure techniques to help satisfy post-construction stormwater requirements. These approaches involve the use of open space, vegetated areas, impervious cover disconnection, and other site planning and design techniques. For the ES&PC Plan, this can mean more “do not disturb” zones and the need to avoid disturbing and compacting soils in dispersed areas around a development site.
- The use of small-scale, distributed (low-impact development) practices that treat runoff closer to its source. Many of these practices rely on the underlying soil to infiltrate at least part of the runoff. Some may be on individual lots, within community open space, or within drainage easements. For the ES&PC Plan, this means a finer level of control for the limits of disturbance so that the performance of the ultimate post-construction practices is not compromised during the construction phase.
- More elaborate design parameters for stormwater ponds and wetlands that may begin their lives as ES&PC basins. Often, the post-construction configuration will involve pretreatment forebays, flowpath and

geometry requirements, multi-stage riser structures, and other features that the designer must consider when designing the initial ES&PC basin. A detailed conversion plan is needed for the practice to successfully meet both ES&PC and post-construction needs.

All of these trends make it essential for a higher level of coordination during site planning and implementation of ES&PC Plans in the field.

There are several key principles that apply to the coordination between ES&PC and post-construction stormwater, as outlined below:

**Principle #1: Limits on the Limits of Disturbance (LOD):**

The LOD on the ES&PC Plan must respect natural areas, open spaces, undisturbed vegetated areas, and the footprints of certain BMPs that are part of the post-construction stormwater plan. LODs that make sense for only the construction phase can compromise the integrity of the post-construction approach. Also, LOD boundaries may need more careful fencing, signage, and monitoring during construction.

**Principle #2: Soil Structure as a Post-Construction Stormwater Tool:**

Many post-construction practices rely on the underlying soil structure to allow the BMPs to function as designed. This is obviously true for practices designed to infiltrate runoff, but also applies to post-construction BMPs that have an underdrain (e.g., some bioretention, dry swale, and porous pavement designs). Care must be taken during the construction phase to avoid compacting soils in the vicinity of post-construction BMP installations.

**Principle #3: Diversions:**

In many cases, construction runoff can seriously compromise post-construction BMPs, even before they are installed. Sediment-laden construction runoff can damage soils intended for infiltration or filtration and can clog rock and other materials intended for use in the post-construction BMP. As such, the ES&PC Plan should include diversions to prevent construction runoff from entering certain areas associated with post-construction BMP implementation.

**Principle #4: Conversion Details:**



In many cases, ES&PC and post-construction practices can be co-located. This has advantages in terms of the efficiency of the design, and can also help the post-construction BMP because the conversion cannot take place until the erosion control function is complete (thus avoiding premature installation of the post-construction features). However, given the increasingly sophisticated nature of post-construction BMP design, a detailed conversion plan is needed as part of the ES&PC Plan to make sure that post-construction volumes, BMP geometry, riser configuration, access, and other features are adhered to. The conversion plan should also be very specific about the timing and sequencing of conversion activities with ongoing land disturbance and stabilization.

**Principle #5: Communication & Coordination:**

In order to coordinate erosion and sediment control with post-construction stormwater, a local program should strive to integrate activities such as plan review, site inspections, administration of performance bonds, adoption of technical standards and policies, and training and communication for the regulatory community.

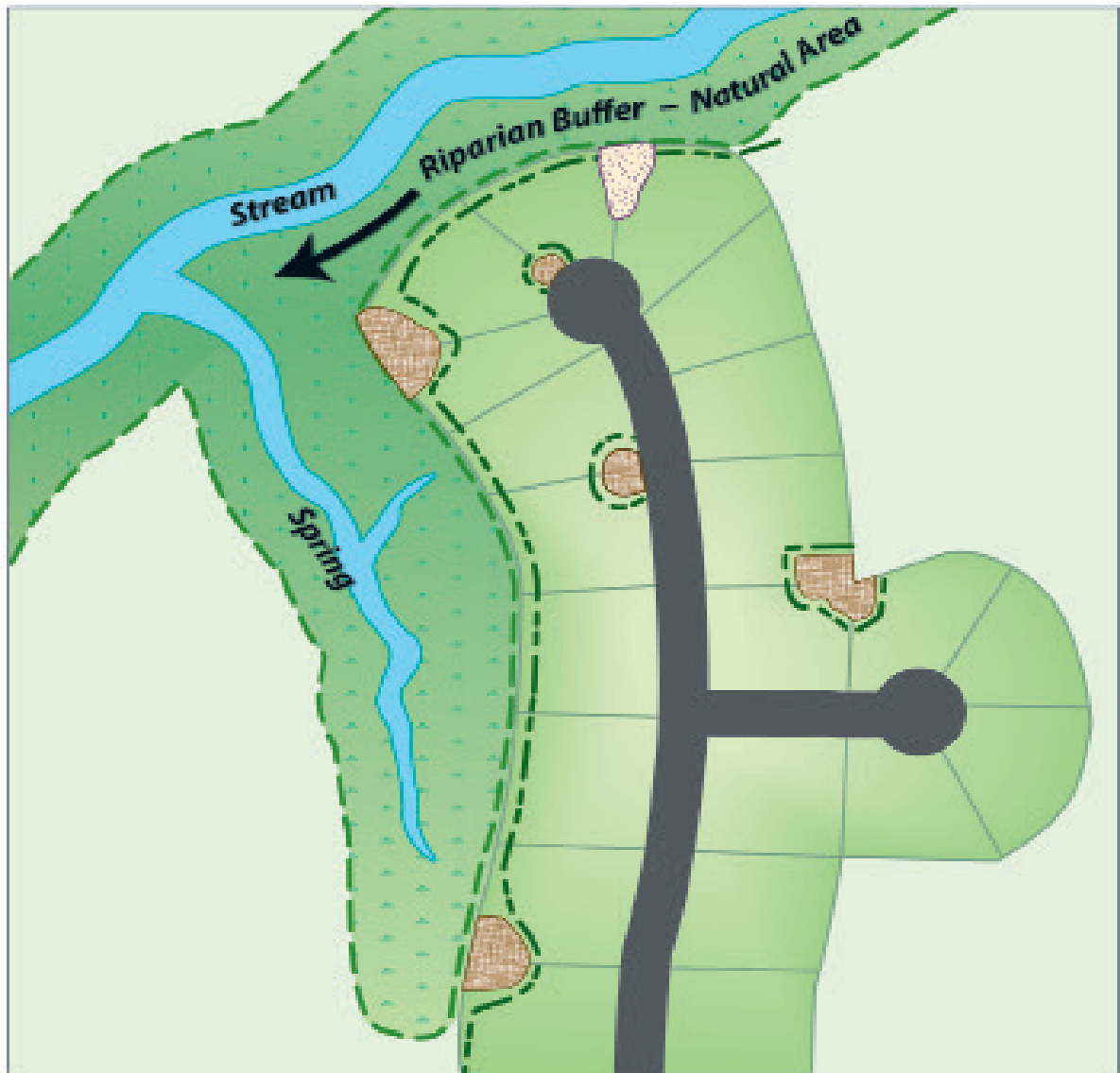
Figure 1 shows several typical points of coordination between ES&PC and post-construction stormwater.



-  Riparian Buffer/Natural Area Boundary
-  Co-Located construction-phase sediment basin and post-construction BMP
-  Post-construction bioretention/infiltration area — Soil must be protected during construction. Do **not** use for construction-phase BMPs
-  Limits of Disturbance (LOD) for construction-phase SWPPP — Must protect Riparian Buffer and post-construction infiltration area. Fencing recommended.

From: Managing Stormwater in Your Community, EPA Publication No.: 833-R-08-001 (CWP, 2008)

**Erosion & Sediment Control  
Considerations When Using Post-Construction Practices From  
Georgia’s Stormwater Manuals**

Tables 1 and 2 provide more specific guidance on ES&PC considerations for practices and BMPs contained in both the Georgia Stormwater Management Manual (GSMM) and Georgia Coastal Stormwater Supplement (CSS):

**Table 1** Provides ES&PC considerations for post-construction practices related to natural resources protection, better site design, and other site planning practices that are authorized or used to obtain post-construction credits in the GSMM and CSS.

**Table 2** Lists similar considerations for structural post-construction BMPs, such as bioretention, porous pavement, vegetated swales, infiltration trenches, and stormwater ponds and wetlands.

<b>Table 1. ES&amp;PC Considerations for Specific Natural Resource Protection &amp; Site Planning Practices in the GSMM &amp; CSS</b>		
<b>Natural Resource or Site Planning Practice</b>	<b>Reference to the GSMM &amp; CSS</b>	<b>ES&amp;PC Considerations</b>
Natural Area Conservation: Protect floodplains, slopes, porous/erodible soils, aquatic resources, groundwater recharge zones	GSMM: Volume 1: Section 4.5.2  Volume 2: Sections 1.4.1 & 1.4.2 (various practices)  CSS : Section 7.6.1 & 7.6.2	<ul style="list-style-type: none"> <li>•Clearly identify all natural resources area boundaries on ES&amp;PC Plans as being outside of the LOD.</li> <li>•Specify use of temporary construction fencing at LOD.</li> <li>•Diversions or other measures may be needed to divert construction runoff away from the area.</li> <li>•Install temporary fencing and signage at the beginning of land disturbing activities.</li> <li>•Monitor construction activities to ensure that heavy equipment does not enter natural resource areas.</li> </ul>
Stream/Riparian Buffers: Protect or restore vegetated area adjacent to streams and aquatic resources	GSMM: Volume 1: Section 4.5.3  Volume 2: Section 1.4.2 (Practice #2)  CSS : Section 7.6.1 & 7.6.2	<ul style="list-style-type: none"> <li>•Clearly identify all stream buffer boundaries on ES&amp;PC Plans as being outside of the LOD.</li> <li>•See above for other guidelines under “Natural Area Conservation.”</li> </ul>

**Table 1. ES&PC Considerations for Specific Natural Resource Protection & Site Planning Practices in the GSMM & CSS (continued)**

Natural Resource or Site Planning Practice	Reference to the GSMM & CSS	ES&PC Considerations
<p>Disconnection of post-construction Impervious Cover: direct impervious cover to downgradient pervious areas as sheet flow or over-land flow filter paths</p>	<p>GSMM: Volume 1: Section 4.5.5</p> <p>Volume 2: Section 1.4.2 (Practices #17, 20) ;</p> <p>Section 3.3.1 (Filter Strip)</p> <p>CSS : Sections 7.8.5 &amp; 7.8.6</p>	<ul style="list-style-type: none"> <li>•Identify on ES&amp;PC Plans all pervious areas that will receive runoff from upgradient impervious or developed areas.</li> <li>•Avoid compaction of pervious areas with heavy equipment during construction; use temporary fencing as necessary.</li> <li>•Diversions or other measures may be needed to divert construction runoff away from the pervious areas.</li> <li>•Make sure that all subcontractors know about the areas.</li> <li>•It is acknowledged that it may not be practical to prevent disturbance or compaction of ALL of these pervious receiving areas on a site (e.g., small areas on individual lots). Pervious receiving areas that ARE compacted during construction should be restored by tilling and adding compost, as per Section 7.8.1 of the CSS or similar guidance.</li> </ul>
<p>Grass/Vegetated Channels: direct runoff from developed areas to vegetated channels instead of storm sewer systems</p>	<p>GSMM: Volume 1: Section 4.5.4</p> <p>Volume 2: Section 1.4.2 (Practice #18, 19) ;</p> <p>Section 3.3.2 (Grass Channel)</p> <p>CSS: Section 7.8.7</p>	<ul style="list-style-type: none"> <li>•Similar to Impervious Cover Disconnection, vegetated/grass channels and drainageways should be identified on ES&amp;PC Plans and marked in the field to avoid disturbance and compaction.</li> <li>•Of course, roadside channels will be disturbed during construction; soil restoration should follow post-construction plans.</li> </ul>
<p>Other Better Site Design Practices that Reduce Site Grading &amp; Disturbance: reduce limits of clearing, reduce impervious cover, more compact development design</p>	<p>GSMM: Volume 1: Section 4.3</p> <p>Volume 2: Section 1.4</p> <p>CSS : Section 7.7</p>	<ul style="list-style-type: none"> <li>•Ensure that reduced development footprint translates to ES&amp;PC Plan by matching limits of disturbance with post-construction design and layout.</li> <li>•Clearly mark limits of disturbance; use temporary construction fencing as necessary.</li> </ul>

Table 2. ES&PC Considerations for Specific Structural Post-Construction BMPs in the GSMM & CSS		
Post-Construction BMP	Reference to the GSMM & CSS	ES&PC Considerations
Bioretention, Infiltration, Porous Pavement WITHOUT an underdrain system (designed for infiltration into underlying soils)	<p>GSMM Volume 2: Sections 3.2.3 (Bioretention), 3.2.5 (Infiltration), 3.3.7 (Porous Concrete), 3.3.8 (Modular Porous Pavement System)</p> <p>CSS : Sections 7.8.4 (Permeable Pavements), 7.8.9 (Rain Gardens), 7.8.11 (Dry Wells), 7.8.13 (Bioretention), 7.8.14 (Infiltration), 8.6.6 (Swales)</p>	<ul style="list-style-type: none"> <li>•Clearly show post-construction practice footprints on ES&amp;PC Plan. Usually, these areas should be outside of the LOD (with the exception of porous pavement), unless they are used as small, temporary sediment traps as per the guidelines in Table 3.</li> <li>•Mark practice footprint areas in the field with temporary fencing and signage.</li> <li>•Monitor construction activities to ensure that heavy equipment does not enter practice footprint areas.</li> <li>•All contributing drainage areas (CDAs) to the practice MUST be fully stabilized and vegetated prior to installation of post-construction BMP.</li> <li>•In addition, runoff from the CDA can be diverted around the post-construction BMP footprint and supplemental ES&amp;PC measures (e.g., silt fence/barriers around the perimeter of the practice) can be used to prevent erosion into the practice from the CDA or practice side slopes as they are being graded.</li> </ul>
Bioretention, Dry Swale, Infiltration, Porous Pavement WITH an underdrain system (designed for underdrain to discharge to storm sewer)	<p>GSMM Volume 2: Sections 3.2.3 (Bioretention), 3.2.6 (Enhanced Swales)</p> <p>CSS: Sections 7.8.4 (Permeable Pavements), 7.8.13 (Bioretention), 7.8.10 (Stormwater Planters), 7.8.15 (Dry Swales)</p>	<ul style="list-style-type: none"> <li>•Clearly show post-construction practice footprints on ES&amp;PC Plan. Usually, these areas should be outside of the LOD (with the exception of porous pavement), unless they are used as small, temporary sediment traps as per the guidelines in Table 3.</li> <li>•If outside of the LOD, mark practice footprint areas in the field with temporary fencing and signage.</li> <li>•Monitor construction activities to ensure that heavy equipment does not enter practice footprint areas.</li> <li>•Similar to practices without underdrains, the CDA must be stabilized and supplemental ES&amp;PC measures (e.g., silt fence/barriers around the perimeter of the practice) can be used to prevent sediment from entering the post-construction BMP.</li> </ul>



**Table 2. ES&PC Considerations for Specific Structural Post-Construction BMPs in the GSMM & CSS (Continued)**

Post-Construction BMP	Reference to the GSMM & CSS	ES&PC Considerations
Conversions from temporary ES&PC practice to post-construction BMP	GSMM Volume 2: Sections 3.2.1 (Stormwater Ponds) 3.2.2 (Stormwater Wetlands) CSS: Sections 8.6.1 (Stormwater Ponds) 8.62 (Stormwater Wetlands)	<ul style="list-style-type: none"> <li>•For post-construction stormwater designs that include stormwater ponds or wetlands, it is likely that the practice will be installed initially as a temporary ES&amp;PC basin.</li> <li>•ES&amp;PC Plans should incorporate the design considerations outlined in the following section on co-locating and converting ES&amp;PC practices to post-construction BMPs.</li> <li>•The timing of conversion from temporary to permanent practices depends on exposed areas and continued land disturbance in the CDA. The ES&amp;PC Plan should have a detailed phasing plan that clearly explains this sequence.</li> </ul>

**Co-Locating & Converting ES&PC Practices to Post-Construction BMPs**

Previous sections discuss the prospect of co-locating ES&PC and post-construction practices. While this cannot be done in all cases, it is an acceptable approach as long as certain guidelines are followed to ensure the integrity of the post-construction BMP. In addition, there are some notable advantages to co-locating practices, the chief one being that the post-construction conversion cannot take place until the construction-phase ES&PC function is complete. This is important because one of the chief causes of failure for post-construction BMPs is premature installation and the introduction of construction sediments into the practice. There are many bio-retention, infiltration, and other practices where this has been a serious concern. See Figure 2 for examples.

The other advantage for co-location is that it is straight-forward, can be implemented easily by the contractor, and may lead to cost savings.

Given these advantages to co-location, there are circumstances where it should not be done, including:

- Post-construction BMPs that have too small of a drainage area and/or are in a location that is not conducive for an ES&PC trap.

- Post-construction BMPs where the local plan reviewer deems that construction activity will compact and damage underlying soils to an extent that performance of the post-construction BMP will be compromised.
- Post-construction BMPs where timing and sequencing of construction phases will not allow the conversion to take place in the proper sequence so that the practice cannot fulfill its post-construction treatment objectives.
- Other situations where the local authority, plan reviewer, designer, and/or contractor believes that co-location will compromise the ES&PC and/or post-construction plan implementation.

Where co-location is a viable option, there are generally two types of practices where conversion from ES&PC to post-construction can take place:

1. Smaller-scale sediment traps (generally with drainage areas less than 3 acres) that can be converted to bio-retention, dry swales, or surface sand filter BMPs. See Table 3 for specific conversion guidance.

2. Larger-scale sediment basins with larger drainage areas that can be converted to post-construction stormwater ponds or wetlands. See Table 4.

Figure 2 shows examples of ES&PC practice conversions to post-construction BMPs.

<b>Table 3. Conversion of Smaller-Scale Sediment Traps (generally with drainage areas less than 3 acres) to Bioretention, Dry Swales, or Surface Sand Filter BMPs.</b>	
<b>Topic</b>	<b>Conversion Guidance</b>
Drainage Areas	Drainage areas should be limited by the appropriate post-construction BMP design specifications, even if construction phase drainage areas could be larger. This means that sites may have to be divided into smaller drainage areas with use of multiple ES&PC traps and other ES&PC measures.
Grading to Blend Into Topography	Some temporary ES&PC practices are graded onto slopes, have steep embankments or side slopes, and otherwise don't blend into the surrounding topography. These types of practices are not good candidates to convert to post-construction BMPs, unless regrading is part of the conversion plan. A sounder approach is to design the temporary ES&PC practice so that this type of regrading is not necessary, which may include changing the footprint, grading, slopes, and other features of the ES&PC practice.
Stabilizing the Drainage Area	Make sure the contributing drainage area (CDA) is stabilized prior to conversion. This is a good thing about using ES&PC traps, since they cannot be taken out until their erosion control function is complete. Therefore, the tendency to prematurely install post-construction practices is lessened. The conversion can proceed when site inspectors indicate that the CDA is properly stabilized. In addition to CDA stabilization, other supplemental ES&PC measures may be warranted, such as diverting flow around the practice during the conversion process and using silt fence or matting/sod on side slopes of the practice.
Remove Construction Sediments	All construction sediments should be removed as the first step in the conversion process. This may also involve dewatering the ES&PC practice using an approved dewatering and sediment capture method (e.g., dirt bags, sediment traps).
Excavate Below the ES&PC Practice Bottom Elevation	The bottom of the post-construction practice should be at least one foot lower than the temporary ES&PC bottom elevation. This is so that the bottom of the post-construction BMP will be in undisturbed soils that are not impacted by construction activities. During excavation to the post-construction design elevation, scarify or rip the underlying soil to promote infiltration.
Installing Underdrains	If the post-construction practice design has an underdrain, decide when to install the underdrain. Usually this will be done as part of the conversion (after the construction phase). However, if the underdrain goes through an impounding structure or berm that will stay in place with the post-construction BMP, it may be best to install the underdrain with the initial ES&PC practice, cover it with heavy gage plastic, and then fill on top to reach the desired bottom elevation of the ES&PC practice. This will prevent having to breach the impounding structure or berm to install an underdrain system during the conversion process. At the time of conversion, the overlying soil and plastic can be removed, exposing the underdrain system, at which point the desired soil or filter layers can be placed on top of the underdrain.

**Table 3. Conversion of Smaller-Scale Sediment Traps (generally with drainage areas less than 3 acres) to Bioretention, Dry Swales, or Surface Sand Filter BMPs. (continued)**

Topic	Conversion Guidance
Proceed to Install Post-Construction BMP	Install the practice as per the approved post-construction plans. Some minor grading or adjustments to the footprint may be needed to meet the post-construction design.
Be Aware of Easement and Post-Construction Practice Location	If the post-construction BMP is supposed to be located within a drainage easement or in another specific location (e.g., common area in a subdivision), it is very important to make sure that the final practice is within the specified area in order to avoid costly relocation of the practice.

**Table 4. Conversion of Larger Scale ES&PC Sediment Basins to Post-Construction Stormwater Ponds and Wetlands**

Topic	Conversion Guidance
Timing/Sequencing	Generally, ES&PC basins cannot be converted to a post-construction configuration until the contributing drainage area (CDA) is fully developed and stabilized. However, phasing plans can incorporate additional upgradient ES&PC practices if certain portions of the CDA will be disturbed subsequent to the conversion. This is likely the case with multi-phase development projects, commercial subdivisions, etc.
Sediment Removal	Construction sediment will have to be removed from the basin before conversion to a post-construction BMP. Additional grading may be needed to meet the design standards for the post-construction configuration.
Volume & Design Elevations	Sizing rules are different for ES&PC basins and post-construction BMPs. The ES&PC basin may be larger or smaller than the post-construction practice, so additional grading is likely needed for the conversion. A common problem with conversions is that not all of the construction sediment is removed so that the post-construction elevations are incorrect. Contractors should always check design elevations for the post-construction BMP.
Pond Geometry	Compared to an ES&PC basin, a post-construction practice may have a longer flow path (3:1 recommended), multiple cells, larger surface area, shallower side slopes (e.g., 3:1), deeper or shallower pool depths, safety benches around permanent pools, and other design features. The ES&PC basin should at least consider the overall footprint and general depth of the post-construction pond so that major grading can be avoided in the conversion process.
Pre-Treatment	Most post-construction ponds will incorporate one or more forebays for pretreatment. The forebays can be constructed as part of the ES&PC basin, but it may be preferable to install them as part of the conversion to avoid the cost of cleaning them out, repairing or replacing rock spillways, etc. In either case, the footprint of the forebay should be incorporated into the ES&PC basin footprint.

**Table 4. Conversion of Larger Scale ES&PC Sediment Basins to Post-Construction Stormwater Ponds and Wetlands (continued)**

<b>Topic</b>	<b>Conversion Guidance</b>
Risers & Spillways	The post-construction practice design will adhere to certain safety features and riser designs (likely multi-stage risers to address water quality, channel protection, and flood protection). The designer should consider constructing the post-construction design as part of the ES&PC basin, and then modifying it for the construction phase. For instance, risers can be perforated during construction, and then the perforations plugged as part of the conversion. Certain orifices will likely need to be temporarily plugged during construction. In addition, the spillway and freeboard requirements may be different for the post-construction pond, and relevant design elevations should be used for the temporary ES&PC basin, unless this is specifically addressed otherwise in the conversion plan.
Dewatering Drains	Certain post-construction pond or wetland designs may call for dewatering drains so that pools can be drained to remove sediment or for maintenance. With regard to constructability, it may be best to install drains with the original ES&PC basin, and make sure they do not get clogged during construction.
Rock Weirs, Spillways, Outlet Protection	Rock features may be part of the ES&PC and/or post-construction practice. However, it is likely that they will get filled with sediment during construction, so will have to be replaced or rebuilt as part of the conversion.
Maintenance Access	While temporary ES&PC basins only need to be accessed during the construction phase, post-construction ponds require permanent maintenance access, so this should be planned for during construction.
Landscaping	Most post-construction ponds will have a landscaping plan. Obviously, the landscaping should be installed during the conversion, and not during the active construction phase.

**Figure 2. Typical ES&PC to Post-Construction Conversions as well as Common Pitfall**



**Conversion of a small-scale sediment trap to bioretention. The photos shows adding an underdrain system.**



**Conversion of a sediment basin to a bioretention area. The original riser acts as the overflow structure for the bioretention practice.**



**Post-construction conversion called for the creation of sediment forebay in this larger scale pond.**



**A major issue with conversions is timing. Premature installation of the post-construction practice can result in damage from construction sediments.**

### **Conclusion**

Increasingly, it is important to coordinate ES&PC planning and implementation with post-construction stormwater plans. A coordinated plan will help both phases (construction and post-construction) to proceed in a logical, well thought-out way that avoids costly redesigns and work delays.

The principles of adjusting the limits of disturbance, protecting soil structure associated with post-construction BMPs, diverting construction

runoff around important post-construction areas, developing detailed conversion plans for ES&PC to post-construction BMPs, and coordination and communication among plan reviewers, design professionals, inspectors, and contractors, will help achieve this integration of ES&PC and post-construction stormwater.

# Low Impact Development (LID)



## What is low impact development (LID)?

LID includes a variety of practices that mimic or preserve natural drainage processes to manage stormwater. LID practices typically retain rain water and encourage it to soak into the ground rather than allowing it to run off into ditches and storm drains where it would otherwise contribute to flooding and pollution problems (see [www.epa.gov/nps/lid](http://www.epa.gov/nps/lid)).

*Excerpt from US EPA Low Impact Development (LID) a Literature Review*

## Introduction

Low impact development (LID) is a relatively new concept in stormwater management. LID techniques were pioneered by Prince George's County, Maryland, in the early 1990's, and several projects have been implemented within the state. Some LID principles are now being applied in other parts of the country, however, the use of LID is infrequent and opportunities are often not investigated.

LID is a site design strategy with a goal of maintaining or replicating the pre-development hydrologic regime through the use of design techniques to create a functionally equivalent hydrologic landscape. Hydrologic functions of storage, infiltration, and ground water recharge, as well as the volume and frequency of discharges, are maintained through the use of integrated and distributed micro-scale stormwater retention and

detention areas, reduction of impervious surfaces, and the lengthening of flow paths and runoff time (Coffman, 2000). Other strategies include the preservation/protection of environmentally sensitive site features such as riparian buffers, wetlands, steep slopes, valuable (mature) trees, flood plains, woodlands and highly permeable soils.

LID principles are based on controlling stormwater at the source by the use of micro-scale controls that are distributed throughout the site. This is unlike conventional approaches that typically convey and manage runoff in large facilities located at the base of drainage areas. These multifunctional site designs incorporate alternative stormwater management practices such as functional landscape that act as stormwater facilities, flatter grades, depression storage and open drainage swales. This system of controls can reduce or eliminate the need for a centralized Best Management Practice (BMP) facility for the control of stormwater runoff. Although traditional stormwater control measures have been documented to effectively remove pollutants, the natural hydrology is still negatively affected (inadequate base flow, thermal fluxes or flashy hydrology), which can have detrimental effects on ecosystems, even when water quality is not compromised (Coffman, 2000). LID practices offer an additional benefit in that they can be integrated into the infrastructure and are more cost effective and aesthetically pleasing than traditional, structural stormwater conveyance systems.

Conventional stormwater conveyance systems are designed to collect, convey and discharge runoff as efficiently as possible. The intent is to create a highly efficient drainage system, which will prevent on lot flooding, promote good drainage and quickly convey runoff to a BMP or stream. This runoff control system decreases groundwater recharge, increases runoff volume and changes the timing, frequency and rate of discharge. These changes can cause flooding, water quality degradation, stream erosion and the need to construct end of pipe BMPs. Discharge rates using traditional BMPs may be set only to match the predevelopment peak rate for a specific design year. This approach only controls the rate of runoff allowing significant increases in runoff volume, frequency and duration of runoff from the predevelopment conditions and

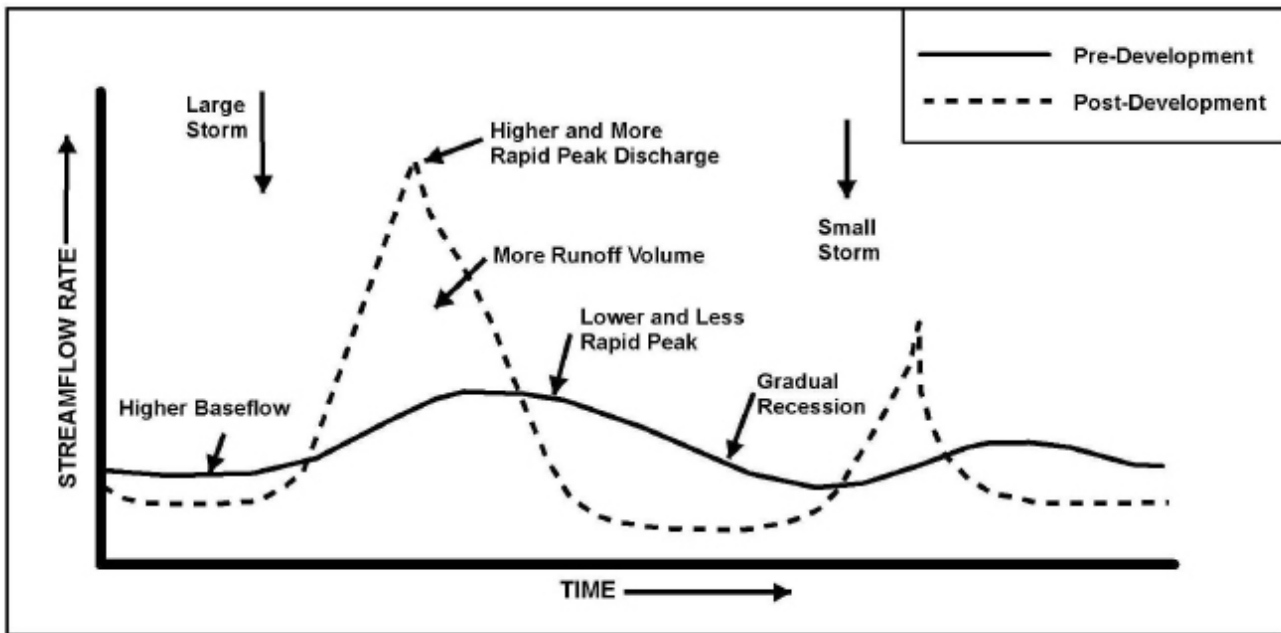

**Figure 1: Changes in Stormwater Hydrology as a Result of Urbanization, Schueler, 1992**

provides the mechanisms for further degradation of receiving waters (Figure 1).

LID has often been compared to other innovative practices, such as Conservation Design, which uses similar approaches in reducing the impacts of development, such as reduction of impervious surfaces and conservation of natural features. Although the goals of Conservation Design protect natural flow paths and existing vegetative features, stormwater is not treated directly at the source. Conservation Design protects large areas adjacent to the development site and stormwater is directed to these common areas.

Although this approach protects trees and does reduce runoff, there is still potentially a significant amount of connected impervious area and centralized stormwater facilities that may contribute to stream degradation through stormwater volume, frequency and thermal impacts. Therefore, the hydrologic and hydraulic impacts of this approach on receiving waters may still be significant, although the volume and flows will be less than without the conservation design. The stormwater control measures used in Conservation Design are off-site and therefore not the individual property owner's responsibility. However, maintenance is generally provided by the homeowners association and financed through association fees.

### Benefits and Limitations

The use of LID practices offers both economic and environmental benefits. LID measures result in less disturbance of the development area, conservation of natural features and can be less cost intensive than traditional stormwater control mechanisms. Cost savings for control mechanisms are not only for construction, but also for long-term maintenance and life cycle cost considerations. For example, an alternative LID stormwater control design for a new 270 unit apartment complex in Aberdeen, NC will save the developer approximately 72% or \$175,000 of the stormwater construction costs. On this project, almost all of the subsurface collection systems associated with curb and gutter projects have been eliminated. Strategically located bioretention areas, compact weir outfalls, depressions, grass channels, wetland swales and specially designed storm water basins are some of the LID techniques used. These design features allow for longer flow paths, reduce the amount of polluted runoff and filter pollutants from stormwater runoff (Blue Land, Water and Infrastructure, 2000).

Today many states are facing the issue of urban sprawl, a form of development that consumes green space, promotes auto dependency and widens urban fringes, which puts pressure on environmentally sensitive areas. "Smart growth" strategies are designed to reconfigure development in a more eco-efficient and community oriented style. LID addresses many of the envi-

ronmental practices that are essential to smart growth strategies including the conservation of open green space. LID does not address the subject of availability of public transportation.

LID provides many opportunities to retrofit existing highly urbanized areas with pollution controls, as well as address environmental issues in newly developed areas. LID techniques such as rooftop retention, permeable pavements, bioretention and disconnecting rooftop rain gutter spouts are valuable tools that can be used in urban areas. For example, stormwater flows can easily be directed into rain barrels, cisterns or across vegetated areas in high-density urban areas. Further opportunities exist to implement bioretention systems in parking lots with little or no reduction in parking space. The use of vegetated rooftops and permeable pavements are 2 ways to reduce impervious surfaces in highly urbanized areas.

LID techniques can be applied to a range of lot sizes. The use of LID, however, may necessitate the use of structural BMPs in conjunction with LID techniques in order to achieve watershed objectives. The appropriateness of LID practices is dependent on site conditions, and is not based strictly on spatial limitations. Evaluation of soil permeability, slope and water table depth must be considered in order to effectively use LID practices. Another obstacle is that many communities have development rules that may restrict innovative practices that would reduce impervious cover. These “rules” refer to a mix of subdivision codes, zoning regulations, parking and street standards and other local ordinances that determine how development happens (Center for Watershed Protection, 1998). These rules are responsible for wide streets, expansive parking lots and large-lot subdivisions that reduce open space and natural features. These obstacles are often difficult to overcome.

Additionally, community perception of LID may prevent its implementation. Many homeowners want large-lots and wide streets and view reduction of these features as undesirable and even unsafe. Furthermore, many people believe that without conventional controls, such as curbs and gutters and end of pipe BMPs, they will be required to contend with basement flooding and subsurface structural damage.

## **Low Impact Development Practices**

LID measures provide a means to address both pollutant removal and the protection of pre-development hydrological functions. Some basic LID principles include conservation of natural features, minimization of impervious surfaces, hydraulic disconnects, disbursement of runoff and phytoremediation. LID practices such as bioretention facilities or rain gardens, grass swales and channels, vegetated rooftops, rain barrels, cisterns, vegetated filter strips and permeable pavements perform both runoff volume reduction and pollutant filtering functions.

### **Bioretention**

Bioretention systems are designed based on soil types, site conditions and land uses. A bioretention area can be composed of a mix of functional components with each performing different functions in the removal of pollutants and attenuation of stormwater runoff.

### **Grass Swales**

Grass swales or channels are adaptable to a variety of site conditions, are flexible in design and layout, and are relatively inexpensive (USDOT, 1996). Generally open channel systems are most appropriate for smaller drainage areas with mildly sloping topography (Center for Watershed Protection, 1998). Their application is primarily along residential streets and highways. They function as a mechanism to reduce runoff velocity and as filtration/infiltration devices. Sedimentation is the primary pollutant removal mechanism, with additional secondary mechanisms of infiltration and absorption. In general grass channels are most effective when the flow depth is minimized and detention time is maximized. The stability of the channel or overland flow is dependant on the erodibility of the soils in which the channel is constructed (USDOT, 1996). Decreasing the slope or providing dense cover will aid in both stability and pollutant removal effectiveness.

### **Vegetated Roof Covers**

Vegetative roof covers or green roofs are an effective means of reducing urban stormwater runoff by reducing the percentage of impervious surfaces in urban areas. They are especially effective in older urban areas with chronic Combined Sewer Overflow (CSO) problems, due to the high level of imperviousness. The green roof



is a multilayered constructed material consisting of a vegetative layer, media, a geotextile layer and a synthetic drain layer. Vegetated roof covers in urban areas offer a variety of benefits, such as extending the life of roofs, reducing energy costs and conserving valuable land that would otherwise be required for stormwater runoff controls. Green roofs have been used extensively in Europe to accomplish these objectives. Many opportunities are available to apply this LID measure in older U.S. cities with stormwater infrastructures that have reached their capacities.

### **Permeable Pavements**

The use of permeable pavements is an effective means of reducing the percent of imperviousness in a drainage basin. More than thirty different studies have documented that stream, lake and wetland quality is reduced sharply when impervious cover in an upstream watershed is greater than 10%.

Porous pavements are best suited for low traffic areas, such as parking lots and sidewalks. The most successful installations of alternative pavements are found in coastal areas with sandy soils and flatter slopes (Center for Watershed Protection, 1998).

Permeable pavements allow stormwater to infiltrate into underlying soils promoting pollutant treatment and recharge, as opposed to produc-

ing large volumes of rainfall runoff requiring conveyance and treatment. Costs for paving blocks and stones range from \$2 to \$4, whereas asphalt costs \$0.50 to \$1 (Center for Watershed Protection, 1998).

### **Other LID Strategies**

Another strategy to minimize the impacts of development is the implementation of rain gutter disconnects. This practice involves redirecting rooftop runoff conveyed in rain gutters out of storm sewers, and into grass swales, bioretention systems and other functional landscape devices. Redirecting runoff from rooftops into functional landscape areas can significantly reduce runoff flow to surface waters and reduce the number of CSO events in urban areas. As long as the stormwater is transported well away from foundations, concerns of structural damage and basement flooding can be alleviated. As an alternative to redirection of stormwater to functional landscape, rain gutter flows can be directed into rain barrels or cisterns for later use in irrigating lawns and gardens. Disconnections of rain gutters can effectively be implemented on existing properties with little change to present site designs.

**For the complete literature review visit:**<http://water.epa.gov/polwaste/green/lidlit.cfm>

#### **Links for additional information:**

**Center for Watershed Protection** -<http://www.cwp.org/>

**City of Atlanta** - <http://www.atlantawatershed.org/greeninfrastructure/>

**City of Roswell** - <http://www.roswellgov.com/index.aspx?NID=1586>

**Georgia Department of Natural Resources - Coastal Resources Division**

<http://coastalgadnr.org/cm/green/guide>

<http://coastalgadnr.org/cm/green/demo>

**Georgia Institute of Technology, Office of Environmental Stewardship**

<http://www.stewardship.gatech.edu/stormwater.php>

**US Environmental Protection Agency** - <http://water.epa.gov/polwaste/green/>



# CHAPTER 4

## LOCAL PROGRAMS: PRINCIPLES AND PROCESSES

The Erosion and Sedimentation Act of 1975 states that the governing authority of each county and municipality shall adopt a comprehensive ordinance establishing procedures governing land-disturbing activities conducted within their respective boundaries. The emphasis of the law is truly on implementation of *local* erosion and sediment control programs.

If counties and municipalities have failed to have in effect an ordinance conforming to the provisions of the law, then the State Board of Natural Resources will adopt appropriate rules and regulations governing activities within those areas.

### PRINCIPLES

For any erosion and sediment control *program* to become effective, there are certain principles that should be applied for maximum effectiveness.

1. Erosion and sediment control should become a stated policy of all concerned, including public and private agencies operating in or having jurisdiction within the boundaries of the unit of government.
2. The appropriate GSWCC certification of persons involved in land development design, review, permitting, construction, monitoring, or inspection of any land-disturbing activity.
3. Competent technical personnel knowledgeable in local soil and climatic conditions, workable procedures, and inspections are necessary for successful erosion and sediment control.
4. To be effective, provisions for erosion and sediment control must be made in the planning stage. Practical combinations of the basic design principles contained in Chapter 2 should be skillfully planned and applied in a timely manner.

5. Research observations and evaluations should be conducted to provide needed information for improvement of the erosion and sediment control program. The Soil and Water Conservation Districts and/or the GSWCC are required by the Act to semi-annually review the erosion and sediment control programs for effectiveness of the cities and counties that have been certified as a Local Issuing Authority (LIA).

### PROCESSES

An erosion and sediment control program may be subdivided into four basic processes:

- a. ordinance development and implementation
- b. plan preparation and review
- c. inspection and enforcement
- d. information, education and training

### ORDINANCE DEVELOPMENT AND IMPLEMENTATION

Local officials have a working knowledge of local conditions and problems. It is they who can best implement ordinances that take local needs into account.

In the past, the cost of correcting expensive sediment damages has often been the responsibility of local units of government. Therefore, it is advisable that local governments have direct control over the enforcement of laws pertaining to erosion. The LIA may require the permit applicant to post a bond of up to \$3,000.00 per acre of the proposed land-disturbing activity, prior to issuing the permit. If the applicant fails to comply with the conditions of the permit after issuance, the LIA may call the bond and use the proceeds to hire a contractor to stabilize the project site and bring it into compliance.

Although the direct responsibility for drafting ordinances falls on local officials, citizen participation should be encouraged to insure that the final product will reflect their needs and wishes.

A model ordinance has been developed by the GSWCC and the GA EPD for use by officials in municipalities and counties. The model is intended primarily to provide guidelines for control of *urban* soil erosion and sediment pollution. It is designed to meet state requirements for establishing programs as required in Act 599, as well as compliance with the NPDES Permits. A copy of the model is con-

tained in Appendix D of this Manual, and can be found on the GSWCC and GA EPD websites.

Preceding the body of the model ordinance is a brief explanation of the contents. This explanation is intended to clarify certain sections or phrases contained in the model. Opinions expressed therein are not necessarily requirements to be fulfilled. Local authorities may wish to develop individual ordinances from the wealth of comprehensive material available for this, or they may utilize another of the models available. Regardless of the method used, the contents of the model ordinance must be incorporated into the ordinance adopted by the LIA. However, the LIA's ordinance may exceed the standards, requirements and provisions of the Act and NPDES except for those involving monitoring, reporting, inspections, design standards, turbidity standards, education and training, and project size thresholds with regard to education and training requirements. A review of the final draft by the county or city attorney should be mandatory.

An LIA must review, revise, or amend its ordinances within twelve months of any amendment to the E&SC Act.

Any land-disturbing activities by an LIA shall be subject to the same requirements of the ordinances of the LIA as are applied to private persons, and the GA EPD shall enforce such requirements upon the LIA.

The adoption of an ordinance should be considered as only the first step toward a sound soil erosion and sedimentation control program. It is essential that sufficient lead time be provided for education of the public and technical training of persons directly involved in its full implementation.

## **PLAN PREPARATION AND REVIEW PROCESS**

All parties involved in the plan development and review process must realize without exception that there is *more than one approach* to minimizing erosion and sedimentation damages. Flexibility without compromising the primary objective must be encouraged to arrive at a common solution to erosion and sediment control problems on any given site. All available resources should be explored. Local officials should plan to provide assistance to the developer and his consulting planners and engineers prior to

plan submission before plan processing can be effective. Assistance from federal and state agencies having expertise in the field of soil and water conservation should be provided to the developer and his consultant. Developers may benefit by entering into an agreement for assistance through their Soil and Water Conservation District. Technical expertise can then be provided by federal and state agencies.

The erosion and sediment control plan should be submitted as early in the planning stage as possible. The plan itself should embrace all aspects of the requirements of the basic design principles as specified in Chapter 2 of this Manual. In addition, practical combinations of vegetative and structural conservation practices should be designed in accordance with the minimum requirements of the Standards and Specifications contained in Chapter 6.

It is recommended that the plan review process be broken down into the preliminary planning phase and the final design phase to reduce costly engineering fees. Such fees are normally considerably higher than preliminary planning fees. Costs for changes to engineering drawings and specifications can be prohibitive. An early, or first phase, submission of erosion and sediment control plans will promote general agreement and cooperation and provide for changes with minimum delay to the development process.

The responsibility for plan reviews has been delegated by Act 599 to the Soil and Water Conservation Districts; however, this does not relieve the county or municipality from a responsibility to assure that plans conform to other local regulations and ordinances. When an LIA has entered into a memorandum of agreement with the district to review erosion and sediment control plans, the LIA has forty-five days to approve or deny the plans. The LIA must state the reasons for denial, and a resubmittal of revised plans must be approved or denied within thirty-five days. For each resubmittal the thirty-five day period restarts.

## **PLAN PROCESSING**

The following is a recommended procedure for preparation and processing of an erosion and sediment control plan:

1. The owner, developer, or the authorized

agent for either the owner or the developer, prepares the erosion and sediment control plan. The plan is prepared in accordance with the minimum requirements and recommendations contained in the Manual for Erosion and Sediment Control. (The Manual should be incorporated by reference in the local erosion and sediment control ordinance.) Plans should be prepared only after consultation with the LIA.

2. The owner, developer, or the authorized agent for the owner or developer, submits the plans to the local permit-issuing authority after completing an application for a permit. (Local officials should determine the number of copies of plans and applications to be submitted by the owner, etc. It is suggested that a minimum of three copies of the plan be submitted.) If an application form has not been developed by the local unit of government, a letter of transmittal containing the following information should accompany the plans.
  - a. The name, address and phone number of the applicant.
  - b. The name, address and phone number of the land owner of record.
  - c. The name, address and phone number of the person responsible for carrying out the plan.
  - d. The name, address and phone number of the person preparing the plan.
  - e. The location of the activity including land lot and tax map page numbers.
  - f. Any other information as determined by the local unit of government.

The local unit of government may require that a preliminary erosion and sediment control plan be submitted along with a preliminary site plan. The preliminary erosion control plan should not be cluttered with detailed erosion and sediment measures but should include the following information:

- a. Soil boundaries of all major soil series.
- b. Approximate limits of grading.
- c. Tentative measures for sediment and erosion control.

- d. Phasing of development to minimize area and duration of exposure of soils to erosive elements.

It is suggested that the issuing authority of the county or municipality delegate the authority for receiving applications and processing permits to the county engineer, director of public works or other qualified individuals knowledgeable in the processing of site development plans. If in the ordinance the responsibilities of the issuing authority are delegated to the constitutional or statutory local planning and zoning commission, then it is suggested that the plans and applications be processed by the director of the planning and zoning commission.

3. Two copies of the erosion and sediment control plan shall be forwarded as soon as possible to the local Soil and Water Conservation District, or its delegated authority, for review. In determining the adequacy of the plan, the district officials (Supervisors) will be guided by the requirements and recommendations contained in the local manual. District Supervisors may request the assistance from the erosion and sediment control specialist with the State Soil and Water Conservation Commission, specialists from the District or technical personnel of the Natural Resources Conservation Service. The District Supervisor, after consultation with the district board, will forward the plans and recommendations to the permit-issuing authority of the municipality or county. These recommendations should include measures necessary to meet requirements and recommendations outlined in the Manual. A copy of the recommendations of the district's technical advisor may be forwarded to the permit-issuing authority.
4. The permit-issuing authority of the local unit of government, after consultation with the governing board, and after a thorough review of the plan for compliance with other resolutions or ordinances, rules and regulations, should then issue or deny a permit. If a plan is not approved, the modifications necessary to permit approval of the plan should be specified in writing.

### **Plan Revisions**

An approved plan may be revised if inspec-

tions reveal that the erosion and sediment control plan is inadequate in accomplishing the objectives of the law. If so, modifications to correct the deficiencies must have the concurrence of the plan-reviewing authority.

Revision may also be required when the person responsible for carrying out the approved plan finds that, because of changed conditions or other reasons, the approved plan cannot be effectively carried out. Minor changes made in the field must be noted on the approved set of plans on site and the site must match the approved plans. Any changes made to the approved plans that have a significant effect on BMP's with a hydraulic component must be certified by the design professional, and resubmitted to the LIA/District for approval.

### **Checklist of Plan Preparation and Review**

Some of the issues that the plan preparers and plan reviewers need to consider are:

1. Does the proposed plan contain information reflecting actual existing site conditions?
2. Will the roadways, buildings and other permanent features conform to the natural topography of the site?
3. Will the limitations of soils and steep slopes be overcome by sound engineering practices?
4. Will clearing be limited to only those areas of the site to be developed?
5. Will natural vegetation be retained and provisions made for protection of existing vegetation and for supplemental planting?
6. Will major land clearing and grading operations be scheduled during seasons of low potential sediment runoff?
7. Will the time of exposure of land clearing and grading be kept to a minimum?
8. Will permanent structures, temporary or permanent vegetation or mulch be scheduled for installation as quickly as possible after the land is disturbed?
9. Will all storm water management facilities, temporary or permanent, be designed to safely convey water to a stable outlet?

10. Will sediment basins, sediment barriers, and related devices be planned to filter or trap sediment on the site? Can these structures be easily maintained?
11. Will proposed vegetation be suitable for the intended use?
12. Do potential pollution hazards, including off-site sediment, noise and dust exist?
13. Are proposed permanent facilities subjected to flood or sediment damages?
14. Do subsurface conditions exist that could lead to pollution of ground water or aquifer recharge areas?
15. Is the construction schedule adequate?
16. Will erosion and sediment control measures be in place before extensive grading and clearing begins?
17. Have areas been designated for storage of salvaged topsoil?
18. Can *all* soil erosion and sediment control measures be adequately maintained?

For the plan to meet all requirements of the Act and the NPDES General Permits, the GSWCC and the GA EPD have created plan review checklists. There is a separate checklist and guidance document for each of the permits; Stand Alone Construction Projects, Infrastructure Construction Projects, and Common Developments. The appropriate checklist must be completed and submitted with the ES&PC Plan for the plan to be reviewed. All checklists and guidance documents can be found on the GSWCC and the GA EPD websites.

### **INSPECTION AND ENFORCEMENT PROCESS OF LOCAL ISSUING AUTHORITY**

With regard to the inspection and enforcement process, it should be noted that it is not the purpose of this Manual to support or promulgate specific courses of action by local authorities in these areas. Except as provided by Act 599, the local authorities are expected to exercise autonomy in determining the extent of any enforcement and inspection processes. The information provided here, as elsewhere in the Manual, is only

in keeping with the responsibility of a publication such as this to offer, for informational purposes, the alternatives available and in no way represents official opinion or recommendation.

These responsibilities begin after the issuance of a permit for a land-disturbing activity. A crucial element in any sediment and erosion control program is adequate field inspection for evaluating compliance to the approved erosion and sediment control plan. These inspections *might* be effectively incorporated in other existing local inspection programs.

Although Act 599 specifies that the actual responsibility for inspection is that of the governing authority, on-site inspection may be assigned to a building inspector or another person employed by the Local Issuing Authority. The inspector, whether a soils engineer, civil engineer, soil conservationist, or technician, should have some knowledge in the field of soil and water conservation.

To assure that the enforcing agency and the permit applicant are in agreement about the control procedures to be followed, a pre-construction conference would be desirable. This conference should be held prior to beginning the land disturbing activity. All facets of the proposed work should be discussed at this meeting and anticipated problems reviewed. The need for installing initial sediment storage requirements and perimeter control BMPs prior to actual clearing and grading operations should be emphasized. The individual responsible for carrying out the plan should also be informed of local inspection policies and schedules.

The institution of both scheduled and random inspections would be appropriate. The former would be a routine inspection related directly to construction operations and carried out on a rigid schedule. Random or impromptu site inspections would assure continuing compliance and the proper maintenance of erosion and sediment control measures. The LIA should inspect each project site for compliance at least once every seven calendar days and within 24 hours of each significant rainfall event.

The implementation of a record keeping system would insure coordination of the inspection process with other departments and local agencies. The record system should contain a detailed filing system for all land-disturbing activities. This file should contain a record including the date of each inspec-

tion, the date land-disturbing activities commenced, and pertinent comments concerning compliance or noncompliance with the erosion and sediment control plan. In cases of noncompliance, the report should contain statements of the conservation measures needed for compliance and the recommended time in which such measures should be installed. Inspection reports should be immediately forwarded to the Local Issuing Authority.

In the event that inspections indicate a violation exists, some type of system for notifying the violator would probably be necessary. An effective system often utilized by authorities involves a written "Notice to Comply." If proper action is not taken within five days, the Local Issuing Authority shall issue a stop work order requiring all land-disturbing activities be stopped until corrective action and mitigation have been taken.

The county engineer, building inspector, etc., would represent the issuing authority in handling complaints about missing or ineffective erosion control measures. When it is determined that ineffective erosion control measures are being followed, but those measures comply with the approved erosion control plan, the city engineer, building inspector, etc., should notify the local Soil and Water Conservation District.

### **Checklist of Site Inspection**

The process of inspecting construction operations requires knowledge of the basic principles and control measures in Chapter 2. A thorough understanding of the erosion and sediment control plan is absolutely essential. The following checklist is supplied to assist the inspector in fulfilling his responsibilities.

1. Are all erosion and sediment control measures in place, adequate and properly constructed?
2. Have clearing operations been confined within the limits as shown on the plan?
3. Is vegetation outside of the clearing area protected? Supplemented?
4. Is sediment being transported from the site onto public right-of-way by vehicular traffic?
5. Are erosion problems present in the vicinity of temporary or permanent storm water management facilities?

6. Are sediment basins, sediment barriers and related devices effective in retaining sediment on the site?
7. Is appropriate vegetation being established as needed on the specified area?
8. Is work progressing in accordance with the proposed schedule?
9. Is the contractor following the plan and construction sequence?
10. Have temporary stream channel crossings been installed and maintained?
11. Are embankment slopes and permanent structures installed in areas subject to flood or sediment damage?
12. Has topsoil been salvaged and stored in the area designated by the plans?
13. Do severe fire hazards exist that would result in brush or grass fires?
14. Are all erosion and sediment control measures properly maintained?
15. Is excessive sediment leaving the site for any reason?
16. Have all buffers adjacent to “state waters” been honored?

To comply with the inspection and monitoring requirements of the NPDES permits sample inspection forms can be found on the GA EPD and the GSWCC websites. The GSWCC NPDES General Permits - Stormwater Discharges from Construction Activities Forms include the following forms:

1. Daily Inspections
2. Daily Rainfall Log
3. Site Inspection Report
4. Inspection Summary
5. Weekly Inspection Report
6. Monthly Inspection Report
7. Storm Water Discharge Data
8. Storm Water Monitoring Records



## **Enforcement, Penalties, and Incentives**

For each proposed land-disturbing activity, a decision should be made on precautions insuring that conservation measures are installed. These precautions may include a cash bond, cash escrow, letter of credit, or any combination thereof. The purpose is to insure that the planned conservation measures are installed at the applicant's expense if he fails to do it within the specified time. If a cash incentive is used, it should be required prior to commencing the land disturbing activity.

In the event that the requirements of the erosion and sediment control plans are not being fulfilled, one alternative the local units of government may consider is withholding future permits such as additional grading, building, etc., involving the particular land-disturbing site.

Local authorities may consider assessing fees for erosion and sediment control plan processing. The cost of inspection services could be recouped, if desired, by levying permit fees.

## **INFORMATION, EDUCATION AND TRAINING PROCESS**

One of the most important processes in *any* erosion and sediment control program is an effective information and education effort. A local program *must* have the acceptance and the support of those persons most affected... the developers, engineers, planners, and architects, as well as the general public. Without their support, effective sediment and erosion control *will not* take place. It is very important that the "conservation pays" ethic be adopted by these groups.

Each municipality and county must formulate plans for an information/education program. Consideration should be given to:

1. Informing the developer and others affected by the requirements of the local program and of the assistance which will be made available to them.
2. Training seminars, conferences and educational material for the developer, his consultants, contractors and other support personnel of the developers.
3. Training seminars for the local government personnel authorized to perform the functions of inspections and enforcement and

administrative duties within the local erosion and sediment control program.

An initial training program for new employees, or personnel such as building inspectors who will have an added duty of inspection for erosion control, is mandatory. Annual refresher courses or training programs should be planned.

Assistance in planning and conducting local training programs may be obtained through the Soil and Water Conservation Districts.

# CHAPTER 5

## SOURCES OF ASSISTANCE AND RESOURCE INFORMATION

### ASSISTANCE

Act 599 emphasizes *local* erosion and sedimentation control programs. Policies governing permit issuance, inspection and enforcement may therefore vary between each municipality or county. The individual contemplating a land-disturbing activity should contact the governing authority of the county or municipality having jurisdiction over the proposed land change. Contacts should be made during the earliest phases of planning to avoid costly changes or delays.

Act 599 specifies that the plan review process will be accomplished by the *local* Soil and Water Conservation District or its delegated authority. To insure that the erosion and sediment control plan will conform to local requirements, the developers should contact a District Supervisor in the county in which the land-disturbing activity will take place *early* in the planning stage.

### RESOURCE INFORMATION

A wealth of resource data exists in various agencies which will assist in planning for land-disturbing activities and in the preparation of erosion and sediment control plans. The agencies and websites listed below will provide relevant information. The following pages also provide websites for the agencies' local offices throughout the state. Please visit their websites for the most up-to-date contact information.

#### Soils Information

USDA Natural Resources Conservation Service (NRCS), Soils  
<http://www.nrcs.usda.gov/wps/portal/nrcs/site/soils/home/>

USDA NRCS, Georgia  
<http://www.nrcs.usda.gov/wps/portal/nrcs/site/ga/home/>

Georgia Soil and Water Conservation Commission (GSWCC)  
<https://gaswcc.georgia.gov/>

#### Topographic and Geologic Information

United States Geological Survey (USGS)  
<http://www.usgs.gov/>

USGS South Atlantic Water Science Center, Georgia  
<http://ga.water.usgs.gov/>

#### Non-Point Source Pollution Control

Georgia Department of Natural Resources (DNR)  
Environmental Protection Division (EPD)  
Watershed Protection Branch (WPB)  
Non-Point Source Pollution Control Program  
<http://epd.georgia.gov/watershed-protection-branch>

#### Fisheries Management

Georgia DNR  
Wildlife Resources Division  
Fisheries Management Section  
<http://www.georgiawildlife.com/fishing/fisheries-management>

#### Stream Flow Information

USGS National Streamflow Information Program  
<http://water.usgs.gov/nsip/>

#### Flood Hazard, Wetlands and 404 Permit Information

U.S. Army Corps of Engineers (USACE)  
<http://www.usace.army.mil/>

USACE, Savannah District  
<http://www.sas.usace.army.mil/Missions/Regulatory/Permitting.aspx>

Georgia DNR, EPD, WPB  
Floodplain Management  
<http://epd.georgia.gov/floodplain-management>

USDA NRCS  
<http://www.nrcs.usda.gov/wps/portal/nrcs/main/national/programs/landscape/wfpo/>

<http://www.nrcs.usda.gov/wps/portal/nrcs/main/national/water/wetlands/>

#### Agriculture Information

USDA NRCS  
<http://www.nrcs.usda.gov/wps/portal/nrcs/site/national/home/>

GSWCC  
<https://gaswcc.georgia.gov/>

#### Forestry Information

Georgia Forestry Commission  
<http://www.gatrees.org/>

## Georgia Soil and Water Conservation Commission Conservation Regions

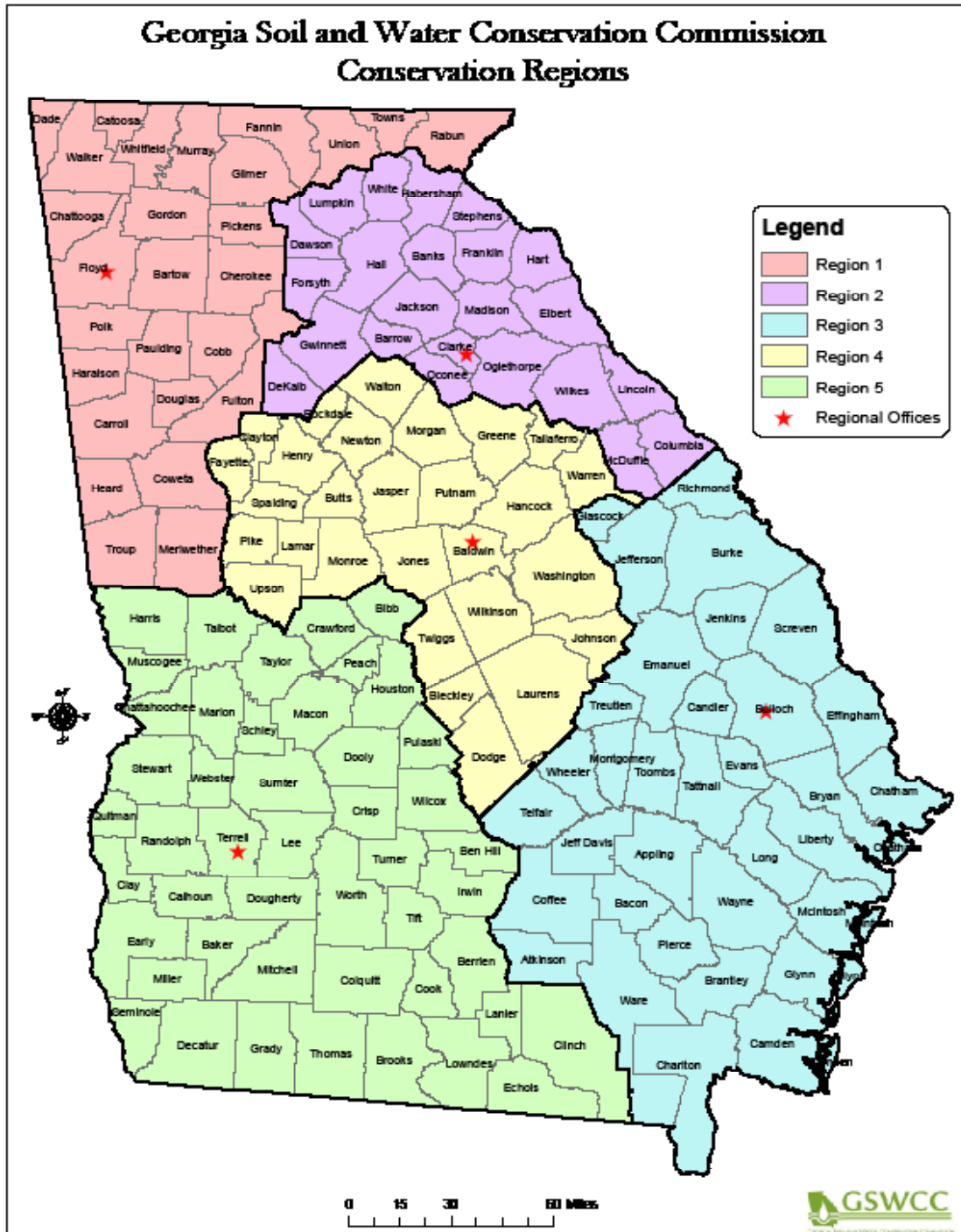

<http://gaswcc.georgia.gov/soil-water-conservation-districts>

Region I  
Calhoun, GA  
<http://gaswcc.georgia.gov/region-i>

Region II  
Athens, GA  
<https://gaswcc.georgia.gov/region-ii-conservation-district>

Region III  
Statesboro, GA  
<https://gaswcc.georgia.gov/region-iii>

Region IV  
Milledgeville, GA  
<http://gaswcc.georgia.gov/region-iv>

Region V  
Dawson, GA  
<http://gaswcc.georgia.gov/region-v>

# Georgia Soil and Water Conservation Commission

## Conservation Districts with their corresponding Regions

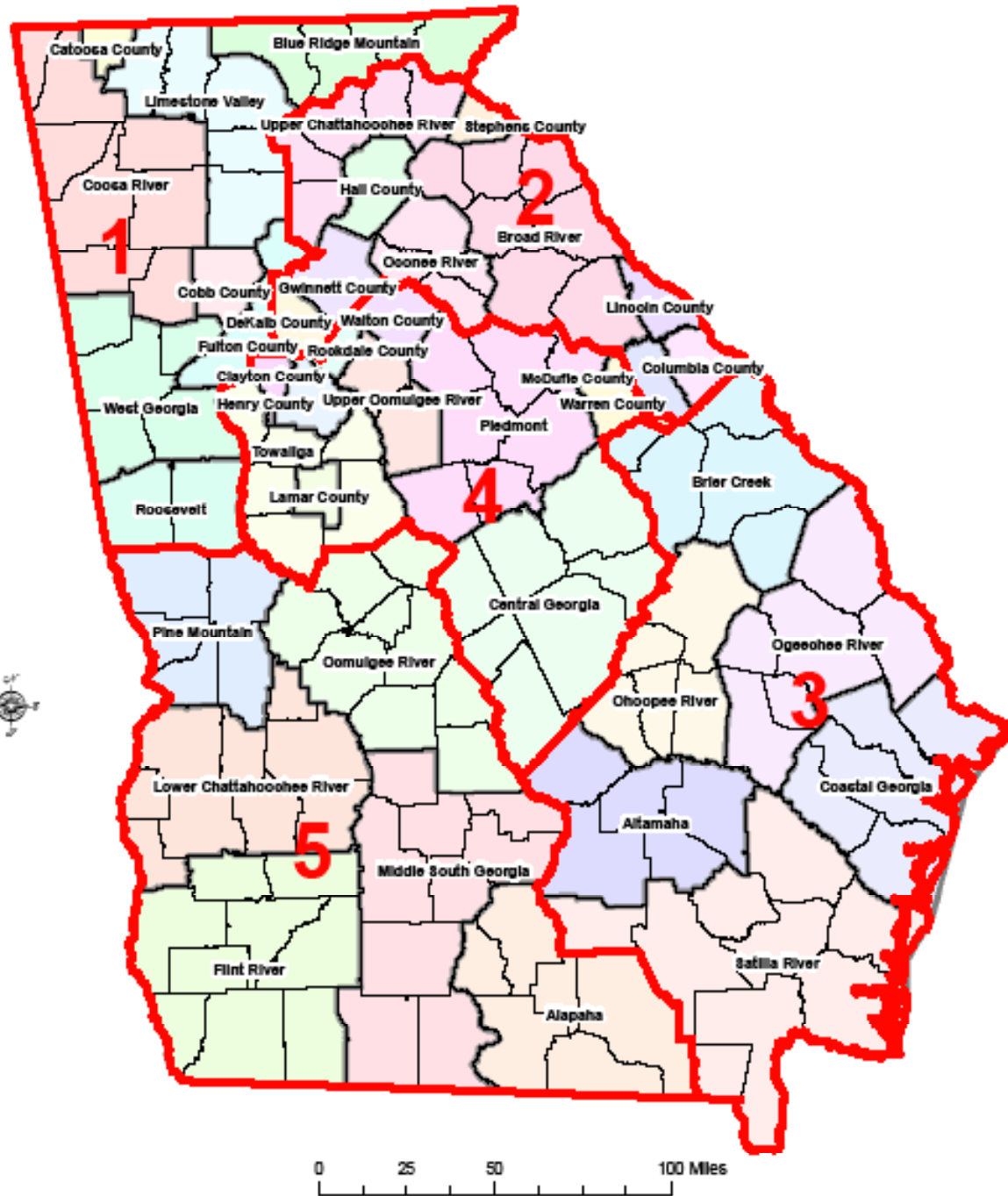

Legend					
Conservation Regions	Broad River	DeKalb County	Lincoln County	Piedmont	Upper Ocmulgee River
County_LayerBasin_Clip	Catoosa County	Flint River	Lower Chattahoochee River	Pine Mountain	Walton County
<b>SWCC Districts</b>	Central Georgia	Fulton County	McDuffie County	Rockdale County	Warren County
<all other values>	Clayton County	Gwinnett County	Middle South Georgia	Roosevelt	West Georgia
Alapaha	Coastal Georgia	Hall County	Ocmulgee River	Satilla River	
Allamaha	Cobb County	Henry County	Oconee River	Stephens County	
Blue Ridge Mountain	Columbia County	Lamar County	Ogeechee River	Towalliga	
Brier Creek	Coosa River	Limestone Valley	Ochopee River	Upper Chattahoochee River	



# Georgia Department of Natural Resources Environmental Protection Division

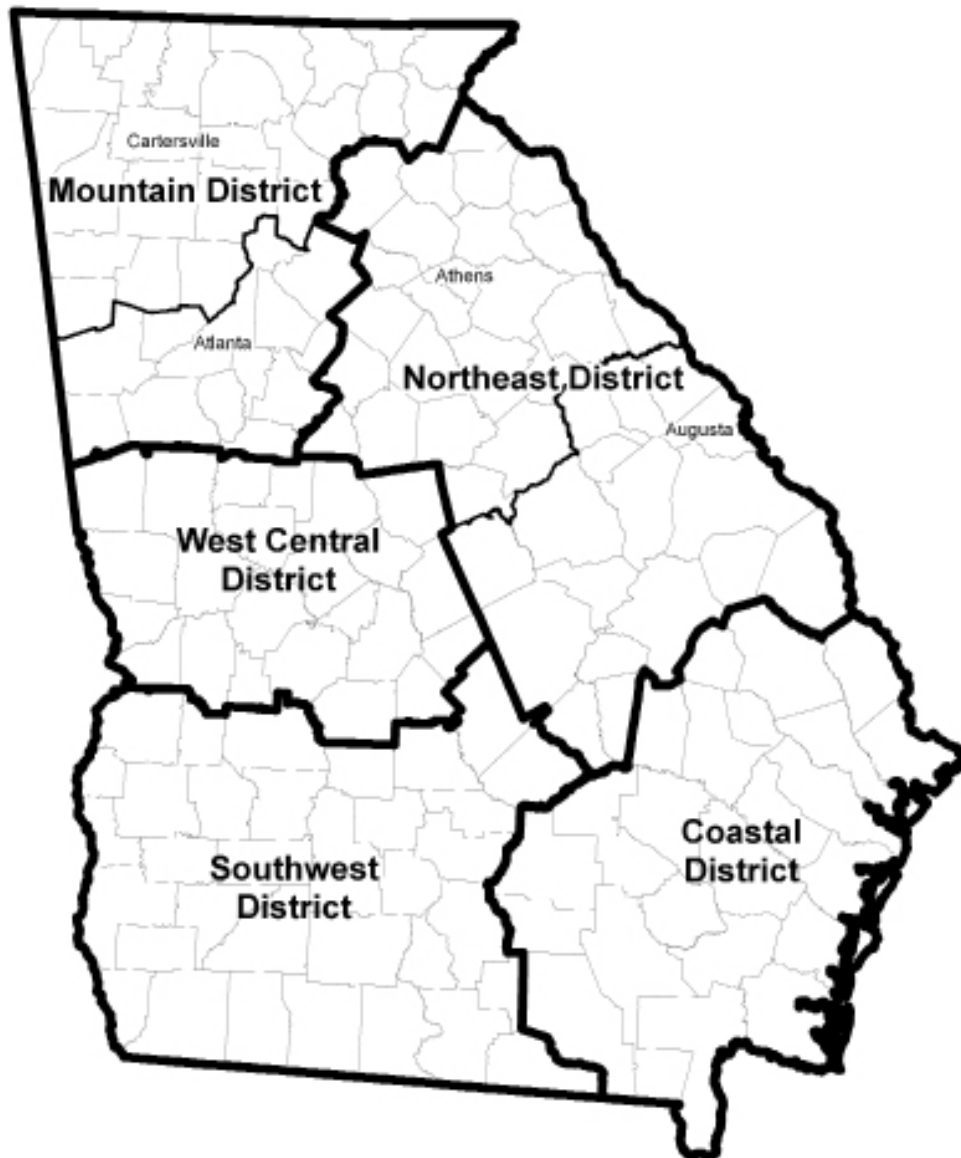

<http://epd.georgia.gov/district-office-locations>

Coastal District  
Brunswick, GA

East Central District  
Augusta, GA

Mountain District  
Atlanta, GA  
Cartersville, GA

Northeast District  
Athens, GA

Southwest District  
Albany, GA

West Central District  
Macon, GA

# Georgia Department of Natural Resources Wildlife Resource Division Fisheries Management Section

<http://www.georgiawildlife.com/fishing/fisheries-management>

## Region 1

Gainesville, GA

<http://www.georgiawildlife.com/node/792>

## Region 2

Fort Valley, GA

<http://www.georgiawildlife.com/Contact/FisheriesRegion2>

## Region 3

Albany, GA

<http://www.georgiawildlife.com/Contact/FisheriesRegion3>

## Region 4

Waycross, GA

<http://www.georgiawildlife.com/Contact/FisheriesRegion4>

## Region 5

Richmond Hill, GA

<http://www.georgiawildlife.com/Contact/FisheriesRegion5>

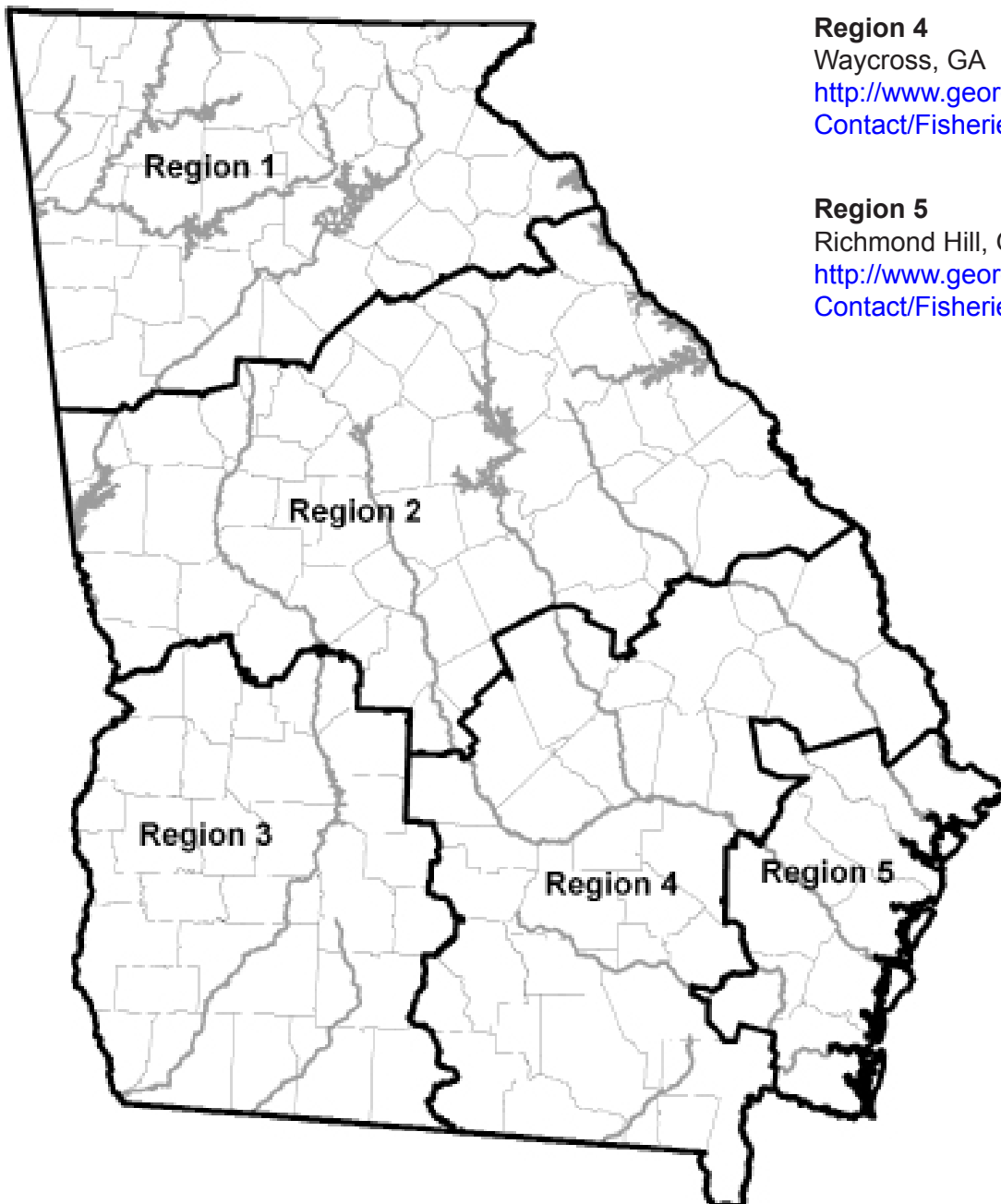

[www.georgiawildlife.com](http://www.georgiawildlife.com)

# Georgia Department of Transportation District Offices

<http://www.dot.ga.gov/AboutGDOT/Districts>

**District One**  
Gainesville, GA

**District Two**  
Tennille, GA

**District Three**  
Thomaston, GA

**District Four**  
Tifton, GA

**District Five**  
Jesup, GA

**District Six**  
Cartersville, GA

**District Seven**  
Chamblee, GA

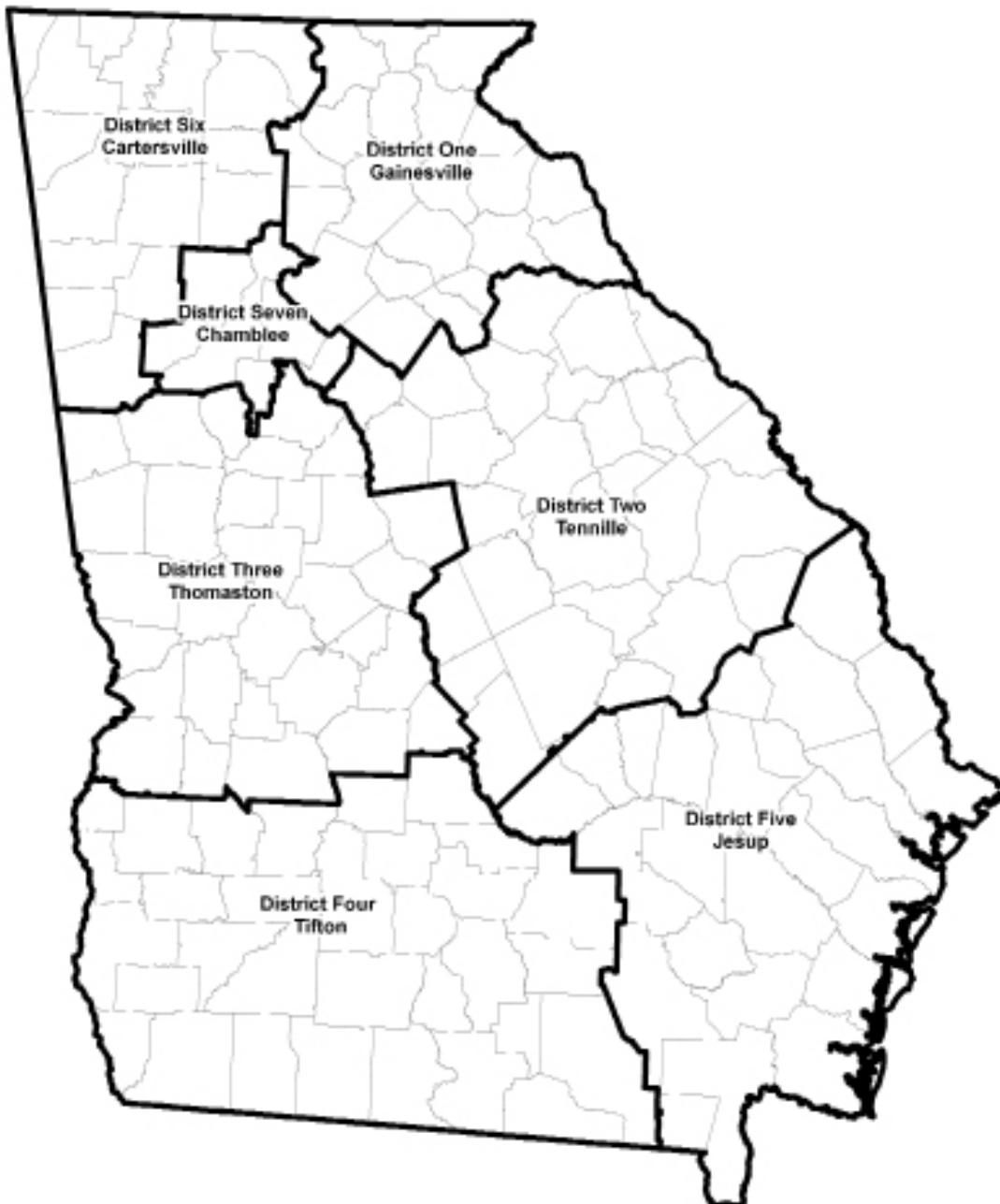

[www.dot.ga.gov](http://www.dot.ga.gov)

# Georgia Forestry Commission Water Quality Districts

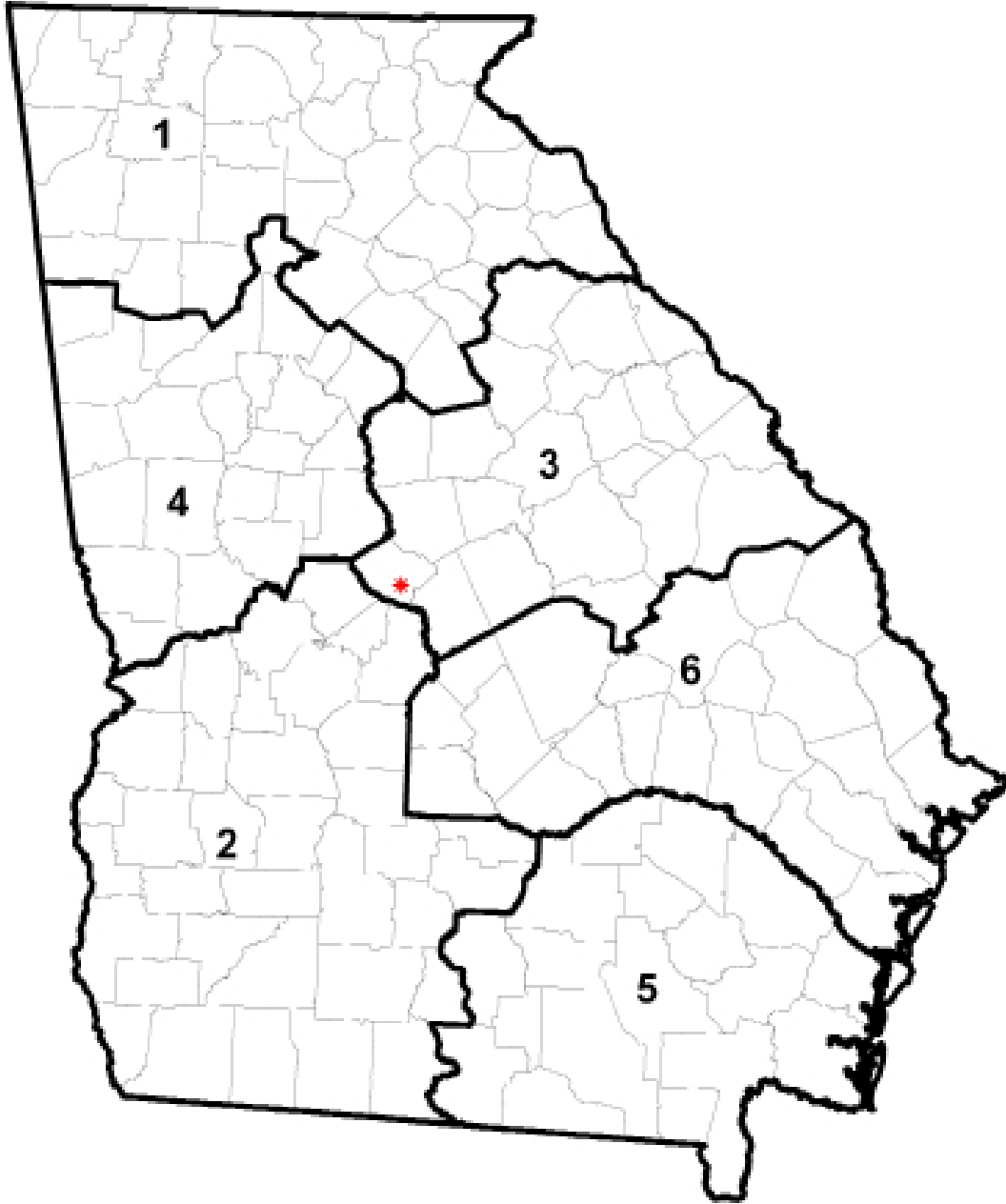

<http://www.gfc.state.ga.us/about-us/contact-us/district-offices/index.cfm>

**Coosa District -1**  
Gainesville, GA  
Rome, GA

**Flint District - 2**  
Camilla, GA  
Americus, GA

**Oconnee District -3**  
Milledgeville, GA  
Washington, GA

**Chattahoochee  
District- 4**  
Newnan, GA

**Satilla District - 5**  
Waycross, GA

**Ogeechee District - 6**  
Helena, GA  
Statesboro, GA

[www.gfc.state.ga.us](http://www.gfc.state.ga.us)



# United States Army Corps of Engineers Georgia Area Sections

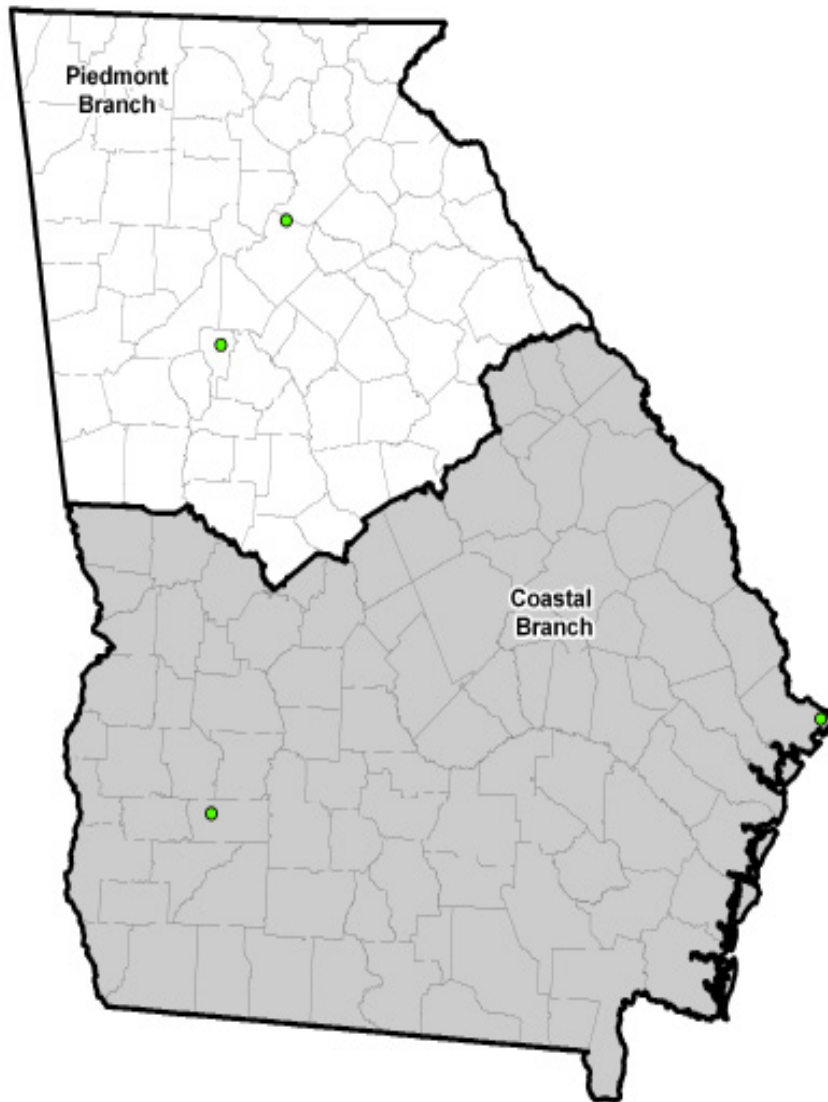

## United States Army Corps of Engineers South Atlantic Division Georgia

### South Atlantic Division

Atlanta, GA

<http://www.sad.usace.army.mil/>

### Savannah District, Regulatory Division

Savannah, GA

<http://www.sas.usace.army.mil/>

Savannah, GA

<http://www.sas.usace.army.mil/Missions/Regulatory/Contacts.aspx>

Morrow, GA

<http://www.sas.usace.army.mil/Missions/Regulatory/Contacts.aspx>

# Georgia Natural Resource Conservation Service Area Offices

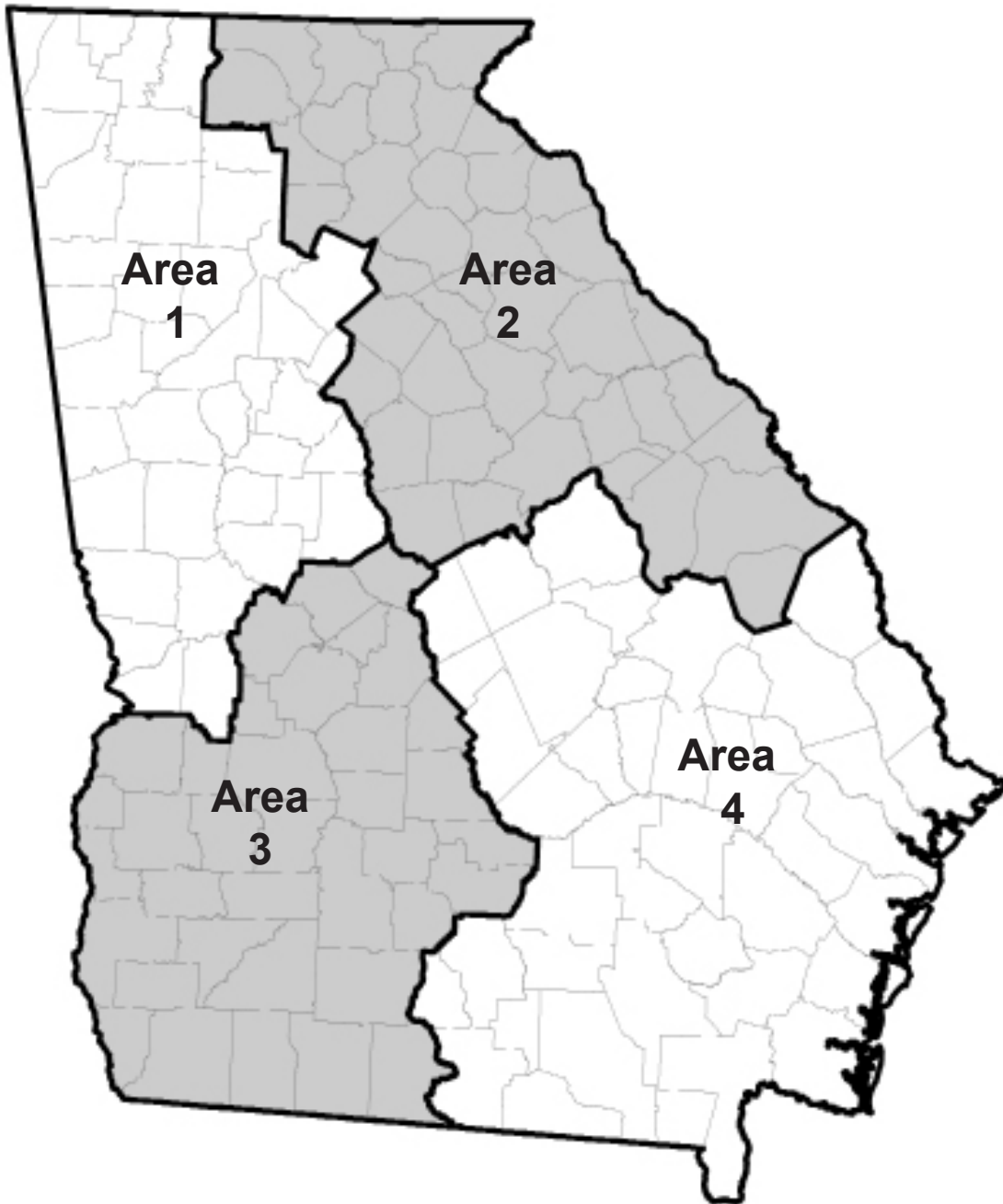

**Area 1**  
Griffin, Georgia

**Area 3**  
Americus, Georgia

**Area 2**  
Athens, Georgia

**Area 4**  
Waycross, Georgia

<http://www.nrcs.usda.gov/wps/portal/nrcs/main/ga/contact/state/>

# CHAPTER 6

## BMP STANDARDS AND SPECIFICATIONS FOR GENERAL LAND-DISTURBING ACTIVITIES

This chapter contains standards and specifications for planning, design and installation of erosion and sediment control measures. They are intended to provide minimum criteria for use at the state and local level. The many variations in climate, soils, topography, physical features and planned land use may require modifications at the local level. Local officials will assure that standards and specifications are implemented in harmony with existing ordinances, rules and regulations.

Variations of these standards have been in use since late the 1930's, when Soil and Water Conservation Districts were first established. Continuing progress through experience and research will require periodic updating. The construction specifications contained herein are not intended to be complete. Detailed construction specifications should be prepared for each land-disturbing activity.

Information has been included on geotextiles based on the American Association of State Highway Transportation Officials (AASHTO). Information on Forestry Best Management Practices can be found in the Georgia Forestry Commission's publication entitled *Georgia's Best Management Practices for Forestry*.

Erosion control is of primary importance during land-disturbing activities, but sediment storage must be available on the site. Temporary sediment basins and retrofitted detention ponds most commonly achieve the required 67 cubic yards per acre of disturbed area of storage. Some situations may call for the use of practices other than those mentioned above. Appropriate sediment storage and perimeter control BMPs must be installed on the site PRIOR to any land-disturbing activities. It is imperative that creative engineering practices are used to ensure that erosion and sediment control BMP's are appropriate for the situation and activity. Linear projects pose special treatment concerning erosion and sediment control.

**Shall** or **Will**, **Should**, and **May** are used in these specifications with the following definitions:

**Shall** or **Will** - A mandatory condition. When certain requirements are described with the "shall" or "will" stipulations, it is mandatory that the requirements be met.

**Should** - An advisory condition. Considered to be recommended but not mandatory.

**May** - A permissive condition. No requirement is intended.

Section I contains standards providing general instructions for the preparation of erosion and sediment control plans for land-disturbing activities.

Section II contains standards and specifications for vegetative type measures for general land-disturbing activities.

Section III contains standards for structural practices and provides instructions for the preparation of erosion and sediment control plans for land-disturbing activities.

Section IV contains tables for design of vegetated diversion, waterway or stormwater conveyance practices.

### **Waters of the United States and Erosion and Sediment Control**

Wetlands are defined as areas that are inundated by surface or ground water for a long enough period of time that the area supports the growth of vegetation that can perpetuate in saturated soil. Wetlands are a valuable resource, and it is imperative that these areas are protected from damage caused by adjacent erosion and subsequent sedimentation. While state law does not necessarily require buffers adjacent to wetlands, these areas are still considered valuable, and all efforts must be made to protect these areas during land disturbing activities. Obviously, the best and most effective method for protecting wetlands is maintaining a buffer between any land-disturbing activity and the wetland. If this is not possible, standard erosion and sediment control devices can be utilized to protect these areas. As always, it is imperative that these devices be designed, installed, and properly maintained.

The Georgia Erosion and Sedimentation (E&S) Act requires that land-disturbing activities in Georgia are protected from erosion and subsequent sedimentation up to and including a 25-year storm. Few realize that activities that impact Waters of the United States can mean stricter Federal requirements for erosion and sediment control. Waters of the United States are navigable waters as well as adjacent wetlands and tributaries to navigable waters. Discharge of dredged or fill material into Waters of the United States is regulated by the United States Army Corps of Engineers under Section 404 of the Clean Water Act (33 U.S.C. 1344).

While State Law requires erosion and sediment control protection for a 25-year storm, Federal Law requires that adequate erosion, sediment and pollution control must be implemented during land-disturbing activities where a section 404 permit (usually known as a wetland permit) is required. Few realize that minor activities of filling and dredging, while not requiring U.S. Army Corps of Engineers notification, still must meet the Federal requirement of “adequate erosion and sediment control” as if a permit had been issued. According to Federal Law, “adequate equates to “no failures tolerated.” In short, when filling or dredging activity impacts any Waters of the United States, adequate erosion control must occur at the site. Therefore, during land-disturbing activities regulated by the state, erosion and sediment control regulations fall under stricter Federal guidelines as well as the standard State guidelines if Waters of the United States are impacted.

To get more information concerning discharge of dredged or fill material into Waters of the United States, permitting for these activities, and stipulations for permitting please visit the website of the United States Army Corps of Engineers, Savannah District, Regulatory branch, <http://www.sas.usace.army.mil>.

# STANDARDS AND SPECIFICATIONS

## SECTION I: LAND-DISTURBING ACTIVITY PLAN

Page

LAND-DISTURBING PLAN.....	6-7
---------------------------	-----

## SECTION II: VEGETATIVE MEASURES

<b>Bf</b> BUFFER ZONE.....	6-15
<b>Cs</b> COASTAL DUNE STABILIZATION.....	6-23
<b>Ds1</b> DISTURBED AREA STABILIZATION (WITH MULCHING ONLY).....	6-27
<b>Ds2</b> DISTURBED AREA STABILIZATION (WITH TEMPORARY SEEDING).....	6-29
<b>Ds3</b> DISTURBED AREA STABILIZATION (WITH PERMANENT VEGETATION).....	6-35
<b>Ds4</b> DISTURBED AREA STABILIZATION (WITH SODDING).....	6-51
<b>Du</b> DUST CONTROL ON DISTURBED AREAS.....	6-55
<b>Fl-Co</b> FLOCCULANTS AND COAGULANTS.....	6-57
<b>Sb</b> STREAMBANK STABILIZATION (USING PERMANENT VEGETATION).....	6-59
<b>Ss</b> SLOPE STABILIZATION.....	6-69
<b>Tac</b> TACKIFIERS.....	6-73

## SECTION III: STRUCTURAL PRACTICES

<b>Cd</b> CHECKDAM.....	6-79
<b>Ch</b> CHANNEL STABILIZATION.....	6-84
<b>Co</b> CONSTRUCTION EXIT.....	6-88

<b>Cr</b>	CONSTRUCTION ROAD STABILIZATION.....	6-90
<b>Dc</b>	STREAM DIVERSION CHANNEL.....	6-94
<b>Di</b>	DIVERSION.....	6-98
<b>Dn1</b>	TEMPORARY DOWNDRAIN STRUCTURE.....	6-102
<b>Dn2</b>	PERMANENT DOWNDRAIN STRUCTURE.....	6-106
<b>Fr</b>	FILTER RING.....	6-108
<b>Ga</b>	GABION.....	6-110
<b>Gr</b>	GRADE STABILIZATION STRUCTURE.....	6-112
<b>Lv</b>	LEVEL SPREADER.....	6-120
<b>Rd</b>	ROCK FILTER DAM.....	6-122
<b>Re</b>	RETAINING WALL.....	6-126
<b>Rt</b>	RETROFIT.....	6-128
<b>Sd1</b>	SEDIMENT BARRIER.....	6-136
<b>Sd2</b>	INLET SEDIMENT TRAP.....	6-146
<b>Sd3</b>	TEMPORARY SEDIMENT BASIN.....	6-156
<b>Sd4</b>	TEMPORARY SEDIMENT TRAP.....	6-184
<b>Sk</b>	FLOATING SURFACE SKIMMER.....	6-190
<b>SpB</b>	SEEP BERM.....	6-196
<b>Sr</b>	TEMPORARY STREAM CROSSING.....	6-200

<b>St</b>	STORM DRAIN OUTLET PROTECTION.....	6-206
<b>Su</b>	SURFACE ROUGHENING.....	6-214
<b>Tc</b>	TURBIDITY CURTAIN.....	6-218
<b>Tp</b>	TOPSOILING.....	6-222
<b>Tr</b>	TREE PROTECTION.....	6-224
<b>Wt</b>	VEGETATED WATERWAY OR STORMWATER CONVEYANCE CHANNEL.....	6-228

**SECTION IV: TABLES FOR DESIGN OF VEGETATED DIVERSION, WATERWAY OR STORMWATER CONVEYANCE PRACTICES**

TABLE 6-39.1

TABLE 6-39.2

TABLE 6-39.3

TABLE 6-39.4





# **SECTION I: LAND-DISTURBING ACTIVITY PLAN**



# LAND-DISTURBING ACTIVITY PLAN

## DEFINITION

A plan that has been properly designed for the control of erosion, sedimentation and pollution resulting from a land-disturbing activity.

## PURPOSE

The proper design of a detailed plan that is in compliance with the Georgia E&S Act, and/or all requirements of the NPDES Permits for construction activities.

## CONDITION

An erosion, sediment and pollution control (ES&PC) plan is required for any land-disturbing activity that is not exempt in O.C.G.A § 12-7-17. Compliance with the NPDES Permits is required for all land-disturbing activities that result in a disturbance equal to or greater than one acre, and all land-disturbing activities that result in less than one acre disturbed when the project is part of a larger common plan of development.

Many land-disturbing activities will require compliance with both the Act and NPDES, some will require compliance with the Act but are exempt from NPDES, some may be exempt from the Act but require compliance with NPDES, and others may be exempt from both the Act and NPDES. The certified design professional preparing the ES&PC Plan should be familiar with all the appropriate requirements.

## PLANNING CRITERIA

The ES&PC Plan shall be designed based upon adequate surveys and resource data, and a site visit by the design professional. Best Management Practices (BMPs) shall be designed in accordance with the applicable standards provided within this Chapter. Practical combinations of the following principles shall be utilized, as a minimum, in planning for any land-disturbing activity.

### 1. Fit the Activity to the Topography and Soils.

Detailed planning should be employed to assure that roadways, buildings and other permanent features of the activity conform to the natural characteristics of the site. Large graded areas should be located on the most level portion of the site. Areas subject to flooding should be avoided.

Areas of steep slopes, erodible soils and soils with severe limitations for the intended uses should not be utilized without overcoming the limitations through sound engineering practices. *Erosion control, development and maintenance costs can be minimized if a site is selected for a specific activity.*

### 2. The Disturbed Area and the Duration of Exposure to Erosion Elements Should Be Minimized.

Clearing of natural vegetation should be limited to only those areas of the site to be developed at a given time. Natural vegetation should be retained, protected and supplemented with construction scheduling employed to limit the duration of soil exposure. Major land clearing and grading operations should be scheduled during seasons of low potential runoff.

### 3. Stabilize Disturbed Areas Immediately.

Permanent structures, temporary or permanent vegetation, and mulch, or a combination of these measures, should be employed as quickly as possible after the land is disturbed. Temporary vegetation and mulches can be most effective on areas where it is not practical to establish permanent vegetation. These temporary measures should be employed immediately after rough grading is completed if a delay is anticipated in obtaining finished grade. The finished slope of a cut or fill should be stable and ease of maintenance considered in the design. Stabilize all roadways, parking areas, and paved areas with the gravel subbase, temporary vegetation or mulch. *Mulch, temporary vegetation, or permanent vegetation shall be completed on all exposed areas within 14 days after disturbance.* Mulch and/or temporary grassing may be used up to six months; permanent vegetation shall be planted if the area is to be left undisturbed for greater than six months.

### 4. Retain or Accommodate Runoff.

Runoff from the development should be safely conveyed to a stable outlet using storm drains, diversions, stable waterways or similar conservation measures. Consideration should also be given to the installation of storm water retention structures to prevent flooding and damage to downstream facilities resulting from increased runoff from the site. Temporary or permanent facilities for conveyance of storm water should

be designed to withstand the velocities of projected peak discharges. These facilities should be operational as soon as possible after the start of construction, and if possible before the disturbance of the surrounding areas.

#### **5.Retain Sediment.**

Appropriate sediment storage providing 67 cubic yards of storage per acre drained for each common drainage location shall be provided until final stabilization of the site. The appropriate initial BMPs must be installed on the site PRIOR to any land-disturbing activities.

#### **6.Do Not Encroach Upon Watercourses.**

Permanent buildings should not be subjected to flooding, sediment damages or erosion hazards. Earth fills should not be constructed in flood-prone areas so as to adversely obstruct water flows or increase downstream velocity of water flows. When necessary to span a flood prone area or watercourse, bridge or culvert openings should be sized to permit passage of peak discharges without causing undue restrictions in water flows or without creating excessive downstream velocities. Uses of flood prone areas should be limited to activities that would not suffer excessive damages from flooding, scour, and sediment damages. Temporary bridges or culverts should be employed when construction equipment is required to cross natural or constructed channels.

### **PLAN REQUIREMENTS**

The ES&PC Plan shall be designed by a "Design Professional," as defined in the NPDES Permits, who must have successfully completed the Level II Introduction to Design Seminar, approved by the GSWCC.

The signature, seal, and level II certification number of the design professional who prepared the plan must be on each sheet of the ES&PC Plan.

The GSWCC provides checklists containing the minimum requirements to be shown on the ES&PC Plans to ensure the plans are in compliance with the E&S Act and the NPDES Permits. The appropriate checklist must be properly completed and included with the ES&PC Plan when plans are submitted for review. Current checklists and guidance documents can be found at <https://gaswcc.georgia.gov/>.

# **SECTION II: VEGETATIVE MEASURES**



## Vegetative Measures

Erosion control should be addressed in the planning stages of all proposed land-disturbing activities. While erosion is difficult to control completely, methods to reduce it are practical, affordable, and cost effective. Erosion control techniques shall be used on all areas exposed for a prolonged period of time, including areas that will be paved or built upon in the future. Various types of vegetative practices are used for erosion control.

The time-line for the implementation of various vegetative practices is as follows:

**Mulch, temporary vegetation, or permanent (perennial) vegetation shall be completed on all exposed areas within 14 days after disturbance.**

**Ds1 - Disturbed Area Stabilization (With Mulching Only)** Mulching can be used as a singular erosion control method on areas at rough grade. Mulch can be an option for up to six months provided that the mulch is applied at the appropriate depth (depending on type of mulch used), anchored, and has a continuous 90% cover or greater of the soil surface. Maintenance shall be required to maintain appropriate depth, anchorage, and 90% cover. If an area will remain undisturbed for greater than six months, permanent (perennial) vegetation shall be used.

**Ds2 - Disturbed Area Stabilization (With Temporary Seeding)** Temporary vegetation may be employed instead of mulch if the area will remain undisturbed for less than six months.

**Ds3 - Disturbed Area Stabilization (With Permanent Vegetation)** Permanent (perennial) vegetation or sod shall be used immediately on areas at final grade. Permanent (perennial) vegetation shall be used on rough graded areas that will be undisturbed for more than six months.

**Ds4 - Disturbed Area Stabilization (With Sodding)** may be used in place of Ds3.

**“Stabilization”** of an area is accomplished when 70 % of the surface area is covered in a uniform, vegetative cover (permanent or temporary) or anchored mulch of the appropriate thickness with 90% coverage. **“Final stabilization”** means that all soil disturbing activities at the site have

been completed, and that for unpaved areas and areas not covered by permanent structures and areas located outside the waste disposal limits of a landfill cell that has been certified by the GA EPD for waste disposal, 100% of the soil surface is uniformly covered in permanent vegetation with a density of 70% or greater, or landscaped according to the Plan (uniformly covered with landscaping materials in planned landscaped areas), or equivalent permanent stabilization measures.

Permanent (perennial) vegetation shall consist of: planted trees, shrubs, perennial vines; a crop of perennial vegetation appropriate for the time of year and region; or a crop of annual vegetation and a seeding of target crop perennials appropriate for the region, such that within the growing season a 70% coverage by perennial vegetation shall be achieved.

For linear construction projects on land used for agricultural or silvicultural purposes, final stabilization may be accomplished by stabilizing the disturbed land for its agricultural or silvicultural use.

For the purposes of this publication, permanent vegetation is used synonymously with perennial vegetation. Perennial vegetation is plant material that lives continuously from year to year although it may have a dormant season when the leaves and possibly the stems “die back” to the ground. No vegetative planting can technically be considered permanent. Annual vegetation is plant material that lives for only one growing season. This type of vegetation is typically used for temporary establishment due to its quick germination. Some perennial vegetation can be used for temporary stabilization.





# Buffer Zone

Bf



## DEFINITION

A strip of undisturbed, original vegetation, enhanced or restored existing vegetation or the re-establishment of vegetation surrounding an area of disturbance or bordering streams, ponds, wetlands, lakes and coastal waters.

## PURPOSE

To provide a buffer zone serving one or more of the following purposes:

- Reduce storm runoff velocities
- Act as screen for “visual pollution”
- Reduce construction noise
- Improve aesthetics on the disturbed land
- Filtering and infiltrating runoff
- Cooling rivers and streams by creating shade provide food and cover for wildlife and aquatic organisms
- Flood protection
- Protect channel banks from scour and erosion

## CONDITIONS

A natural strip of vegetation should be preserved and, if needed, supplemented to form the buffer zone. There are two types of buffer zones.

### General Buffers

A strip of undisturbed, original land surrounding the disturbed site. It can be useful not only

to filter and infiltrate runoff, but also to act as a screen for “visual pollution” and reduce construction noise. General buffers may be enhanced to achieve desired goals.

### Vegetated Stream Buffers

Buffers bordering streams are critical due to the invaluable protection of streams from sedimentation. Stream buffers are also useful in cooling rivers and providing food and cover for wildlife. Refer to the minimum requirements in Act 599 (O.C.G.A. 1-7-1, et. seq.) and Chapters 16 and 18 of the NRCS Engineering Field Handbook.

In most cases, the buffer zone will be incorporated into the permanent vegetative cover. Refer to specification **Ds3 - Disturbed Area Stabilization (With Permanent Vegetation)**.

## DESIGN SPECIFICATIONS

Important design factors such as slope, hydrology, width and structure shall be considered. While Georgia’s Environmental Protection Division enforces minimum stream buffer requirements, expanding the stream buffer width is always encouraged. If any land-disturbing activity, including exempt and non-exempt practices, occurs within the GA EPD mandated stream buffers, cut and fills within the buffer shall be stabilized with appropriate matting or blanket.

### General Buffers

A width should be selected to permit the zone to serve the purpose(s) as listed above. Supplemental plantings may be used to increase the effectiveness of the buffer zone.

### Vegetated Stream Buffers

The structure of vegetated stream buffers should be considered to determine if the buffer must be enhanced to achieve the necessary goals. The size of the stream as well as the topography of the area must be considered to determine the appropriate width of the vegetated stream buffer. A vegetated stream buffer of 50 feet or greater can protect waters from excess sedimentation. The buffer should be increased 2 feet in width for every 1% slope (measured along a line perpendicular to the stream bank). Surface water pollution can be reduced with a 100 foot or wider vegetative buffer.

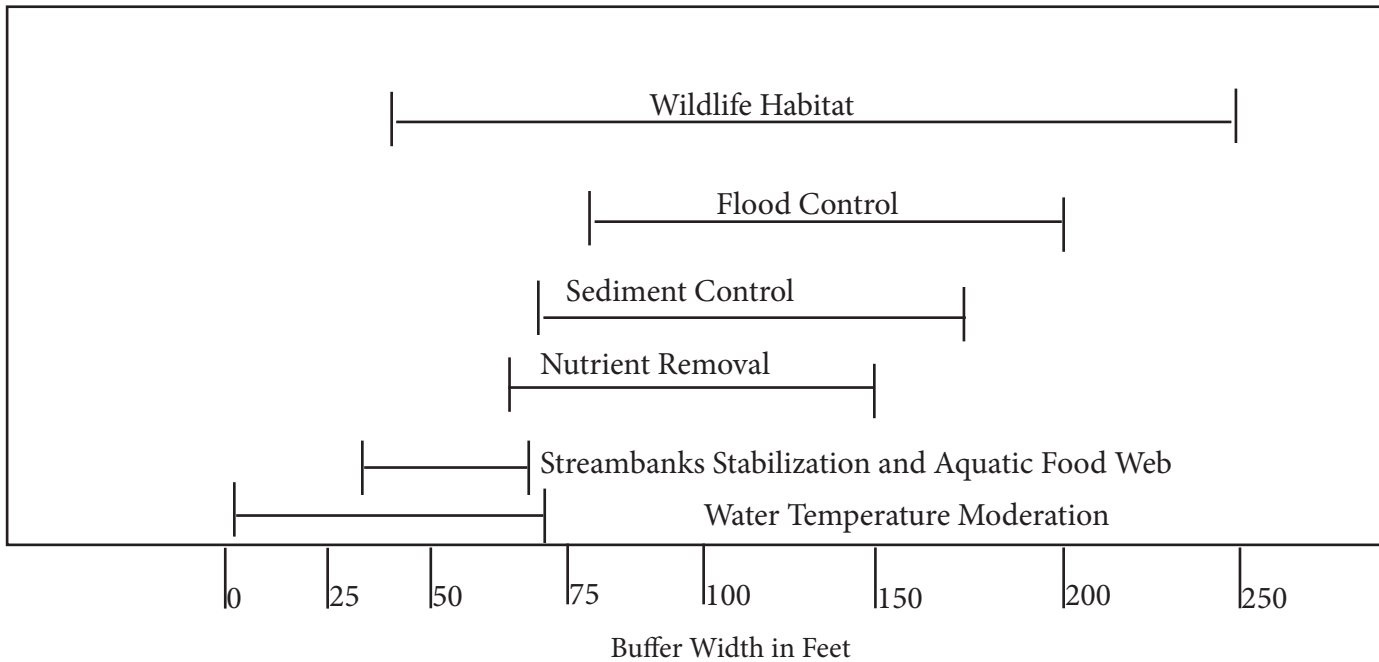

**Figure 6-1.1 - Range of Minimum Width for Meeting Specific Buffer Objectives (Palone and Todd, draft)**

A general multipurpose riparian buffer consists of three zones.

1. Zone 1 The first 20 feet nearest the stream should consist of trees spaced 6-10 feet apart.
2. Zone 2 The next 10 feet should consist of managed forest.
3. Zone 3 The following 20 feet should be comprised of grasses.

This general multipurpose design contains trees and shrubs that help to stabilize stream banks and grasses that spread and reduce the flow from adjacent areas as well as increase settling and infiltration. See Tables 6-1.1 and 6-1.2 for suggested plant species.

If the ideal vegetated buffer width cannot be achieved; narrower buffers can still be used to obtain the goals concerning forest structure and riparian habitat. If this is the case, several design principles should be considered:

1. Sheet flow should be encouraged at the edge of the vegetated stream buffer.
2. The structure of the buffer should consist of under-story and canopy species.

3. The width should be proportional to the watershed area and slope.
4. Native and non-invasive plant species should be used.
5. Density must be considered to determine if the existing buffer must be enhanced to achieve the necessary goals. Vegetation must be dense enough to filter sediment and provide detrital nutrients for aquatic organisms.

Streambank stabilization techniques may be required if steep slopes and hydrologic patterns deem it necessary. Refer to specification **Sb - Streambank Stabilization (Using Permanent Vegetation)**. Vegetated stream buffers on steep slopes may need to be wider to effectively filter overland flow. Corridors subject to intense flooding may require additional streambank stabilization measures.

#### **PLANTING TECHNIQUES**

Plantings for buffer re-establishment and enhancement can consist of bare root seedlings, container-grown seedlings, container-grown plants, and balled and burlapped plants. Refer to Tables 6-1.1 and 6-1.2, and Wildlife Plantings in **Ds3 - Disturbed Area Stabilization (With Permanent Vegetation)**. Standard permanent ero-

sion control grasses and legumes may be used in denuded areas for quick stabilization. Refer to specification **Ds3 - Disturbed Area Stabilization (With Permanent Vegetation)**. Availability, cost, associated risk, equipment, planting procedures, and planting density must be considered when choosing planting types.

Soil preparation and maintenance are essential for the establishment of planted vegetation. Soil fertility, weed control, herbaceous cover, as well as additional associated products may be required.

## **OPERATIONS AND MAINTENANCE**

Areas closest to the stream should be maintained with minimal impact.

### **Watering**

During periods of drought as well as during the initial year, watering may be necessary in all buffer areas planted for enhancement.

### **Weed Control**

Weeds can be removed by hand or with careful spraying.

### **Replanting**

It is imperative that the structure of the vegetated stream buffer be maintained. If the buffer has been planted, it is suggested that the area be monitored to determine if plant material must be replaced. See Tables 6-1.1 and 6-1.2 for suggested plant species. Provisions for the protection of new plantings from destruction or damage from beavers shall be incorporated into the plan.

### **Fertilizer**

If appropriate vegetation is chosen, it is unlikely that fertilizer will be necessary.

### **Local Contacts:**

USDA Natural Resources Conservation Service  
Georgia Forestry Commission

Table 6-1.1 - Unrooted Hardwood Cuttings

Species	Region	Tolerance To Flooding	Tolerance To Drought	Tolerance To Deposition	Tolerance To Shade
<i>Acer negundo</i> Boxelder	C,P,M	H	H	H	L
<i>Baccharis halimifolia</i> Groundsel bush	C,P (lower)	M	M	H	L
<i>Cornus amomum</i> Silly dogwood	P,M	L	M	L	M
<i>Cornus sericea</i> Ssp. sklonifera Red osier dogwood	P,M	L	M	H	M
<i>Crataegus</i> sp. Hawthorn	C,P,M	M	H	L	L
<i>Populus deltoides</i> Eastern cottonwood	C,P,M	M	M	H	L
<i>Salix</i> sp. interior Sandbar willow	C,P,M	H	L	H	L
<i>Salix nigra</i> Black willow	C,P,M	H	H	H	L
<i>Salix purpurea</i> Streamco willow	C,P,M	H	M	H	L
<i>Salix x collesi</i> Bankers willow	P,M	H	M	H	L
<i>Sambucus canadensis</i> American elderberry	P,M	H	M	M	M
<i>Viburnum dentatum</i> Arrowwood viburnum	C,P,M	M	M	M	M
<i>Viburnum lentago</i> Nannyberry viburnum	C,P,M	M	M	L	M

Adapted from the USDA/NRCS Engineering Field Handbook, Chapter 18

## Legend

### Tolerance to Flooding, Drought, Deposition, and Shade:

H = High  
M = Medium  
L = Low

### Region:

C = Coastal  
P = Piedmont  
M = Mountain

Rooting of all species will be improved if nearby vegetation is pruned to increase sunlight penetration.

Whenever possible, harvest hardwood cuttings as close to the repair site as possible. Many of the above grow naturally along streams, in adjacent wetlands, along sewer and power line easements, and where streams enter lakes and along lake shores. Willows generally grow profusely in stormwater detention ponds in urban areas.

**ALWAYS OBTAIN PERMISSION FROM THE PROPERTY OWNER BEFORE HARVESTING PLANTS!**

Table 6-1.2 - Native Plant Guide

NATIVE PLANT GUIDE FOR STREAMBANK  
PLANTING ROOTED STOCK

Species	Region	Stream Zone	Wildlife Value	Notes
<i>Acer rubrum</i> Red Maple	M,P,C	Tree	High seed and browse.	Rapid growth.
<i>Alnus serrulata</i> Smooth alder	M,P,C	Shrub	Moderate, Cover	Rapid growth. Stabilizes streambank. Sun.
<i>Amorpha fruticosa</i> False indigo	M,P,C	Shrub	Moderate	Sun.
<i>Aronia arbutifolia</i> Red chokeberry	M,P,C	Shrub	Moderate cover and food.	Rhizomatous Colonial Shrub.
<i>Asimina triloba</i> Pawpaw	M,P,C	Tree	Important food for fox and possum.	
<i>Betula nigra</i> River Birch	M,P,C	Tree	Good for cavity nester.	Full sun.
<i>Carpinus caroliniana</i> American hophornbeam	M,P,C	Tree	Low	Partial shade.
<i>Carya cordiformis</i> Bitternut hickory	P,C	Tree	Moderate, food	Wet bottoms.
<i>Catalpa bignonioides</i> Catalpa tree	P,C	Tree	Unknown	
<i>Celtis laevigata</i> Sugarberry	P,C	Tree	High food cover	Partial shade.
<i>Celtis occidentalis</i> Hackberry	P,C	Tree	High	Partial shade.
<i>Cephalanthus Occidentalis</i> Buttonbush	M,P,C	Shrub	Moderate, ducks and shorebirds are users. Nectar for hummingbirds.	Sun.
<i>Chionanthus virginicus</i> Fringe tree	P,C	Tree	Moderate	Tolerant of shade. Partial shade.
<i>Clethra alnifolia</i> Sweet pepperbush	P,C	Shrub	Moderate	Good landscape value
<i>Cornus amomum</i> Silly dogwood	M,P	Shrub	High, songbirds, Mammals	Shade tolerant. Good bank stabilizer.
<i>Cornus stricta</i> Swamp dogwood	M,P	Shrub	High	Good bank stabilizer in shade.
<i>Cornus florida</i> Flowering dogwood	M,P,C	Tree	High, birds, food	Shade tolerant.
<i>Cynilla racemiflora</i> Tili	C	Tree	Low	Light shade.
<i>Diospyros Virginia</i> Persimmon	M,P,C	Tree	Extremely high Mammals	Not shade tolerant.
<i>Fraxinus caroliniana</i> Carolina ash	C	Tree	Moderate	Rapid growing. Streambank grower. Sun to partial shade.
<i>Fraxinus pennsylvanica</i> Green ash	M,P,C	Tree	Low	Rapid grower. Full sun.
<i>Gleditsia aquatica</i> Water locust	P,C	Tree	Low	Sun.
<i>Gleditsia triacanthos</i> Honey locust	P,C	Tree	Low	Full sun, thorns.

Table 6-1.2 - Native Plant Guide - continued

Species	Region	Stream Zone	Wildlife Value	Notes
Hibiscus aculeatus Hibiscus Comfort root	C	Shrub	Unknown	Use on open level floodplain areas and Depression in C.
Hibiscus milbaris Hibiscus Half-ber-leaved Marshmallow	C	Shrub	Unknown	Use on open level floodplain areas and Depression in C.
Hibiscus lasiocarpus Hibiscus	C	Shrub	Unknown	Use on open level floodplain areas and
Hibiscus moscheutos Hibiscus	C	Shrub	Unknown	Use on open level floodplain areas and
Ilex cornicea Sweet Galberry	C	Shrub	Unknown	
Ilex decidua Possumhaw	P,C	Shrub	High, food, nest sites.	Sun or shade.
Ilex glabra Bitter galberry or Inkberry	C	Shrub	High	Stoloniferous. Sun to some shade.
Ilex opaca American holly	M,P,C	Tree	High, food, cover nests.	Prefers shade.
Ilex verticillata Winterberry	M,P	Shrub	High, cover and fruits for birds. Holds berries in winter.	Full sun to some shade seasonally flooded areas.
Ilex vomitoria Yaupon	C	Shrub	High, songbirds	Small tree, very adaptable, suckers.
Juglans nigra Black Walnut	M,P	Tree	Good	Temporarily flooded wetlands along
Juniperus virginiana Eastern red cedar	M,P,C	Tree	High, food	Tolerant to some shade in youth.
Leucothoe axillaris Leucothoe	C	Shrub	Low	Partial shade.
Lindera benzoin Common spicebush	M	Shrub	High, songbirds	Shade, acidic soils. Good Understory
Liriodendron tulipifera Tulip poplar	M,P	Tree	Low	Tolerant to partial shade.
Liquidambar styraciflua Sweetgum	M,P,C	Tree	Low	Partial shade.
Lyonia lucida Lyonia or Fetterbush	C	Shrub	Low	Sun.
Magnolia Virginia Sweetbay	P,C	Tree	Very low	Shade tolerant.
Myrica cerifera Southern wax myrtle	C	Shrub	Moderate	Light shade.
Nyssa ogeche Ogeechee lime	C	Tree	High, fruit, cavity nesters.	Wetland tree
Nyssa sylvatica Blackgum or sourgum	M,P,C	Tree	Moderate, seeds	Sun to partial shade.
Nyssa aquatica Swamp tupelo	C	Tree	High	Prefers shade.

Table 6-1.2 - Native Plant Guide - continued

Species	Region	Stream Zone	Wildlife Value	Notes
<i>Ostrya virginiana</i> Hophornbeam	M,P,C	Tree	Moderate	Tolerant of all sunlight conditions.
<i>Persea barbarica</i> Red bay	C	Tree	Good food, for quail and bluebirds.	Underscore tree.
<i>Pinus taeda</i> Loblolly pine	P,C	Tree	Moderate	Poor sites.
<i>Platanus occidentalis</i> Sycamore	M,P,C	Tree	Low. Cavity Nesters	Transplants well. Rapid growth in full sun.
<i>Populus deltoides</i> Eastern cottonwood	M,P,C	Tree	High	Invasive roots. Rapid growth.
<i>Quercus alba</i> White oak	M,P,C	Tree	High, food	Prefers moist well drained soils.
<i>Quercus laurifolia</i> Swamp laurel oak	C	Tree	High	
<i>Quercus lyrata</i> Overcup oak	P,C	Tree	High	Sloughs & bottoms.
<i>Quercus michauxii</i> Swamp chestnut oak	M,P,C	Tree	High	Wetter sites than white oak.
<i>Quercus nigra</i> Water oak	M,P,C	Tree	High	
<i>Quercus pagoda</i> Cherrybark oak	M,P	Tree	High	
<i>Quercus phellos</i> Willow oak	M,P,C	Tree	High, mast	Full to partial sun.
<i>Quercus shumardii</i> Shumard oak	P,C	Tree	High	
<i>Salix nigra</i> Black willow	M,P,C	Shrub & Tree	Nesting	Rapid growth, full sun.
<i>Rhododendron atlanticum</i> Coast azalea	P,C	Shrub	Very low	Very fragrant suckers.
<i>Rhododendron viscosum</i> Swamp azalea	C	Shrub	Low	
<i>Syrax american</i>	C	Shrub	Unknown	
<i>Taxodium distichum</i> Bald cypress	C	Tree	Good perching site	Full sun.
<i>Tsuga canadensis</i> Eastern hemlock	M	Tree	Moderate	Tolerates all light conditions.
<i>Viburnum nudum</i> Swamp haw	M,P,C	Shrub	High	Shade tolerant

## Legend

## Region:

M = Mountains

P = Piedmont

C = Coastal Plain

### **Table 6-1.2 - Native Plant Guide - continued**

#### **Plant List Sources:**

Brown, Claude L. & Kirkman, Katherine L. 1990. Trees of Georgia and Adjacent States.

Foote, Leonard E. & Jones, Samuel B., Jr. 1989. Native Shrubs and Woody Vines of the Southeast.

Georgia Cooperative Extension Service. Native Plants for Georgia Gardens.

Hightshoe, Gary L. 1988. Native Trees, Shrubs and Vines for Urban & Rural America.

USDA Natural Resources Conservation Service. 1973. Seacoast Plants of the Carolinas.

USDA Natural Resources Conservation Service, Engineering Field Handbook, Chapter 18, Soil Bioengineering for Upland Slope Protection and Erosion Reduction.



# Coastal Dune Stabilization (With Vegetation)

Cs



## DEFINITION

Planting vegetation on dunes that are denuded, artificially constructed, or renourished.

## PURPOSE

- To stabilize soil on dunes allowing them to become more resistant to wind and waves.
- To allow development of dunes in areas where they have been damaged or destroyed.

## CONDITIONS

On bare or sparsely vegetated dunes or areas where dune development is desired.

## PLANNING CONSIDERATIONS

Coastal beaches are subject to regulation from a variety of Federal, State, and local agencies. Permits must be requested and granted by all appropriate jurisdictions before work is performed.

Coastal areas are affected by many dynamic systems. Detailed studies are often required to determine the possible effects that may result from dune modifications. Environmental assessments are generally required including public review and comment.

Protection of dunes from human and vehicular traffic is essential if vegetation is to succeed. Crosswalks or crossover structures should be planned to provide beach access.

Plant species that are native to coastal areas

should be used whenever possible.

An irrigation system will be required during the first growing season in order to obtain good survival.

## Common Commercially Available Plants

**Marshhay cordgrass** (*Spartina patens*) “Fla-geo” variety (or native collections) is a perennial grass that occurs on dunes throughout the South Atlantic and Gulf region and in Puerto Rico. It is the dominant plant on dunes composed of broken shale and coquina rock along the northern Florida coast.

The grass is especially tolerant of salt. Stems are slender and grow two to three feet tall. Leaves are rolled inward and resemble rushes. Seed heads are composed of two to several compressed spikes attached at about 90 degrees to the culm. Plants spread by means of a network of slender rhizomes.

Plantings of vegetative material in early spring are most successful. Bare root or potted planting stock is recommended for large plantings. Stems rooted at the base can be planted at a depth of four to five inches deep. Plants that have developed rhizomes are preferred for planting stock.

**Bitter panicum** (*Panicum amarum*) is a perennial grass found on dunes throughout the South Atlantic and Gulf regions. It is most common in South Florida and Texas.

Plants grow to an average height of three to four feet tall. Leaves are smooth and bluish green in color. Seed heads are narrow, compressed, and generally are sparsely seeded. Plants spread from a very aggressive, scattered system of rhizomes, but stands are rather open.

Bitter panicum produces few viable seed but is easier to transplant than sea oats. They can be propagated from a stem with part of the rhizome attached or from rhizomes that are eight to twelve inches long. Plant rhizomes about four inches deep in early spring.

Plants may be propagated by removing all of the stem from robust plants and placing them in the dune at an angle of about 45 degrees. Sev-

eral nodes should be buried. Spacing should be no more than six feet apart.

**Coastal Panicgrass** (*Panicum amarum v. amarulum*) is a somewhat dense, upright perennial bunchgrass found on coastal dunes throughout the South Atlantic and Gulf area. It is the dominant plant at many locations in West Florida, Alabama, and Texas.

The stems are coarse, straight, stiff, and up to four feet tall. Partially compressed seed heads produce moderate amounts of viable seed each fall. The crowns enlarge slowly from short, almost vertical tillers.

Plant seed one to three inches deep in the spring and mulch the area. Seedling survival depends on moisture after germination. Clumps of coastal panicgrass can be dug, divided and planted during rainy seasons or when irrigation is available.

Planting Requirements for Native Plants			
Species	Stock	Date	Depth
Marshhay Cordgrass ( <i>Spartina patens</i> )	Plants	Spring	4"-5"
Bitter Panicum ( <i>Panicum amarum</i> )	Rhizomes	Spring	About 4"
Coastal Panigrass ( <i>Panicum amarum amarulum</i> )	Seeds or plants	Spring	1"-3"

**Sand Fence Use In Building Dunes**

Sand fence may be used to build sand dunes when sand is available. Costs are usually higher but dune development is faster when compared to vegetation alone and generally less expensive than building dunes with machinery.

To form a barrier dune, construct sand fences a minimum of 100 feet from the mean high tide line. Two or more parallel fences spaced from 30 to 40 feet apart are needed. Locate fences as near as possible to a 90 degree angle with the prevailing winds, but as near parallel to the water line as possible.

Where winds are generally parallel with the water



**Figure 6-2.1 - Sand Fence and Native Plants**

line, a single line of fence may be constructed at least 140 feet from the mean high tide. Construct short sections of fence (approximately 30 feet long) parallel to the prevailing wind and approximately perpendicular to the original fence. Place these fences opposite the water side and space these fences about 40 feet apart.

As sand collects over the fence, additional fence can be constructed over the original fence until the desired height is obtained.

Old dunes may be widened by constructing sand fence about 15 feet to the seaward side of the base of the old dune.

Vegetation must be established following development of dunes, or allowed to develop from existing stands as dunes develop.

**SPECIFICATIONS**  
**Sand Fence Specifications**

Use standard commercial 4-foot high snow fence that consists of wooden slats wired together with spaces between the slats. Distance between slats is approximately equal to the slat width, or generally 1 1/4 inches. Slats will be made from grade A or better spruce. Slats will be woven between five two-wire cables of copper-bearing, galvanized wire. Slats will be dipped in a red oxide, weather resistant stain. The fence must be sound, free of decay, broken wire or missing or broken slats.

Fence will be supported by black locust, red cedar, or white cedar posts. Other wood of equal life or strength may be used. Posts will be a minimum of 7 feet with a minimum diameter of three inches. Posts will be spaced no farther than 10 feet apart.

Four wire ties will be used to fasten fence to posts. Weave fence between posts so that every other post will be attached on the ocean side of posts. Tie wires will be no smaller than 12-gauge galvanized wire.

Posts will be set in holes at least three feet deep.

Three or four rows of fence should be used if sufficient land area and sand are available.

## **MAINTENANCE**

### **Maintaining Dunes**

A strong, uniform dune line must be maintained to provide maximum protection from wind and water. Blowouts, wash pits, or other natural or man-made damage must be repaired quickly to prevent weakening of the entire system. Blowouts in a dune system can be repaired by placing sand fence between existing dunes. One or more fences may be required. It is essential to tie the ends of the fence into the existing dune to keep the wind from slipping around the ends. Maintain fences, and erect additional fences if needed, until the eroding area is replenished to the desired height and permanently stabilized.

Foot and vehicular traffic must be controlled or prohibited on dunes to maintain vegetation and prevent excessive sand movement. Elevated walks, semi-permanent paved paths, and portable roll-up walkways are satisfactory. Walkways should be curved to reduce wind movement. Both inland and secondary dunes must be protected from traffic.

### **Vegetative Maintenance**

Plantings are maintained with applications of fertilizer to keep desired density of plants. Annual application of about 50 pounds of nitrogen per acre should be applied. Where vegetation has been destroyed, replanting should be considered.

Figure 6-2.2 - Sand Fence Installation Requirements

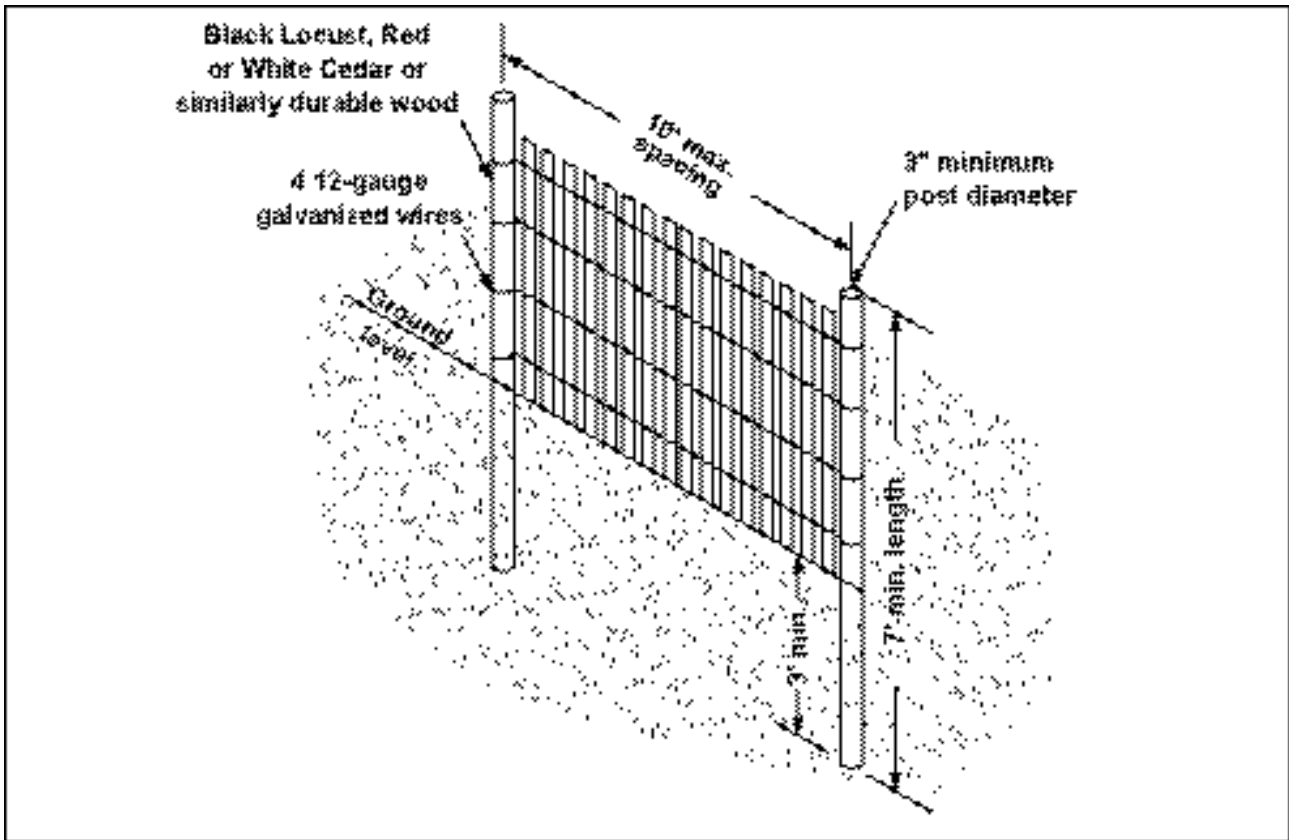

# Disturbed Area Stabilization (With Mulching Only)

Ds1



## DEFINITION

Applying plant residues or other suitable materials, produced on the site if possible, to the soil surface.

## PURPOSE

- To reduce runoff and erosion
- To conserve moisture
- To prevent surface compaction or crusting
- To control undesirable vegetation
- To modify soil temperature
- To increase biological activity in the soil

## REQUIREMENT FOR REGULATORY COMPLIANCE

Mulch or temporary grassing shall be applied to all exposed areas within 14 days of disturbance. Mulch can be used as a singular erosion control device for up to six months, but it shall be applied at the appropriate depth, depending on the material used, anchored and have a continuous 90% cover or greater of the soil surface.

Maintenance shall be required to maintain appropriate depth and 90% cover. Temporary vegetation may be employed instead of mulch if the area will remain undisturbed for less than six months.

If any area will remain undisturbed for greater than six months, permanent vegetative techniques shall be employed. Refer to **Ds2 -Dis-**

**turbed Area Stabilization (With Temporary Seeding), Ds3 - Disturbed Area Stabilization (With Permanent Seeding), and Ds4 - Disturbed Area Stabilization (With Sodding).**

## SPECIFICATIONS

### Mulching Without Seeding

This standard applies to graded or cleared areas where seedings may not have a suitable growing season to produce an erosion retardant cover, but can be stabilized with a mulch cover.

### Site Preparation

1. Grade to permit the use of equipment for applying and anchoring mulch.
2. Install needed erosion control measures as required such as dikes, diversions, berms, terraces and sediment barriers.
3. Loosen compact soil to a minimum depth of 3 inches.

### Mulching Materials

Select one of the following materials and apply at the depth indicated:

1. Dry straw or hay shall be applied at a depth of 2 to 4 inches providing complete soil coverage. One advantage of this material is easy application.
2. Wood waste (chips, sawdust or bark) shall be applied at a depth of 2 to 3 inches. Organic material from the clearing stage of development should remain on site, be chipped, and applied as mulch. This method of mulching can greatly reduce erosion control costs.
3. Polyethylene film shall be secured over banks or stockpiled soil material for temporary protection. This material can be salvaged and re-used.

### Applying Mulch

When mulch is used without seeding, mulch shall be applied to provide full coverage of the exposed area.

1. Dry straw or hay mulch and wood chips shall be applied uniformly by hand or by mechanical equipment.

2. If the area will eventually be covered with perennial vegetation, 20-30 pounds of nitrogen per acre in addition to the normal amount shall be applied to offset the uptake of nitrogen caused by the decomposition of the organic mulches.
3. Apply polyethylene film on exposed areas.

### **Anchoring Mulch**

1. Straw or hay mulch can be pressed into the soil with a disk harrow with the disk set straight or with a special "packer disk." Disks may be smooth or serrated and should be 20 inches or more in diameter and 8 to 12 inches apart. The edges of the disk should be dull enough not to cut the mulch but to press it into the soil leaving much of it in an erect position. Straw or hay mulch shall be anchored immediately after application.

Straw or hay mulch spread with special blower-type equipment may be anchored. Tackifiers, binders and hydraulic mulch with tackifier specifically designed for tacking straw can be substituted for emulsified asphalt. Please refer to specification **Tac-Tackifiers**. Plastic mesh or netting with mesh no larger than one inch by one inch shall be installed according to manufacturer's specifications.

2. Netting of the appropriate size shall be used to anchor wood waste. Openings of the netting shall not be larger than the average size of the wood waste chips.
3. Polyethylene film shall be anchor trenched at the top as well as incrementally as necessary.

# Disturbed Area Stabilization (With Temporary Seeding)

Ds2



## DEFINITION

The establishment of temporary vegetative cover with fast growing seedings for seasonal protection on disturbed or denuded areas.

## PURPOSE

- To reduce runoff and sediment damage of down stream resources
- To protect the soil surface from erosion
- To improve wildlife habitat
- To improve aesthetics
- To improve tilth, infiltration and aeration as well as organic matter for permanent plantings

## REQUIREMENT FOR REGULATORY COMPLIANCE

Mulch or temporary grassing shall be applied to all exposed areas within 14 days of disturbance. Temporary grassing, instead of mulch, can be applied to rough graded areas that will be exposed for less than six months. If an area is expected to be undisturbed for longer than six months, permanent perennial vegetation shall be used. If optimum planting conditions for temporary grassing is lacking, mulch can be used as a singular erosion control device for up to six months but it shall be applied at the appropriate depth, anchored, and have a continuous 90% cover or greater of the soil surface. Refer to specification **Ds1-Disturbed Area Stabilization (With Temporary Seeding)**.

## CONDITIONS

Temporary vegetative measures should be coordinated with permanent measures to assure economical and effective stabilization. Most types of temporary vegetation are ideal to use as companion crops until the permanent vegetation is established. Note: Some species of temporary vegetation are not appropriate for companion crop plantings because of their potential to out-compete the desired species (e.g. annual ryegrass). Contact NRCS or the local SWCD for more information.

## SPECIFICATIONS

### Grading and Shaping

Excessive water run-off shall be reduced by properly designed and installed erosion control practices such as closed drains, ditches, dikes, diversions, sediment barriers and others.

No shaping or grading is required if slopes can be stabilized by hand-seeded vegetation or if hydraulic seeding equipment is to be used.

### Seedbed Preparation

When a hydraulic seeder is used, seedbed preparation is not required. When using conventional or hand-seeding, seedbed preparation is not required if the soil material is loose and not sealed by rainfall.

When soil has been sealed by rainfall or consists of smooth cut slopes, the soil shall be pitted, trenched or otherwise scarified to provide a place for seed to lodge and germinate.

### Lime and Fertilizer

Agricultural lime is required unless soil tests indicate otherwise. Apply agricultural lime at a rate determined by soil test for pH. Quick acting lime should be incorporated to modify pH during the germination period. Bio stimulants should also be considered when there is less than 3% organic matter in the soil. Graded areas require lime application. Soils must be tested to determine required amounts of fertilizer and amendments. Fertilizer should be applied before land preparation and incorporated with a disk, ripper, or chisel. On slopes too steep for, or inaccessible to equipment, fertilizer shall be hydraulically applied, preferably in the first pass with seed and some hydraulic mulch, then topped with the remaining required application rate.

## Seeding

Select a grass or grass-legume mixture suitable to the area and season of the year. Seed shall be applied uniformly by hand, cyclone seeder, drill, culti-packer-seeder, or hydraulic seeder (slurry including seed and fertilizer). Drill or cultipacker seeders should normally place seed one-quarter to one-half inch deep. Appropriate depth of planting is ten times the seed diameter. Soil should be "raked" lightly to cover seed with soil if seeded by hand. See Table 6-4.1

## Mulching

Temporary vegetation can, in most cases, be established without the use of mulch, provided there is little to no erosion potential. However, the use of mulch can often accelerate and enhance germination and vegetation establishment. Mulch without seeding should be considered for short term protection. Refer to **Ds1 - Disturbed Area Stabilization (With Mulching Only)**.

## Irrigation

During times of drought, water shall be applied at a rate not causing runoff and erosion. The soil shall be thoroughly wetted to a depth that will insure germination of the seed. Subsequent applications should be made when needed.



Table 6-4.1 - Temporary Cover or Companion Cover Crops

PLANT, PLANTING RATE, AND PLANTING DATE FOR TEMPORARY COVER OR COMPANION CROPS 1

Species	Broadcast Rates		Resource Area <sup>3</sup>	Planting Dates by Resource Area												Remarks
	Rate Per Acre <sup>1</sup>	Pure Live Seed (PLS) Per 1000 seed		Soil lines indicate optimum dates, dotted lines indicate permissible but marginal dates												
				J	F	M	A	M	J	J	A	S	O	N	D	
<b>BARLEY</b> <i>Hordeum vulgare</i>																
alone	3 bu. (144 lbs)	3.3 lbs	M-L													
in mixture	1/2 bu. (24lbs)	0.8 lb	P C													14,000 seed per pound. Winter hardy. Use on productive soils.
<b>LESPEDEZA, ANNUAL</b> <i>Lespedeza striata</i>																
alone	40 lbs	0.9 lb	M-L													
in mixture	10 lbs	0.2 lb	P C													200,000 seed per pound. May volunteer for several years. Use inoculant EL.
<b>LOVEGRASS, WEEPING</b> <i>Eragrostis curvula</i>																
alone	4 lbs	0.1 lb	M-L													
in mixture	2 lbs	0.05 lb	P C													1,500,000 seed per pound. May last for several years. Mix with <i>Sternia lespedeza</i> .
<b>MILLET, BROWNTOP</b> <i>Panicum fasciculatum</i>																
alone	40 lbs	0.9 lb	M-L													
in mixture	10 lbs	0.2 lb	P C													137,000 seed per pound. Quick dense cover. Will provide excessive competition in mixtures if seeded at high rate.

Species	Broadcast Rates	Resource Area <sup>3</sup>	Planting Dates by Resource Area												Remarks
			<i>Solid lines indicate optimum dates, dotted lines indicate permissible but marginal dates.</i>												
	Pure Live Seed (PLS) Per 1000 Rate Per Acre <sup>3</sup> soft		J	F	M	A	M	J	J	A	S	O	N	D	
MILLET, PEARL <i>Pennisetum glaucum</i> alone	50 lbs 1.1 lbs	M-L P C													88,000 seed per pound. Quick dense cover. May reach 5 feet in height. Not recommended for mixtures.
OATS <i>Avena sativa</i> alone in mixture	4 bu. (128 lbs) 1 bu. (32 lbs) 2.8 lbs D.7 lb	M-L P C													13,000 seed per pound. Use on productive soils. Not as winter hardy as rye or barley.
RYE <i>Secale cereale</i> alone in mixture	3 bu. (168 lbs) 1/2 bu. (28 lbs) 3.8 lbs D.8 lb	M-L P C													18,000 seed per pound. Quick cover. Drought tolerant and winter hardy.
RYEGRASS, ANNUAL <i>Lolium temulentum</i> alone	40 lbs D.9 lb	M-L P C													227,000 seed per pound. Dense cover. Very competitive and is not to be used in mixtures.
SUDANGRASS <i>Sorghum sudanese</i> alone	80 lbs 1.4 lbs	M-L P C													56,000 seed per pound. Good on droughty sites. Not recommended for mixtures.

Species	Broadcast Rates	Resource Area <sup>3</sup>	Planting Dates by Resource Area												Remarks		
			J	F	M	A	M	J	J	A	S	O	N	D			
TRITICALE X-Triticosecale	Rate Per Acre  Pure Live Seed (PLS) Per 1000 sqft																
alone	3 bu. (144 lbs)	3.3 lbs															
in mixture	1/2 bu. (24 lbs)	0.8 lb															Use on lower part of Southern Coastal Plain and in Atlantic Coastal Flatwoods only.
WHEAT <i>Triticum aestivum</i>																	
alone	3 bu. (180 lbs)	4.1 lbs															
in mixture	1/2 bu. (30 lbs)	0.7 lb															15,000 seed per pound. Winter hardy.

<sup>1</sup>Temporary cover crops are very competitive and will crowd out perennials if seeded too heavily

<sup>2</sup>Reduce seeding rates by 50% when drilled.

M-L represents the Mountain, Blue Ridge, and Ridge and Valley MURAs

P represents the Southern Piedmont MURA

C represents Southern Coastal Plain, Sand Hill, Black Land, and Atlantic Coastal Flatwoods MURAs

(see Figure E-4.1, p. 6-43)

# GEORGIA

## Major Land Resource Areas

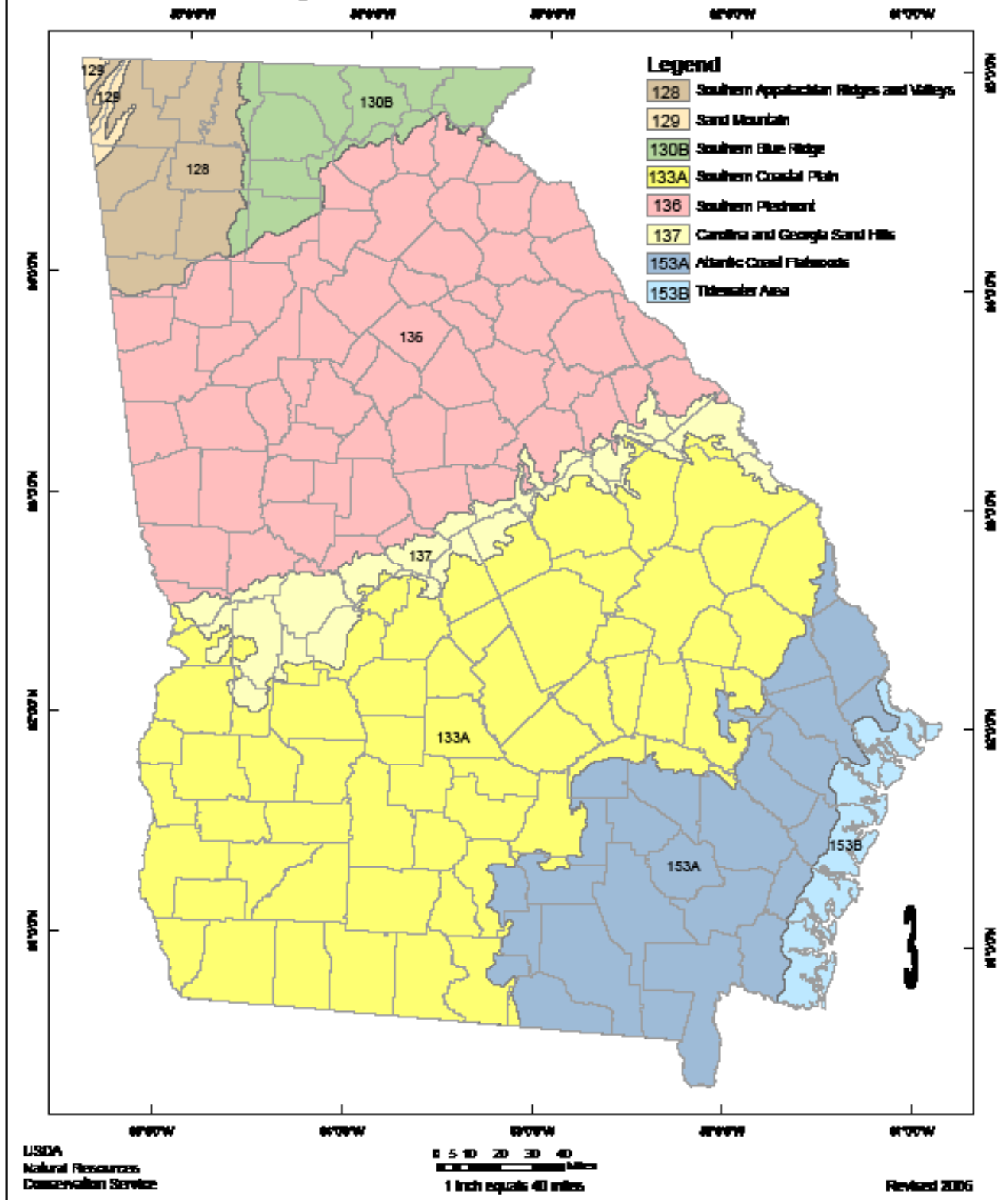

Figure 6-4.1

# Disturbed Area Stabilization (With Permanent Vegetation)

Ds3



## DEFINITION

The planting of perennial vegetation such as trees, shrubs, vines, grasses, or legumes on exposed areas for final permanent stabilization. Permanent perennial vegetation shall be used to achieve final stabilization.

## PURPOSE

- To protect the soil surface from erosion
- To reduce damage from sediment and runoff to down-stream areas
- To improve wildlife habitat and visual resources
- To improve aesthetics

## REQUIREMENT FOR REGULATORY COMPLIANCE

This practice shall be applied immediately to rough graded areas that will be undisturbed for longer than six months. This practice or sodding shall be applied immediately to all areas at final grade. **Final Stabilization** means that all soil disturbing activities at the site have been completed, and that for unpaved areas and areas not covered by permanent structures and areas located outside the waste disposal limits of a landfill cell that has been certified by the GA EPD for waste disposal, 100% of the soil surface is uniformly covered in permanent vegetation with a density of 70% or greater, or landscaped according to the Plan (uniformly covered with landscaping materials in planned landscaped areas), or equivalent permanent stabilization measures.

Permanent vegetation shall consist of, planted trees, shrubs, perennial vines; or a crop of perennial vegetation appropriate for the region, such that within the growing season a 70% coverage by perennial vegetation shall be achieved. Final stabilization applies to each phase of construction. For linear construction projects on land used for agricultural or silvicultural purposes, final stabilization may be accomplished by stabilizing the disturbed land for its agricultural or silvicultural use. Until this standard is satisfied and permanent control measures and facilities are operational, interim stabilization measures and temporary erosion and sedimentation control measures shall not be removed.

## CONDITIONS

Permanent perennial vegetation is used to provide a protective cover for exposed areas including cuts, fills, dams, and other denuded areas.

## PLANNING CONSIDERATIONS

1. Use conventional planting methods where possible.
2. When mixed plantings are done during marginal planting periods, companion crops shall be used.
3. No-till planting is effective when planting is done following a summer or winter annual cover crop. Sericea lespedeza planted no-till into stands of rye is an excellent procedure.
4. Block sod provides immediate cover. It is especially effective in controlling erosion adjacent to concrete flumes and other structures. Refer to Specification **Ds4-Disturbed Area Stabilization (With Sodding)**.
5. Irrigation should be used when the soil is dry or when summer plantings are done.
6. Low maintenance plants, as well as natives, should be used to ensure long-lasting erosion control.
7. Mowing should not be performed during the quail nesting season (May to September).
8. Wildlife plantings should be included in critical area plantings.

## **Wildlife Plantings**

Commercially available plants beneficial to wildlife species include the following:

### *Mast Bearing Trees*

Beech, Black Cherry, Blackgum, Chestnut, Chinkapin, Hackberry, Hickory, Honey Locust, Native Oak, Persimmon, Sawtooth Oak and Sweetgum.

All trees that produce nuts or fruits are favored by many game species. Hickory provides nuts used mainly by squirrels and bear.

### *Shrubs and Small Trees*

Bayberry, Bicolor Lespedeza, Crabapple, Dogwood, Huckleberry or Native Blueberry, Mountain Laurel, Native Holly, Red Cedar, Red Mulberry, Sumac, Wax Myrtle, Wild Plum and Blackberry.

Plant in patches without tall trees to develop stable shrub communities. All produce fruits used by many kinds of wildlife, except for lespedeza that produces seeds used by quail and songbirds.

### *Grasses, Legumes, Vines and Temporary Cover*

Bahiagrass, Bermudagrass, Grass-Legume mixtures, Partridge Pea, Annual Lespedeza, Orchardgrass (for mountains), Browntop Millet (for temporary cover), and Native grapes.

Provides herbaceous cover in clearings for a game bird brood-rearing habitat. Appropriate legumes such as vetches, clovers, and lespedezas may be mixed with grass, but they may die out after a few years.

## **CONSTRUCTION SPECIFICATIONS**

### **Grading and Shaping**

Grading and shaping may not be required where hydraulic seeding and fertilizing equipment is to be used. Vertical banks shall be sloped to enable plant establishment.

When conventional seeding and fertilizing are to be done, grade and shape where feasible and practical, so that equipment can be used safely and efficiently during seedbed preparation, seeding, mulching and maintenance of the vegetation.

Concentrations of water that will cause excessive

soil erosion shall be diverted to a safe outlet. Diversions and other treatment practices shall conform with the appropriate standards and specifications.

### **Lime and Fertilizer Rates and Analysis**

Agricultural lime is required at the rate of one to two tons per acre unless soil tests indicate otherwise. Graded areas require lime application. If lime is applied within six months of planting permanent perennial vegetation, additional lime is not required. Agricultural lime shall be within the specifications of the Georgia Department of Agriculture.

Lime spread by conventional equipment shall be "ground limestone." Ground limestone is calcitic or dolomitic limestone ground so that 90 percent of the material will pass through a 10-mesh sieve, not less than 50 percent will pass through a 50-mesh sieve and not less than 25 percent will pass through a 100-mesh sieve.

Fast-acting lime spread by hydraulic seeding equipment should be "finely ground limestone" spanning from the 180 micron size to the 5 micron size. Finely ground limestone is calcitic or dolomitic limestone ground so that 95 percent of the material will pass through a 100-mesh sieve.

It is desirable to use dolomitic limestone in the Sand Hills, Southern Coastal Plain and Atlantic Coast Flatwoods MLRAs. (See Figure 6-4.1)

Agricultural lime is generally not required where only trees are planted.

Initial fertilization, nitrogen, topdressing, and maintenance fertilizer requirements for each species or combination of species are listed in Table 6-5.1.

### **Lime and Fertilizer Application**

When *hydraulic seeding* equipment is used, the initial fertilizer shall be mixed with seed, inoculant (if needed), and wood cellulose or wood pulp fiber mulch and applied in a slurry. The inoculant, if needed, shall be mixed with the seed prior to being placed into the hydraulic seeder. The slurry mixture will be agitated during application to keep the ingredients thoroughly mixed. The mixture will be spread uniformly over the area within one hour after being placed in the

hydroseeder.

Finely ground limestone can be applied in the mulch slurry or in combination with the top dressing.

When *conventional planting* is to be done, lime and fertilizer shall be applied uniformly in one of the following ways:

1. Apply before land preparation so that it will be mixed with the soil during seedbed preparation.
2. Mix with the soil used to fill the holes, distribute in furrows.
3. Broadcast after steep surfaces are scarified, pitted or trenched.
4. A fertilizer pellet shall be placed at root depth in the closing hole beside each pine tree seedling.

### Plant Selection

Refer to Tables 6-4.1, 6-5.2, 6-5.3 and 6-5.4 for approved species. Species not listed shall be approved by the State Resource Conservationist of the Natural Resources Conservation Service before they are used.

Plants shall be selected on the basis of species characteristics, site and soil conditions, planned use and maintenance of the area; time of year of planting, method of planting; and the needs and desires of the land user.

Some perennial species are easily established and can be planted alone. Examples of these are Common Bermuda, Tall Fescue, and Weeping Lovegrass.

Other perennials, such as Bahia Grass and Sericea Lespedeza, are slow to become established and should be planted with another perennial species. The additional species will provide quick cover and ample soil protection until the target perennial species become established. For example, Common seeding combinations are 1) Weeping Lovegrass with Sericea Lespedeza (scarified) and 2) Tall Fescue with Sericea Lespedeza (unscarified).

Plant selection may also include annual companion crops. Annual companion crops should be used only when the perennial species are not planted during their optimum planting period. A common

mixture is Brown Top Millet with Common Bermuda in mid-summer. Care should be taken in selecting companion crop species and seeding rates because annual crops will compete with perennial species for water, nutrients, and growing space. A high seeding rate of the companion crop may prevent the establishment of perennial species.

**Ryegrass shall not be used in any seeding mixtures containing perennial species due to its ability to out-compete desired species chosen for permanent perennial cover.**

### Seed Quality

The term "pure live seed" is used to express the quality of seed and is not shown on the label. Pure live seed, PLS, is expressed as a percentage of the seeds that are pure and will germinate. Information on percent germination and purity can be found on seed tags. PLS is determined by multiplying the percent of pure seed with the percent of germination; i.e.,

**(PLS = % germination x % purity)**

EXAMPLE:

Common Bermuda seed  
70% germination, 80% purity

PLS = 70% germination x 80% purity

PLS = 56%

The percent of PLS helps you determine the amount of seed you need. If the seeding rate is 10 pounds PLS and the bulk seed is 56 % PLS, the bulk seeding rate is:

$$\frac{10 \text{ lbs. PLS/acre}}{56\% \text{ PLS}} = 17.9 \text{ lbs/acre}$$

You would need to plant 17.9 lbs/acre to provide 10 lbs/acre of pure live seed.

### Seedbed Preparation

Seedbed preparation may not be required where hydraulic seeding and fertilizing equipment is to be used (but is strongly recommended for any seeding process, when possible). When conventional seeding is to be used, seedbed preparation will be done as follows:

#### *Broadcast plantings*

1. Tillage, at a minimum, shall adequately

loosen the soil to a depth of 4 to 6 inches; alleviate compaction; incorporate lime and fertilizer; smooth and firm the soil; allow for the proper placement of seed, sprigs, or plants; and allow for the anchoring of straw or hay mulch if a disk is to be used.

2. Tillage may be done with any suitable equipment.
3. Tillage should be done on the contour where feasible.
4. On slopes too steep for the safe operation of tillage equipment, the soil surface shall be pitted or trenched across the slope with appropriate hand tools to provide two places 6 to 8 inches apart in which seed may lodge and germinate. Hydraulic seeding may also be used.

#### *Individual Plants*

1. Where individual plants are to be set, the soil shall be prepared by excavating holes, opening furrows, or dibble planting.
2. For nursery stock plants, holes shall be large enough to accommodate roots without crowding.
3. Where pine seedlings are to be planted, subsoil under the row 36 inches deep on the contour four to six months prior to planting. Subsoiling should be done when the soil is dry, preferably in August or September.

#### **Innoculants**

All legume seed shall be inoculated with appropriate nitrogen-fixing bacteria. The inoculant shall be a pure culture prepared specifically for the seed species and used within the dates on the container.

A mixing medium recommended by the manufacturer shall be used to bond the inoculant to the seed. For conventional seeding, use twice the amount of inoculant recommended by the manufacturer. For hydraulic seeding, four times the amount of inoculant recommended by the manufacturer shall be used.

All inoculated seed shall be protected from the sun and high temperatures and shall be planted

the same day inoculated. No inoculated seed shall remain in the hydroseeder longer than one hour.

#### **Planting**

##### *Hydraulic Seeding*

Mix the seed (innoculated if needed), fertilizer, and wood cellulose or wood pulp fiber mulch with water and apply in a slurry uniformly over the area to be treated. Apply within one hour after the mixture is made.

##### *Conventional Seeding*

Seeding will be done on a freshly prepared and firmed seedbed. For broadcast planting, use a culti-packer-seeder, drill, rotary seeder, other mechanical seeder, or hand seeding to distribute the seed uniformly over the area to be treated. Cover the seed lightly with 1/8 to 1/4 inch of soil for small seed and 1/2 to 1 inch for large seed when using a cultipacker or other suitable equipment.

##### *No-Till Seeding*

No-till seeding is permissible into annual cover crops when planting is done following maturity of the cover crop or if the temporary cover stand is sparse enough to allow adequate growth of the permanent (perennial) species. No-till seeding shall be done with appropriate no-till seeding equipment. The seed must be uniformly distributed and planted at the proper depth.

##### *Individual Plants*

Shrubs, vines and sprigs may be planted with appropriate planters or hand tools. Pine trees shall be planted manually in the subsoil furrow. Each plant shall be set in a manner that will avoid crowding the roots.

Nursery stock plants shall be planted at the same depth or slightly deeper than they grew at the nursery. The tips of vines and sprigs must be at or slightly above the ground surface.

Where individual holes are dug, fertilizer shall be placed in the bottom of the hole, two inches of soil shall be added and the plant shall be set in the hole.

#### **Mulching**

*Mulch is required for all permanent vegetation applications.* Mulch applied to seeded areas shall achieve 75% to 100% soil cover. When selecting a mulch, design professionals should consider the mulch's functional longevity, vegeta-



tion establishment enhancement, and erosion control effectiveness. Select the mulching material from the following and apply as indicated:

1. *Dry straw* or *dry hay* of good quality and free of weed seeds can be used. Dry straw shall be applied at the rate of 2 tons per acre. Dry hay shall be applied at a rate of 2 1/2 tons per acre.
2. *Wood cellulose mulch* or *wood pulp fiber* shall be used with hydraulic seeding. It shall be applied at the rate of 500 pounds per acre. Dry straw or dry hay shall be applied (at the rate indicated above) after hydraulic seeding.
3. One thousand pounds of *wood cellulose* or *wood pulp fiber*, which includes a tackifier, shall be used with hydraulic seeding on slopes 3/4:1 or steeper.
4. *Sericea Lespedeza* hay containing mature seed shall be applied at a rate of three tons per acre.
5. *Pine straw* or *pine bark* shall be applied at a thickness of 3 inches for bedding purposes. Other suitable materials in sufficient quantity may be used where ornamentals or other ground covers are planted. This is not appropriate for seeded areas.
6. When using temporary erosion control blankets or block sod, mulch is not required.
7. *Bituminous treated roving* may be applied on planted areas, slopes, in ditches or dry waterways to prevent erosion. Bituminous treated roving shall be applied within 24 hours after an area has been planted. Application rates and materials must meet Georgia Department of Transportation specifications.

Wood cellulose and wood pulp fibers shall not contain germination or growth inhibiting factors. They shall be evenly dispersed when agitated in water. The fibers shall contain a dye to allow visual metering and aid in uniform application during seeding.

### **Applying Mulch**

*Straw or hay mulch* will be spread uniformly within 24 hours after seeding and/or plant-

ing. The mulch may be spread by blower-type spreading equipment, other spreading equipment or by hand. Mulch shall be applied to cover 75% of the soil surface.

*Wood cellulose or wood fiber mulch* shall be applied uniformly with hydraulic seeding equipment.

### **Anchoring Mulch**

Anchor straw or hay mulch immediately after application by one of the following methods:

1. *Hay and straw* mulch shall be pressed into the soil immediately after the mulch is spread. A special "packer disk" or disk harrow with the disks set straight may be used. The disks may be smooth or serrated and should be 20 inches or more in diameter and 8 to 12 inches apart. The edges of the disks shall be dull enough to press the mulch into the ground without cutting it, leaving much of it in an erect position. Mulch shall not be plowed into the soil.
2. *Synthetic tackifiers, binders or hydraulic mulch specifically designed to tack straw*, shall be applied in conjunction with or immediately after the mulch is spread. Synthetic tackifiers shall be mixed and applied according to manufacturer's specifications. All tackifiers, binders or hydraulic mulch specifically designed to tack straw should be verified nontoxic through EPA 2021.0 testing. Refer to **Tackifiers-Tac**
3. *Rye or wheat* can be included with Fall and Winter plantings to stabilize the mulch. They shall be applied at a rate of one-quarter to one-half bushel per acre.
4. *Plastic mesh or netting* with mesh no larger than one inch by one inch may be needed to anchor straw or hay mulch on unstable soils and concentrated flow areas. These materials shall be installed and anchored according to manufacturer's specifications.

### **Bedding Material**

Mulch is used as a bedding material to conserve moisture and control weeds in nurseries, ornamental beds, around shrubs, and on bare areas on lawns.

<b><u>Material</u></b>	<b><u>Depth</u></b>
Grain straw	4" to 6"
Grass Hay	4" to 6"
Pine needles	3" to 5"
Wood waste	4" to 6"

### **Irrigation**

Irrigation will be applied at a rate that will not cause runoff.

### **Topdressing**

Topdressing will be applied on all temporary and permanent (perennial) species planted alone or in mixtures with other species. Recommended rates of application are listed in Table 6-5.1.

### **Second Year and Maintenance Fertilization**

Second year fertilizer rates and maintenance fertilizer rates are listed in Table 6-5.1.

### **Lime Maintenance Application**

Apply one ton of agricultural lime every 4 to 6 years or as indicated by soil tests. Soil tests can be conducted to determine more accurate requirements, if desired.

### **Use and Management**

Mow Sericea Lespedeza only after frost to ensure that the seeds are mature. Mow between November and March.

Bermudagrass, Bahiagrass and Tall Fescue may be mowed as desired. Maintain at least 6 inches of top growth under any use and management. Moderate use of top growth is beneficial after establishment.

Exclude traffic until the plants are well established. Because of the quail nesting season, mowing should not take place between May and September.

**Table 6-5.1. Fertilizer Requirements**

TYPE OF SPECIES	YEAR	ANALYSIS OR EQUIVALENT N-P-K	RATE	N TOP DRESSING RATE
1. Cool season grasses	First	6-12-12	1500 lbs./ac.	50-100 lbs./ac. 1/2/
	Second	6-12-12	1000 lbs./ac.	—
	Maintenance	10-10-10	400 lbs./ac.	30
2. Cool season grasses and legumes	First	6-12-12	1500 lbs./ac.	0-50 lbs./ac. 1/
	Second	0-10-10	1000 lbs./ac.	—
	Maintenance	0-10-10	400 lbs./ac.	—
3. Ground covers	First	10-10-10	1300 lbs./ac. 3/	—
	Second	10-10-10	1300 lbs./ac. 3/	—
	Maintenance	10-10-10	1100 lbs./ac.	—
4. Pine seedlings	First	20-10-5	one 21-gram pellet per seedling placed in the closing hole	—
5. Shrub Lespedeza	First	0-10-10	700 lbs./ac.	—
	Maintenance	0-10-10	700 lbs./ac. 4/	—
6. Temporary cover crops seeded alone	First	10-10-10	500 lbs./ac.	30 lbs./ac. 5/
7. Warm season grasses	First	6-12-12	1500 lbs./ac.	50-100 lbs./ac. 2/6/
	Second	6-12-12	800 lbs./ac.	50-100 lbs./ac. 2/
	Maintenance	10-10-10	400 lbs./ac.	30 lbs./ac.
8. Warm season grasses and legumes	First	6-12-12	1500 lbs./ac.	50 lbs./ac./6/
	Second	0-10-10	1000 lbs./ac.	
	Maintenance	0-10-10	400 lbs./ac.	

1/ Apply in spring following seeding.

2/ Apply in split applications when high rates are used.

3/ Apply in 3 split applications.

4/ Apply when plants are pruned.

5/ Apply to grass species only.

6/ Apply when plants grow to a height of 2 to 4 inches.

**Table 6-5.2- Permanent Cover Crops  
PLANT, PLANTING RATE, AND PLANTING DATE FOR PERMANENT COVER 1**

Species	Broadcast Rates	Resource Area <sup>3</sup>	Planting Dates by Resource Area												Remarks
			Solid lines indicate optimum dates, dotted lines indicate permissible but marginal dates												
	Pure Line Seed (PLS) Rate Per Acre <sup>4</sup> Per 1000 sqft		J	F	M	A	M	J	J	A	S	O	N	D	
BAHIA, PENSACOLA <i>Paspalum notatum</i>															
alone or with temporary cover	80 lbs	P													
with other perennials	30 lbs	C													
100,000 seed per pound. Low growing. Sod forming. Slow to establish. Plant with a companion crop. Will spread into bermuda pastures and awms. Mix with Sericea lespedeza or weeping lovegrass.	1.4 lbs														
BAHIA, WILMINGTON <i>Paspalum notatum</i>															
alone or with temporary cover	80 lbs	M-L													
with other perennials	30 lbs	P													
1,787,000 seed per pound. Quick cover. Low growing and sod forming. Full sun. Good for athletic fields.	1.4 lb														
BERMUDA, COMMON <i>Cynodon dactylon</i>															
Hulled seed	10 lbs	P													
alone	8 lbs	C													
with other perennials	0.7 lb														
BERMUDA, COMMON <i>Cynodon dactylon</i>															
Unhulled seed	10 lbs	P													
with temporary cover	8 lbs	C													
with other perennials	0.1 lb														
Plant with winter annuals.															
Plant with Tall Fescue															

**Table 6-5.2- Permanent Cover Crops  
PLANT, PLANTING RATE, AND PLANTING DATE FOR PERMANENT COVER 1**

Species	Broadcast Rates	Resource Area <sup>3</sup>	Planting Dates by Resource Area												Remarks
			Solid lines indicate optimum dates, dashed lines indicate permissible but marginal dates.												
	Pure Live Seed (PLS) Rate Per Acre <sup>3</sup> Per 1000 sqft		J	F	M	A	M	J	J	A	S	O	N	D	
BERMUDA SPRIGS <i>Cynodon dactylon</i>															
Coastal, Common, Midland, or TIF 44	40 cu ft D.9 cu ft or sod plugs 3' x3'	M-L													A cubic foot contains approximately 650 sprigs. A bushel contains 1.25 cubic feet or approximately 800 sprigs.
		P												Same as above.	
		C													
TIF 78		C													Southern Coastal Plain only
CENTIPEDE <i>Eremochloa ophiuroides</i>	Block seed only	P													Drought tolerant. Full sun or partial shade. Effective adjacent to concrete and in concentrated flow areas. Irrigation is needed until fully established. Do not plant near pastures. Winterhardy as far as north Athens and Atlanta.
		C													
CROWNVETECH <i>Coronilla varia</i>															
with winter annuals or cool season grasses	15 lbs 0.3 lb	M-L													100,000 seed per pound. Dense growth. Drought tolerant and fire resistant. Attractive rose, pink and white blossoms spring to late fall. Mix with 30 pounds of Tall fescue or 15 pounds of rye. Inoculate see with M inoculant. Use from North Atlanta and Northward.
		P													

**Table 6-5.2- Permanent Cover Crops  
PLANT, PLANTING RATE, AND PLANTING DATE FOR PERMANENT COVER 1**

Species	Broadcast Rates	Resource Area <sup>a</sup>	Planting Dates by Resource Area												Remarks
			Solid lines indicate optimum dates, dotted lines indicate permissible but marginal dates												
	<i>Pure Live Seed (PLS) Rate Per Acre<sup>b</sup> Per 1000 sqft</i>		J	F	M	A	M	J	J	A	S	O	N	D	
FESCUE, TALL <i>Festuca arundinacea</i>															
alone	50 lbs	MHL													227,000 seed per pound. Use alone only on better sites. Mix with perennial lespedeza or Crownvetch. Apply topdressing in spring following fall plantings. Not for heavy use on areas or athletic fields.
with other perennials	30 lbs	P													
KUDZU <i>Pueraria thumbergiana</i>															
Plants or crowns	3 - 7 apart	ALL													Rapid and vigorous growth. Excellent in gully erosion control. Will climb. Good livestock forage.
LESPEDEZA SERICEA <i>Lespedeza cuneata</i>															
scarified	80 lbs	MHL P C													350,000 seed per pound. Widely adapted. Low maintenance. Mix with Weeping lovegrass, Common bermuda, bahia, or tall fescue. Takes 2 to 3 years to become fully established. Excellent on roadbanks. Inoculate seed with EL inoculant.
unscarified	75 lbs	MHL P C													Mix with Tall fescue or winter annuals.
seed-bearing hay	3 tons	MHL P C													Cut when seed maturity is mature, but before, it sheathers. Add Tall fescue or winter annuals.

**Table 6-5.2- Permanent Cover Crops  
PLANT, PLANTING RATE, AND PLANTING DATE FOR PERMANENT COVER 1**

Species	Broadcast Rates	Resource Area <sup>3</sup>	Planting Dates by Resource Area												Remarks	
			Solid lines indicate optimum dates, dotted lines indicate permissible but marginal dates													
	Pure Live Seed (PLS) Rate Per Acre <sup>4</sup> Per 1000 seed		J	F	M	A	M	J	J	A	S	O	N	D		
LESPEDEZA Ambro virgata Lespedeza virgata DC or Appalow Lespedeza cuneata (Dumont) G. Don)																
scarified	80 lbs 1.4 lb	M-L P C														300,000 seed per pound. Height of growth is 18 to 24 inches. Achromogous in urban areas. Spreading-type growth. New growth has bronze coloration. Mix with weeping lovegrass, common bermuda, bahia, tall fescue or winter annuals. Do not mix with Sericea lespedeza. Slow to develop solid stands. Inoculate seed with EL inoculant.
unscarified	75 lbs 1.7 lb	M-L P C														
LESPEDEZA, SHRUB Lespedeza bicolor Lespedeza thumbergii																
plants	3' x 3'	M-L P C														Provide mid-life food and cover.
LOVEGRASS, WEEPING Eragrostis curvula																
alone	4 lbs 0.1 lb	M-L P C														1,500,000 seed per pound. Quick cover. Drought tolerant. Grows well with Sericea lespedeza on roadbanks.
with other perennials	2 lbs 0.05 lb															

Table 8-6.2- Permanent Cover Crops

PLANT, PLANTING RATE, AND PLANTING DATE FOR PERMANENT COVER 1

Species	Broadcast Rates	Resource Area <sup>3</sup>	Planting Dates by Resource Area												Remarks
			Soiler lines indicate optimum dates, dotted lines indicate permissible but marginal dates												
	Pure Live Seed (PLS) Rate Per Acre <sup>2</sup> Per 1000 sqft		J	F	M	A	M	J	J	A	S	O	N	D	
MAIDENCANE <i>Panicum hemitomon</i>															
<b>SPRINGS</b>	<b>2' x 3' spacing</b>	<b>ALL</b>													For very wet sites. May clog channels. Dig springs from local sources. Use along river banks and shorelines.
PANICGRASS, ATLANTIC COASTAL <i>Panicum amarum var amarulum</i>															
	20 lbs	0.5 lb													Grows well on coastal sand dunes, brome areas, and gravel pits. Provides winter cover for wildlife. Mix with <i>Sericea lespedeza</i> except on sand dunes.
REED CANARY GRASS <i>Phalaris arundinacea</i>															
<b>alone</b>	50 lbs	1.1 lb													
<b>with other perennials</b>	30 lbs	0.7 lb													Grows similar to Tall fescue
SUNFLOWER, 'AZTEC' MAXIMILLIAN <i>Helianthus maximiliani</i>															
	10 lbs	0.2 lb													227,000 seed per pound. Mix with Weeping lovegrass or other low-growing grasses or legumes.

1 Reduce seeding rates by 50% when drilled  
 2 PLS is an abbreviation for Pure Live Seed. Refer to Section V.E. of these specifications.  
 3 M-L represents to Mountain, Blue Ridge, and Ridges and Valleys MLRAs  
 P represents the Southern Piedmont MLRA  
 C represents the Southern Coastal Plain; Sand Hills; Black Lands; and Atlantic Coast Flatwoods MLRAs. See Figure 6-4.1



Table 6-5.3.

## Durable Shrubs and Ground Covers for Permanent Cover

Ground covers include a wide range of low-growing plants planted together in considerable numbers to cover large areas of the landscape. Ground covers grow slower than grasses. Weeds are likely to compete, especially the first year. Maintenance is needed to insure survival. These ground covers will not be used unless proper maintenance is planned. Maintain mulch at three-inch thickness until plants provide adequate cover.

Fall planting is encouraged because the need for constant watering is reduced and plants have time to establish new roots before hot weather.

Common Name	Scientific Name	Mature Height	Plant Spacing	Comments
Abelia	<i>Abelia grandiflora</i>	3-4 ft.	5 ft.	Also a prostrate form 2 feet high. Sun, semi-shade. Semi-evergreen.
Carolina Yellow Jessamine	<i>Gelsemium sempervirens</i>	low	3 ft.	Vine. Yellow, trumpet-like flowers. Hardy, one of best vines. Evergreen. Native to Georgia.
Carpet Blue	<i>Ajuga reptans</i>	2-4 in.	3 ft.	Needs good drainage, partial shade. Blue or white flowers. Evergreen.
Bearberry Cotoneaster	<i>Cotoneaster dammeri</i>	2-4 ft.	5 ft.	White flowers, red fruit. Sun. Evergreen.
Ground Cover Cotoneaster	<i>Cotoneaster salicifolius</i> 'Repens'	1-2 ft.	5 ft.	White flowers, red fruit. Sun. Evergreen.
Rock Cotoneaster	<i>Cotoneaster horizontalis</i>	1-2 ft.	5 ft.	Semi-evergreen. Sun.
Virginia Creeper	<i>Parthenocissus quinquefolia</i>	low	3 ft.	Red in fall. Vine. Deciduous. Native to Georgia.
Daylily	<i>Hemerocallis</i> spp.	2-3 ft.	2 ft.	Many flower colors. Full sun. Very hardy.
English Ivy	<i>Hedera helix</i>	low	3 ft.	Shade only. Climbs.
Compacta Holly	<i>Ilex crenata</i> 'Compacta'	3-4 ft.	5 ft.	Sun, semi-shade.
Chinese Holly	<i>Ilex cornuta</i> 'Rotunda'	3-4 ft.	5 ft.	Very durable. Sun, semi-shade.
Dwarf Burford Holly	<i>Ilex burfordii</i> 'Nana'	5-8 ft.	8 ft.	
Dwarf Yaupon Holly	<i>Ilex vomitoria</i> 'Nana'	3-4 ft.	5 ft.	Very durable, sun, semi-shade.

Table 6-5.3. Durable Shrubs and Ground Covers for Permanent Cover

Common Name	Scientific Name	Mature Height	Plant Spacing	Comments
Repandens Holly	<i>Ilex crenata</i> 'Repandens'	2-3 ft.	5 ft.	Sun, semi-shade.
Andorra Juniper	<i>Juniperus</i> <i>horizontalis</i> 'Plumosa'	2-3 ft.	5 ft.	Excellent for slopes. Sun.
Andorra Compacta Juniper	<i>Juniperus</i> <i>horizontalis</i> 'Plumosa com- pacta'	1-2 ft.	5 ft.	More compact than andorra.
Blue Chip Juniper	<i>Juniperus</i> <i>horizontalis</i> 'Blue Chip'	8-10 in.	4 ft.	
Blue Rug Juniper	<i>Juniperus</i> <i>horizontalis</i> 'Wiltonii'	4-6 in.	3 ft.	Very low. Sun.
Parsons Juniper	<i>Juniperus</i> <i>deurica</i> 'Expansa' ( <i>Squamata</i> <i>Parsoni</i> )	18-24 in.	5 ft.	One of the best, good winter cover.
Pfitzer Juniper	<i>Juniperus</i> <i>chinensis</i> 'Pfitzerana'	6-8 ft.	6 ft.	Needs room.
Prince of Wales Juniper	<i>Juniperus</i> <i>horizontalis</i> 'Prince of Wales'	8-10 in.	4 ft.	Feathery appearance.
Sargent Juniper	<i>Juniperus</i> <i>chinensis</i> 'Sargentii'	1-2 ft.	5 ft.	Full sun. Needs good drainage. Good winter color.
Shore Juniper	<i>Juniperus conferta</i>	2-3 ft.	5 ft.	Emerald Sea or Blue Pacific cultivars are good.
Liriope	<i>Liriope muscari</i>	8-10 in.	3 ft.	

Table 6-5.3. Durable Shrubs and Ground Covers for Permanent Cover

<b>Common Name</b>	<b>Scientific Name</b>	<b>Mature Height</b>	<b>Plant Spacing</b>	<b>Comments</b>
<b>Creeping Liriope</b>	<i>Liriope spicata</i>	10-12 in.	1 ft.	Spreads by runners.
<b>Big Leaf Periwinkle</b>	<i>Vinca major</i>	12-15 in.	4 ft.	Lilac flowers in spring. Semi-shade.
<b>Common Periwinkle</b>	<i>Vinca minor</i>	5-6 in.	4 ft.	Lavender-blue flowers in spring. Semi-shade
<b>Cherokee Rose</b>	<i>Rosa laevigata</i>	2 ft.	5 ft.	Rampant grower. Not for restricted spaces. State flower.
<b>Memoria Rose</b>	<i>Rosa wichuriana</i>	2 ft.	5 ft.	Rampant grower.
<b>St. Johnswort</b>	<i>Hypericum calycinum</i>	8-12 in.	3 ft.	Semi-shade.
<b>Anthony Waterer Spirea</b>	<i>Spiraea bumalda</i>	3-4 ft.	5 ft.	Sun.
<b>Thunberg Spirea</b>	<i>Spiraea thunbergii</i>	3-4 ft.	5 ft.	Sun.

**Table 6-5.4.**

**Trees for Erosion Control**

SITE	SOIL MATERIAL	COMMON SOILS	PLANTING TREE SPECIES <sup>1</sup>	SPACING	PLANTING DATES <sup>3</sup>
Borrow areas, graded areas, and spoil material	Sandy	Lakeland, Troup	Loblolly pine (Pinus taeda)  Longleaf pine (Pinus palustris)	<sup>2</sup>	M-L,P 12/1-3/15 C 12/1-3/1
	Loamy	Orangeburg, Tifton	Loblolly pine Slash pine Loblolly pine	<sup>2</sup>	M-L,P 12/1-3/15 C 12/1-3/1
	Clay	Cecil, Faceville	Slash pine  Virginia pine (Pinus virginiana)	<sup>2</sup>	M-L,P 12/1-3/15 C 12/1-3/1
Streambanks			Willows <sup>4</sup> (Salix species)	2 ft x 2 ft	ALL

<sup>1</sup> Other trees and shrubs listed on Table 6-25.3 may be interplanted with the pines for improved wildlife benefits.

<sup>2</sup> Type of Planting	Tree Spacing	No. of Trees Per Acre
Trees alone	4 ft. x 4 ft.	2722
Trees in combination with grasses and/or other plants	6 ft. x 6 ft.	1210

<sup>3</sup> M-L represents the Mountains; Blue Ridge; and Ridges and Valleys MLRAs  
P represents the Southern Piedmont MLRA  
C represents the Southern Coastal Plain; Sand Hills; Black Lands; and Atlantic Coast Flatwoods MLRAs (See Figure 6-4.1).

<sup>4</sup> Fertilization of companion crop is ample for this species.

# DISTURBED AREA STABILIZATION (WITH SODDING)

Ds4



## DEFINITION

A permanent vegetative cover using sods on highly erodible or critically eroded lands.

## PURPOSE

- Establish immediate ground cover.
- Reduce runoff and erosion.
- Improve aesthetics and land value.
- Reduce dust and sediments.
- Stabilize waterways, critical areas.
- Filter sediments, nutrients and bugs.
- Reduce downstream complaints.
- Reduce likelihood of legal action.
- Reduce likelihood of work stoppage due to legal action.
- Increase “good neighbor” benefits.

## CONDITIONS

This application is appropriate for areas that require immediate vegetative covers, drop inlets, grass swales, and waterways with intermittent flow.

## PLANNING CONSIDERATIONS

Sodding can initially be more costly than seeding, but the advantages justify the increased initial costs:

1. Immediate erosion control, green surface, and quick use.
2. Reduced failure as compared to seed as well as the lack of weeds.
3. Can be established nearly year-round.

Sodding is preferable to seed in waterways and swales because of the immediate protection of the channel after application. Sodding must be staked in concentrated flow areas (See Figure 6-6.1).

Consider using sod framed around drop inlets to reduce sediments and maintaining the grade.

## CONSTRUCTION SPECIFICATIONS

### Soil Preparation

Bring soil surface to final grade. Clear surface of trash, woody debris, stones and clods larger than 1”. Apply sod to soil surfaces only and not frozen surfaces, or gravel type soils.

Topsoil properly applied will help guarantee a stand. Don’t use topsoil recently treated with herbicides or soil sterilants.

**Mix fertilizer into soil surface. Fertilize based on soil tests or Table 6-6.1.**

Table 6-6.1. Fertilizer Requirements for Soil Surface Application			
Fertilizer Type	Fertilizer Rate (lbs/acre)	Fertilizer Rate (lbs/sq ft)	Season
10-10-10	1000	.025	Fall

**Agricultural lime should be applied based on soil tests or at a rate of 1 to 2 tons per acre.**

### Installation

Lay sod with tight joints and in straight lines. Don’t overlap joints. Stagger joints and do not stretch sod (See Figure 6-6.2)

On slopes steeper than 3:1, sod should be anchored with pins or other approved methods. Installed sod should be rolled or tamped to provide good contact between sod and soil.

Irrigate sod and soil to a depth of 4" immediately after installation.

Sod should not be cut or spread in extremely wet or dry weather. Irrigation should be used to supplement rainfall for a minimum of 2-3 weeks.

**MATERIALS**

Sod selected should be certified. Sod grown in the general area of the project is desirable.

1. Sod should be machine cut and contain 3/4" (+ or -1/4") of soil, not including shoots or thatch.
2. Sod should be cut to the desired size within + or -5%. Torn or uneven pads should be rejected.
3. Sod should be cut and installed within 36 hours of digging.
4. Avoid planting when subject to frost heave or hot weather, if irrigation is not available.
5. The sod type should be shown on the plans or installed according to Table 6-6.2. See Figure 6-4.1 for your Resource Area.

Grass	Varieties	Resource Area	Growing Season
Bermudagrass	Common Tifway Tifgreen Tiflawn	M-L,P,C P,C P,C P,C	warm weather
Bahiagrass	Pensacola	P,C	warm weather
Centipede	-	P,C	warm weather
St. Augustine	Common Bitterblue Raleigh	C	warm weather
Zoysia	Emerald Myer	P,C	warm weather
Tall Fescue	Kentucky	M-L,P	cool weather

**MAINTENANCE**

Re-sod areas where an adequate stand of sod is not obtained. New sod should be mowed sparingly. Grass height should not be cut less than 2"-3" or as specified (See Figure 6-6.2).

Apply one ton of agricultural lime as indicated by soil test or every 4-6 years. Fertilize grasses in accordance with soil tests or Table 6-6.3.

Types of Species	Planting Year	Fertilizer (N-P-K)	Rate (lbs./acre)	Nitrogen Top Dressing Rate (lbs./acre)
cool season grasses	first	6-12-12	1500	50-100
	second	6-12-12	1000	-
	maintenance	10-10-10	400	30
warm season grasses	first	6-12-12	1500	50-100
	second	6-12-12	800	50-100
	maintenance	10-10-10	400	30

# SODDED WATERWAYS

## SOD DIRECTIONS

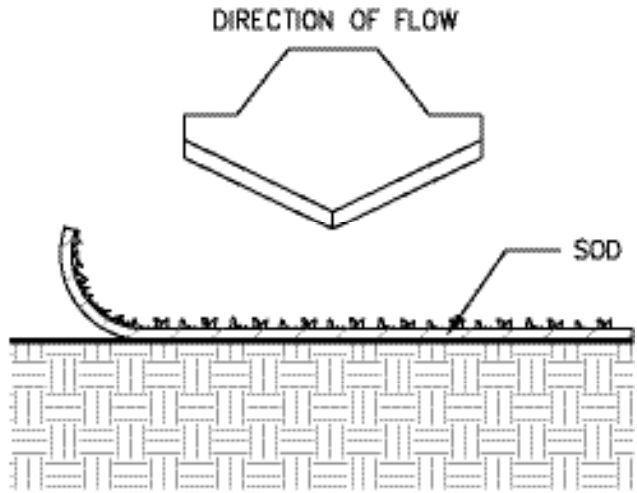
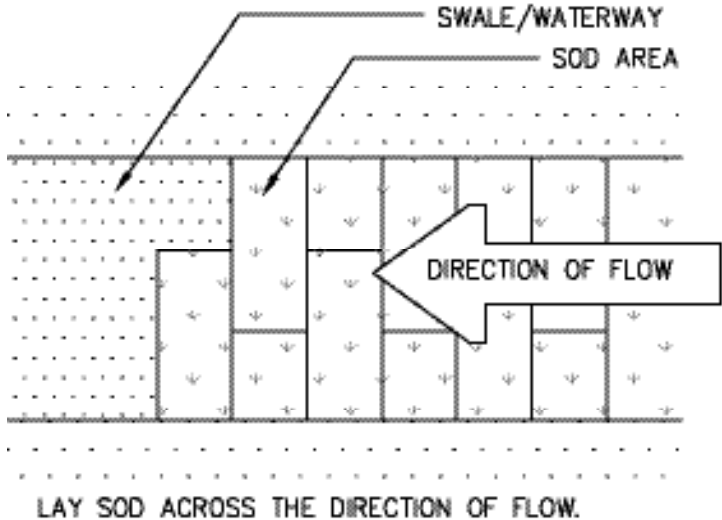

## NETTING DIRECTIONS

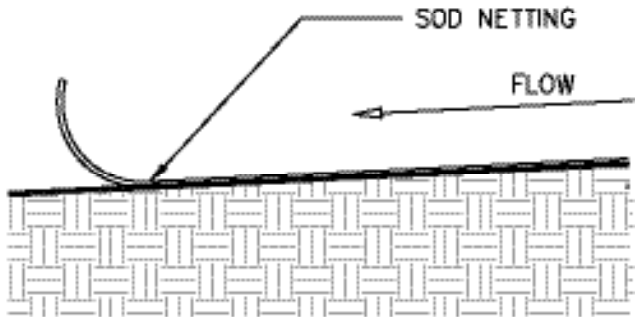
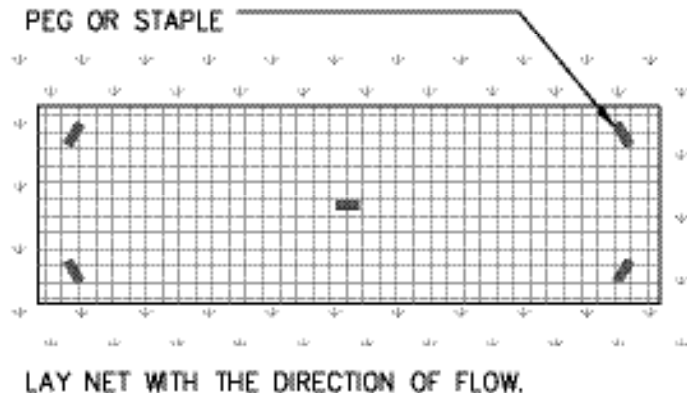

## PEG DETAIL

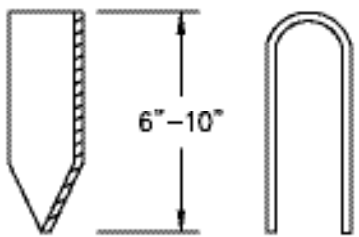

IN CRITICAL AREAS, SECURE SOD WITH NETTING USING STAPLES.

USE PEGS OR STAPLES TO FASTEN SOD FIRMLY -- AT THE ENDS OF STRIPS AND IN THE CENTER, OR EVERY 3–4 FEET IF THE STRIPS ARE LONG. WHEN READY TO MOW, DRIVE PEGS OR STAPLES FLUSH WITH THE GROUND.

Source: Va. DSWC

Figure 6-6.1

# SOD MAINTENANCE AND INSTALLATION

## SOD LAYOUT AND PREPARATION

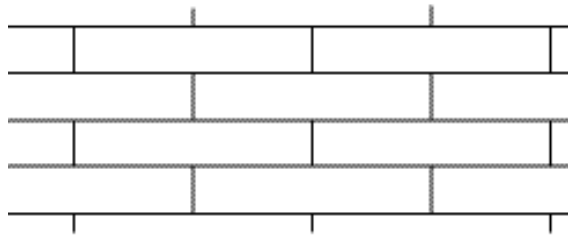

LAY SOD IN A STAGGERED PATTERN. BUTT THE STRIPS TIGHTLY AGAINST EACH OTHER. DO NOT LEAVE SPACES AND DO NOT OVERLAP. A SHARPENED MASON'S TROWEL IS A HANDY TOOL FOR TUCKING DOWN THE ENDS AND TRIMMING PIECES.

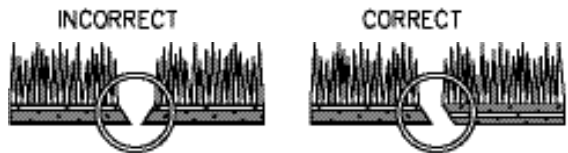

**BUTTING:** ANGLED ENDS CAUSED BY THE AUTOMATIC SOD CUTTER MUST BE MATCHED CORRECTLY.

## DIRECTIONS FOR INITIAL MAINTENANCE

- Step 1. ROLL SOD IMMEDIATELY TO ACHIEVE FIRM CONTACT WITH THE SOIL.
- Step 2. WATER TO A DEPTH OF 4" AS NEEDED. WATER WELL AS SOON AS THE SOD IS LAID.
- Step 3. MOW WHEN THE SOD IS ESTABLISHED -- IN 2-3 WEEKS. SET THE MOWER HIGH (2"-3").

## APPEARANCE OF GOOD SOD

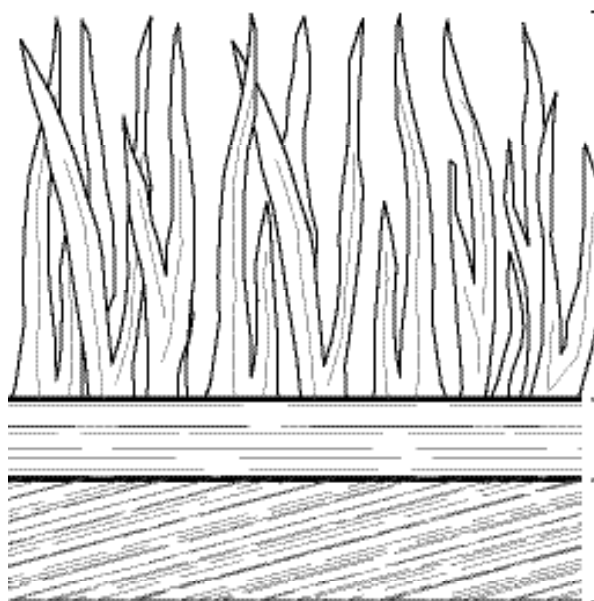

**SHOOTS OR GRASS BLADES:** GRASS SHOULD BE GREEN AND HEALTHY, MOWED AT A 2"-3" CUTTING HEIGHT.

**THATCH:** GRASS CLIPPINGS AND DEAD LEAVES (UP TO 1/2" THICK).

**ROOT ZONE:** SOIL AND ROOTS. SHOULD BE 1/2"-3/4" THICK WITH DENSE ROOT MAT FOR STRENGTH.

Source: Va. DSWC

Figure 6-6.2



# Dust Control on Disturbed Areas

Du



## DEFINITION

Controlling surface and air movement of dust on construction sites, roads, and demolition sites.

## PURPOSE

- To prevent surface and air movement of dust from exposed soil surfaces.
- To reduce the presence of airborne substances that may be harmful or injurious to human health, welfare, or safety, or to animals or plant life.

## CONDITIONS

This practice is applicable to areas subject to surface and air movement of dust where on and off-site damage may occur without treatment.

## METHOD AND MATERIALS

### A. Temporary Methods

**Mulches.** See standard **Ds1 - Disturbed Area Stabilization (With Mulching Only)**. Synthetic resins may be used instead of asphalt to bind mulch material. Refer to specification **Tac - Tackifiers**. Resins should be used according to manufacturer's recommendations.

**Vegetative Cover.** See specification **Ds2 - Disturbed Area Stabilization (With Temporary Seeding)**.

**Spray-on Adhesives.** These are used on mineral soils (not effective on muck soils). Keep traffic off these areas. Refer to specification **Tac - Tackifiers**.

**Tillage.** This practice is designed to roughen and bring clods to the surface. It is an emergency

measure that should be used before wind erosion starts. Begin plowing on windward side of site. Chisel-type plows spaced about 12 inches apart, spring-toothed harrows, and similar plows are examples of equipment that may produce the desired effect.

**Irrigation.** This is generally done as an emergency treatment. Site is sprinkled with water until the surface is wet. Repeat as needed.

**Barriers.** Solid board fences, snowfences, burlap fences, crate walls, bales of hay and similar material can be used to control air currents and soil blowing. Barriers placed at right angles to prevailing currents at intervals of about 15 times their height are effective in controlling wind erosion.

**Calcium Chloride.** Apply at rate that will keep surface moist. May need retreatment.

### B. Permanent Methods

**Permanent Vegetation.** See specification **Ds3 -Disturbed Area Stabilization (With Permanent Vegetation)**. Existing trees and large shrubs may afford valuable protection if left in place.

**Topsoiling.** This entails covering the surface with less erosive soil material. See specification **Tp - Topsoiling**.

**Stone.** Cover surface with crushed stone or coarse gravel. See specification **Cr-Construction Road Stabilization**.



# Flocculants Coagulants

FI-Co

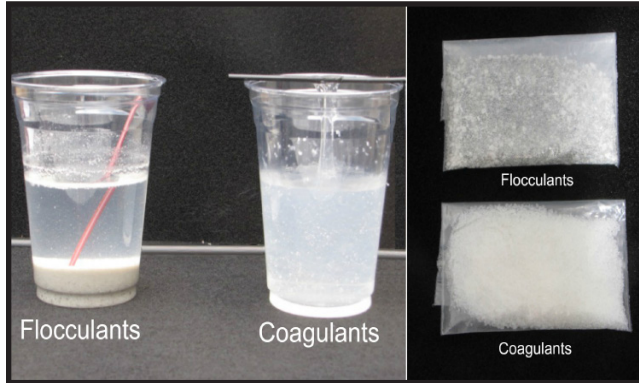

## DEFINITION

Flocculants and Coagulants (FI-Co) are formulated to assist in the solids/liquid separation of suspended particles in solution. Such particles are characteristically very small and the suspended stability of such particles (colloidal complex) is due to both their small size and to the electrical charge between particles. Conditioning a solution to promote the removal of suspended particles requires chemical coagulation and/or flocculation.

A coagulant is required to help give body to the water. Coagulants neutralize the repulsive electrical charges (typically negative) surrounding particles allowing them to “stick together” creating clumps or flocs that form a small to mid-size particles (sometimes called a pin-floc). Once the pin-floc has formed, a second chemical called a flocculent is required to make even larger particles. Flocculants facilitate the agglomeration or aggregation of the coagulated particles to form larger flocules and acts as a net where it gathers up the smaller coagulated particles making a larger particle. This larger particle will slowly drop to the bottom of the container (vessel), forming a sludge.

Coagulation and Flocculation occur in successive order. Firstly the forces stabilizing suspended particles are neutralized allowing particles to meet (coagulate) and secondly, to form larger, heavier flocs (flocculants).

## PURPOSE

To settle suspended sediment, heavy metals and hydrocarbons (TSS) in runoff water from

construction sites for water clarification.

## CONDITIONS

Water clarification and the removal of turbidity will usually require the addition of flocculants, polymers, polyacrylamides (PAM), chitosan and other chemicals that cause soil particles to bind together, become heavy and settle to the bottom of a sediment trap, sediment basin or become entrapped in other BMPs.

This practice is not intended for application to surface waters of the state. It is intended for application within construction storm water ditches and storm drainages that feed into pre-constructed ponds or basins or other BMPs.

## Federal and Local Laws

FI-Co applications shall comply with all federal, local laws, rules or regulations governing FI-Co. The operator is responsible for securing applicable required permits, if needed. This standard does not contain the text of the federal or local laws governing Flocculants/Coagulants.

## Planning Considerations

Since settling of flocculated soil particles requires very slow moving (still) water, chemical additives should never be introduced into an outfall BMP where water leaves the property or enters state waters. In all cases where chemical additives are used to reduce turbidity, it is essential to include a sediment basin or sediment trap unless using a “pump and treat” treatment system.

## CRITERIA

Application rates shall conform to manufacturer’s guidelines for application. Only anionic forms of FI-Co shall be used.

Following are examples of FI-Co applications within construction storm water ditches or drainageways that feed into sediment basins or other BMPs:

- FI-Co Bags or Socs that are installed directly in a ditch, pipe or culvert.
- FI-Co treated ditch checks (i.e. fiber rolls, wattles, or compost logs inoculated or used in conjunction with FI-Co ).
- Granulated FI-Co treated rock ditch checks.

- Ditch checks with attached FI-Co Bags or Socs.
- Addition of granular FI-Co directly into a ditch.
- Erosion control blankets and turf reinforcement mats that have been inoculated with a FI-Co .
- “Pump and Treat” systems that use mechanical mixing with a chemical treatment of a FI-Co.

### **Operation and Maintenance**

Application rates shall conform to manufacturer’s guidelines for application. Maintenance shall consist of reapplying FI-Co via one of means above when turbidity levels are no longer met or the FI-Co is used up. Bricks, blocks, socks,logs and bags shall be maintained when sediment sediment accumulates on the products.

# STREAMBANK STABILIZATION

(USING PERMANENT VEGETATION)

Sb



## DEFINITION

The use of readily available native plant materials to maintain and enhance streambanks, or to prevent, or restore and repair small streambank erosion problems.

## PURPOSE

- Lessen the impact of rain directly on the soil.
- Trap sediment from adjacent land.
- Form a root mat to stabilize and reinforce the soil on the streambank.
- Provide wildlife habitat.
- Enhance the appearance of the stream.
- Lower summertime water temperatures for a healthy aquatic population.

**NOTE:** Careful thought, planning and execution is required to assure that the streambank stabilization project is done efficiently and correctly. Please refer to the GSWCC’s guidance document, *STREAMBANK AND SHORELINE STABILIZATION*.

## Preferred Practices:

### Live Staking

Live stakes are living, woody plant cuttings capable of rooted when inserted into the banks. These stakes, commonly willow species, can root and grow into shrubs that overtime will stabilize the streambank or shoreline and provide riparian habitat.

### Live Fascines

Live fascines are bound bundles of live branch cuttings that are buried onto the bank and staked into place along the slope contour. Willow branches are the most commonly used for this method.

### Branchpacking

Branchpacking is the process of incorporating alternating layers of live branch cuttings and compacted soils into a hole, gully or slump. This method is used to fill in depressions along the streambank or shoreline.

### Vegetated Geogrid

Vegetated geogrids are similar to branchpacking except that natural or synthetic geotextile materials are wrapped around each soil lift between the layers of live branch cuttings.

### Brushmattress

A brushmattress system consists of live branch cuttings, live stakes, and live fascines installed to cover and stabilize the entire streambank/shoreline and secured in place. This method is installed above the normal stream flow and provides immediate protective coverage of the bank.

### Coconut Fiber Roll

A coconut fiber roll is a flexible “log” made from coconut hull fibers, staked at the toe of the bank. The technique is often used in conjunction with native plants to trap sediment and encourage plant growth.

### Dormant Post Plantings (Live Posts)

Dormant post plantings form a permeable revetment that is constructed from rootable vegetative material placed along streambanks in a square or triangular pattern.

## Acceptable Practices

### Joint Planting

Joint planting or vegetated riprap involves tamping live stakes into joints or open spaces in rocks that have been placed on a slope. Vegetation, especially deep rooting species, planted above and immediately behind the rock will greatly increase the stability of the slope

### Live Cribwall

A live cribwall is a box-like structure with a

framework of logs or timbers, rock and live cuttings that can protect eroding streambanks or shorelines. Once live cuttings become established, mature vegetation gradually takes over the structural functions of the logs or timbers.

also tend to reflect wave energy rather than dissipate it, usually resulting in erosion problems in front of the “fix” and elsewhere.

### **Vegetated Gabion Baskets**

Gabion baskets are rectangular containers fabricated from a heavily galvanized steel wire or riple twisted hexagonal mesh. These empty gabions are placed in position, wired to adjoining gabions, filled with stones, and then wired shut. Vegetation is incorporated into rock gabions by placing live branches on each consecutive layer between the rock filled baskets.

### **Tree Revetments**

Tree revetments are rows of cut trees anchored to the toe of the bank. This is a low cost method, often used for toe protection with other bioengineering techniques.

### **Log Rootwad and Boulder Revetments**

These revetments are systems composed of logs, rootwads, and boulders selectively placed in and on streambanks.

### **Discouraged Practices**

#### **Rock Riprap**

Riprap stabilization designs should include appropriate bank slope and rock size to protect the bank from wave and current action and to prolong the life of the embankment. A final slope ratio of at least 1:2 (vertical to horizontal) is recommended, and a more stable 1:3 slope should be used where possible.

A layer of gravel, small stone, or filter cloth placed under and/or behind the rock helps prevent failure. In many cases, only the toe of the slope may need rock reinforcement; the remainder can be planted with native vegetation.

#### **Rock Gabions**

Rock gabions with vegetation are a more acceptable stabilization practice.

#### **Bulkheads and Seawalls**

Bulkheads and seawalls are not encouraged and generally are not approved. These structures (typically sheet steel, concrete or wood) produce a sterile, vertical, flat-faced object that is of little use to aquatic organisms and other wildlife. They

**Table 6-9.1  
Streambank Erosion Protection Measures Relative Costs and Complexity**

<b>Measure</b>	<b>Relative Cost</b>	<b>Relative Complexity</b>
Live Stake	Low	Simple
Joint Planting	Low*	Simple*
Live Fascine	Moderate	Moderate
Bushmatress	Moderate	Moderate to Complex
Live Cribwall	High	Complex
Branchpacking	Moderate	Moderate to Complex
Conventional Vegetation	Low to Moderate	Simple to Moderate
Converntional bank amoring (rip rap)	Moderate to High	Moderate to Complex

\*Assumes rock is in place

# STREAM STABILIZATION

## LIVE STAKING CROSS-SECTION

NOTES:

ROOTED/LEAFED CONDITION OF THE LIVING PLANT MATERIAL IS NOT REPRESENTATIVE AT THE TIME OF INSTALLATION.

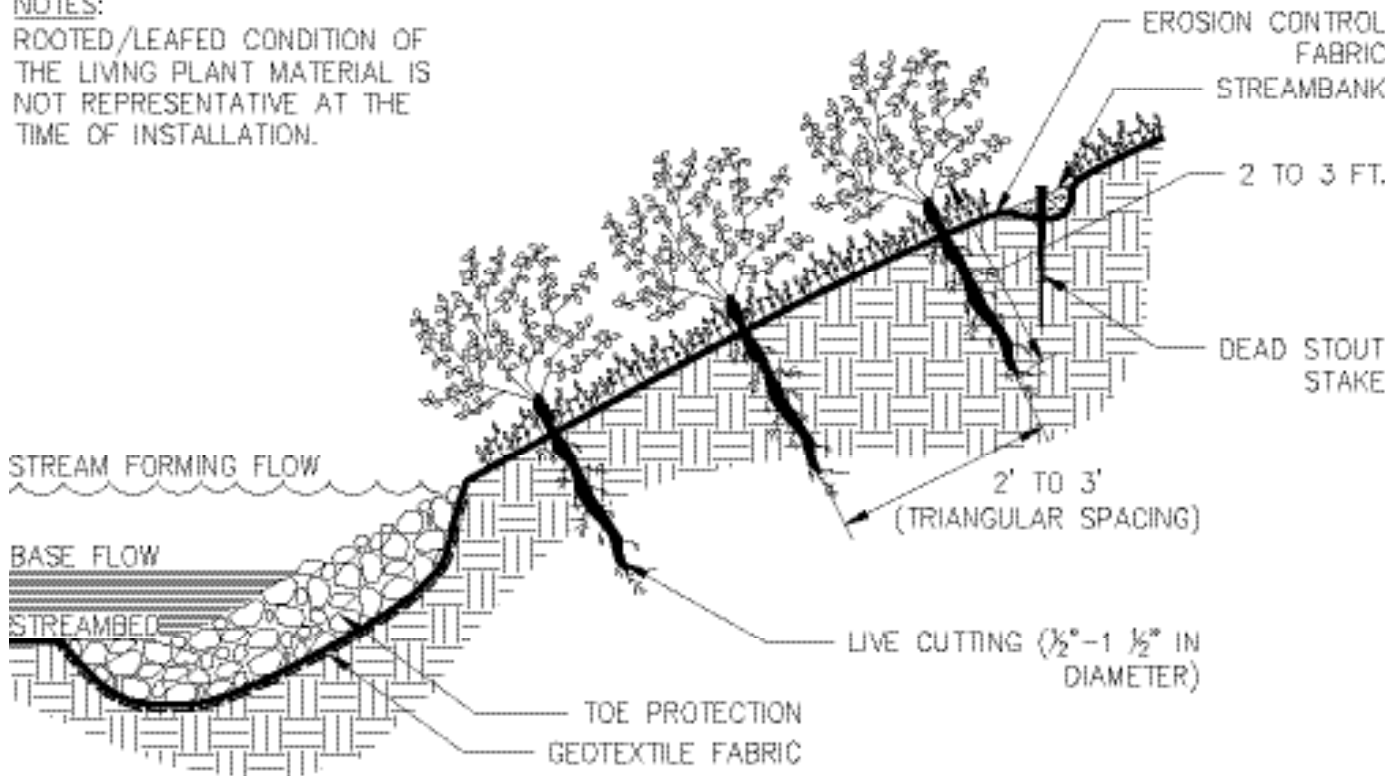

Figure 6-9.1 Illustration of a Live Stake



# STREAMBANK STABILIZATION

## FASCINE BUNDLE DETAIL



## LIVE FASCINE CROSS-SECTION DETAIL

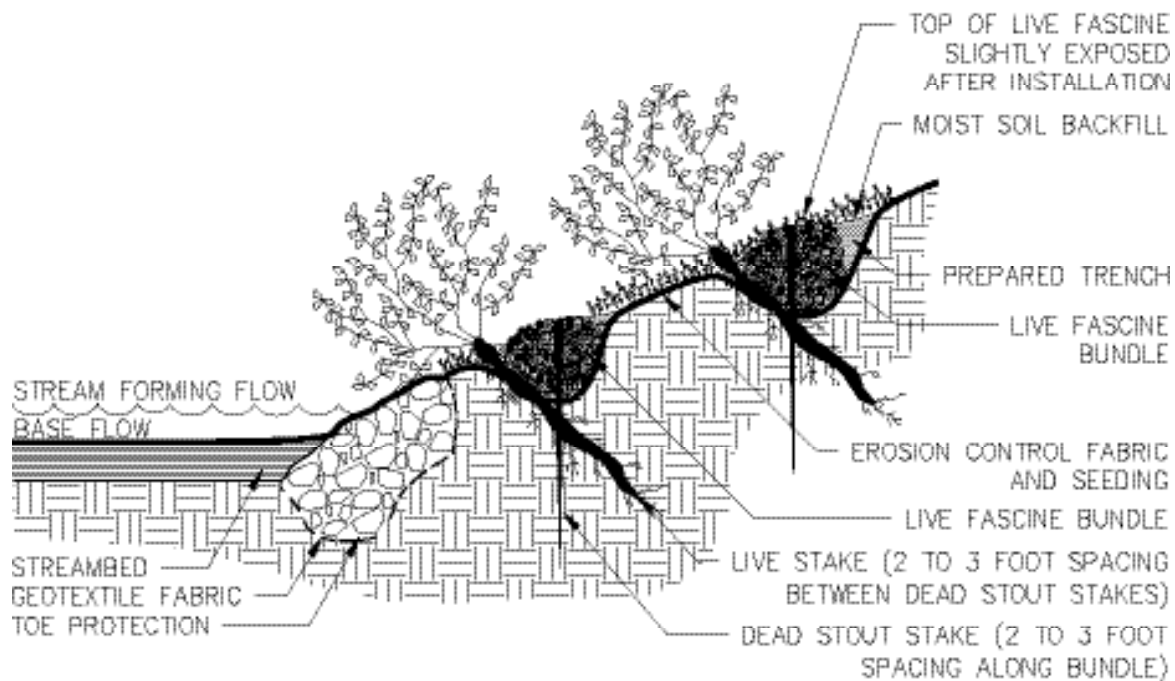

### NOTES:

1. ROOTED/LEAFED CONDITION OF THE LIVING PLANT MATERIAL IS NOT REPRESENTATIVE OF THE TIME OF INSTALLATION.
2. LIVE FASCINES SHALL BE PREPARED FROM FRESHLY CUT DORMANT PLANTS AND INSTALLED WITHIN 8 HOURS OF THE TIME THE MATERIAL IS HARVESTED, UNLESS PROPERLY STORED.
3. LIVE FASCINE SHALL BE OBTAINED FROM SOURCES APPROVED BY ENGINEER.
4. LIVE FASCINES SHALL BE 4"-8" IN DIAMETER WITH MINIMUM 8' LENGTH.
5. BEGINNING AT THE BASE OF THE SLOPE, A TRENCH SHALL BE DUG LARGE ENOUGH TO CONTAIN THE LIVE FASCINES. THE LIVE FASCINES SHALL BE PLACED IN THE TRENCH. WHERE ENDS MEET IN THE TRENCH, THE FASCINES SHALL OVERLAP BY 18".
6. THE TRENCH SHALL BE BACKFILLED WITH MOIST SOIL AND HAND TAMPED. THE TOP OF THE FASCINE SHALL BE SLIGHTLY EXPOSED WHEN THE INSTALLATION IS COMPLETE AS SHOWN ON CROSS SECTION.
7. SEED OR OTHER EROSION CONTROL MATERIAL SHALL BE USED BETWEEN THE FASCINE ROWS, AS SPECIFIED IN THE CONTRACT DOCUMENTS.
8. LIVE FASCINE TRENCHES SHALL BE FROM 3' TO 8' APART, ACCORDING TO SLOPE AND/OR CONTRACT DOCUMENTS.

Figure 6-9.2 Illustration of a Live Fascine

# STREAMBANK STABILIZATION

## BRANCHPACKING CROSS-SECTION

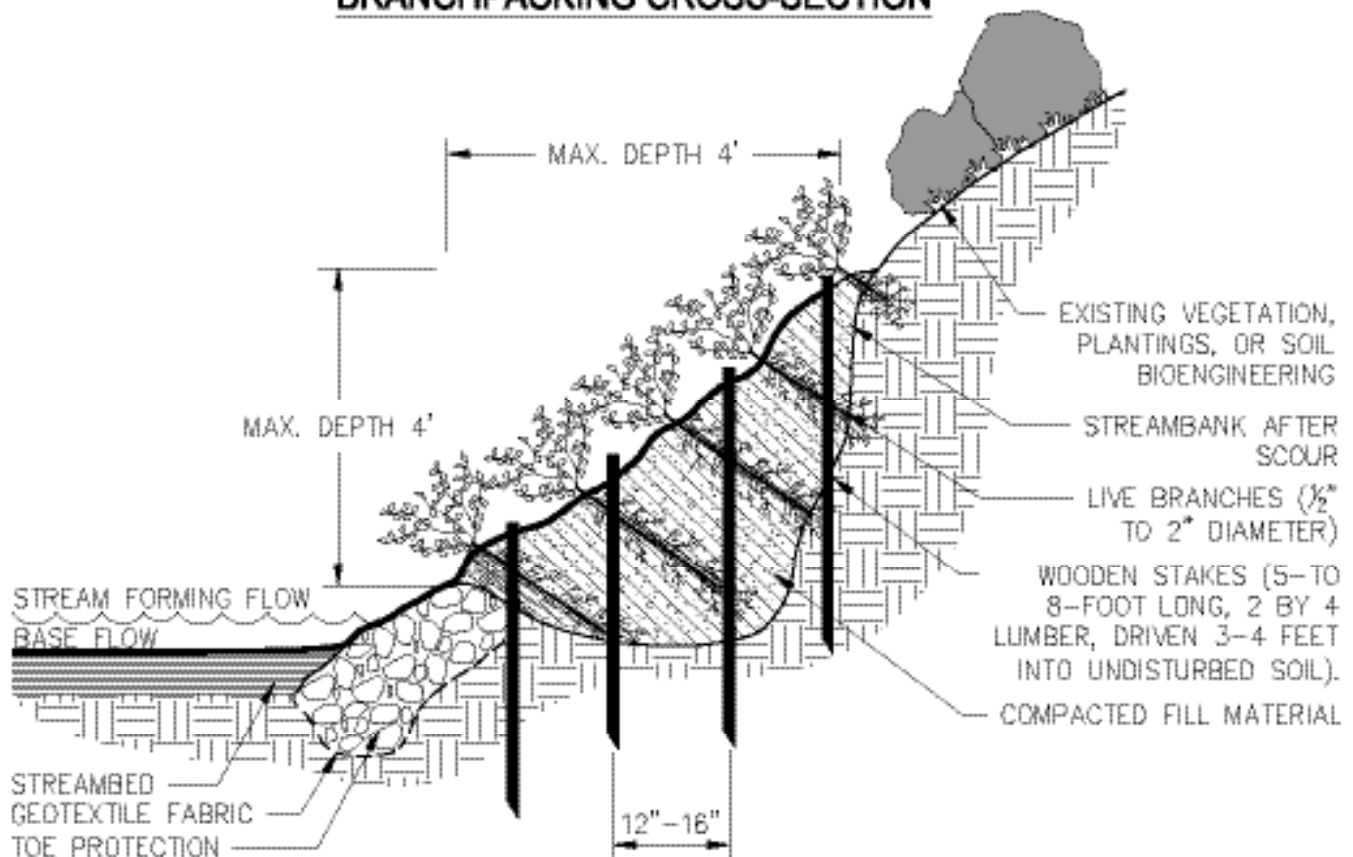

### NOTES:

1. ROOT/LEAFED CONDITION OF THE LIVING PLANT MATERIAL IS NOT REPRESENTATIVE OF THE TIME OF INSTALLATION.
2. STARTING AT THE LOWEST POINT, DRIVE THE WOODEN POSTS VERTICALLY 3' TO 4' INTO THE GROUND AND SET THEM 12"-16" APART.
3. A LAYER OF LIVING BRANCHES (4"-6" THICK) IS PLACED IN THE BOTTOM OF THE HOLE, BETWEEN THE VERTICAL POSTS. THEY SHALL BE PLACED IN A CRISSCROSS CONFIGURATION.
4. THE FINAL INSTALLATION SHALL MATCH THE EXISTING SLOPE. BRANCHES SHOULD PROTRUDE ONLY SLIGHTLY FROM THE FILLED FACE.
5. EACH LAYER OF BRANCHES SHALL BE FOLLOWED BY A 12" LAYER OF SOIL HAND TAMPED TO ENSURE CONTACT WITH THE BRANCH CUTTINGS.
6. THE SOIL SHALL BE MOIST OR MOISTENED TO ENSURE THAT LIVE BRANCHES DO NOT DRY OUT.
7. WHERE SPECIFIED, LIVE STAKES SHALL BE USED IN PLACE OF POSTS.

Figure 6-9.3 Illustration of a Branchpacking

# STREAMBANK STABILIZATION

## BRUSHMATTRESS CROSS-SECTION

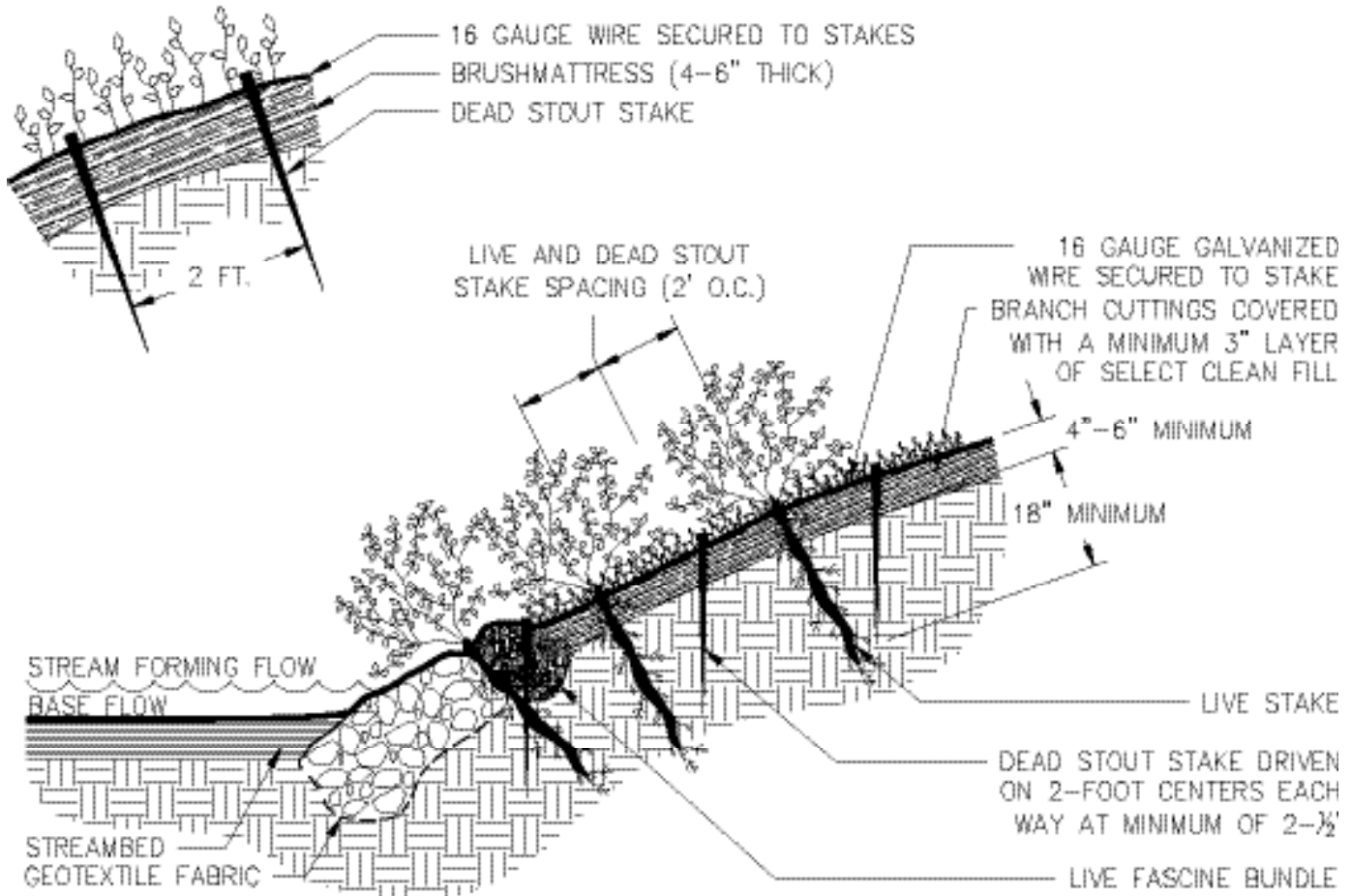

### NOTES:

1. ROOTED/LEAFED CONDITION OF THE LIVING PLANT MATERIAL IS NOT REPRESENTATIVE AT THE TIME OF INSTALLATION.
2. LAYERS SHALL BE COMPRISED OF LIVE QUICK-ROOTING SPECIES. SEE CONTRACT DOCUMENTS.
3. FILL MATTRESS WITH SOIL AND EVENLY DISTRIBUTE TO APPROXIMATELY 4" MIN. IN DEPTH AND HAND TAMP.
4. PLACE STAKES EVENLY OVER THE GRADED FACE USING 2' SQUARE SPACING. IF LIVE STAKES ARE SPECIFIED, ALTERNATE EVERY OTHER ONE WITH A DEAD STOUT STAKE.
5. STRETCH 16 GAUGE GALVANIZED WIRE DIAGONALLY FROM ONE STAKE TO ANOTHER BY TIGHTLY WRAPPING WIRE AROUND STAKES, NO CLOSER THAN 6" FROM THE TOP OF STAKE. WIRE SHALL NOT BE ATTACHED TO LIVE STAKES. POUND STAKES TO COMPRESS MATTRESS.
6. LIVE FASCINES AND LIVE STAKES ARE INSTALLED WHEN AND WHERE DIRECTED ON THE PLAN SHEET.

Figure 6-9.4 Illustration of a Brushmattress

# STREAM STABILIZATION

## JOINT PLANTING CROSS SECTION

**NOTES:**

ROOTED/LEAFED CONDITION OF THE LIVING PLANT MATERIAL IS NOT REPRESENTATIVE AT THE TIME OF INSTALLATION.

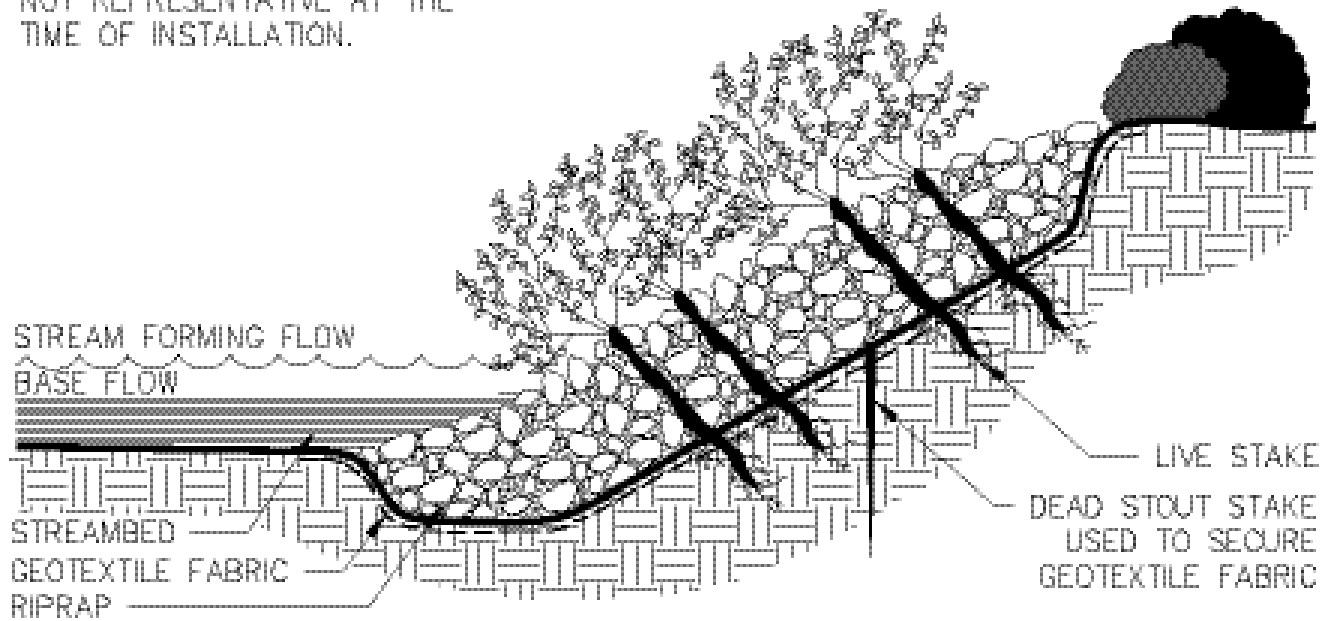
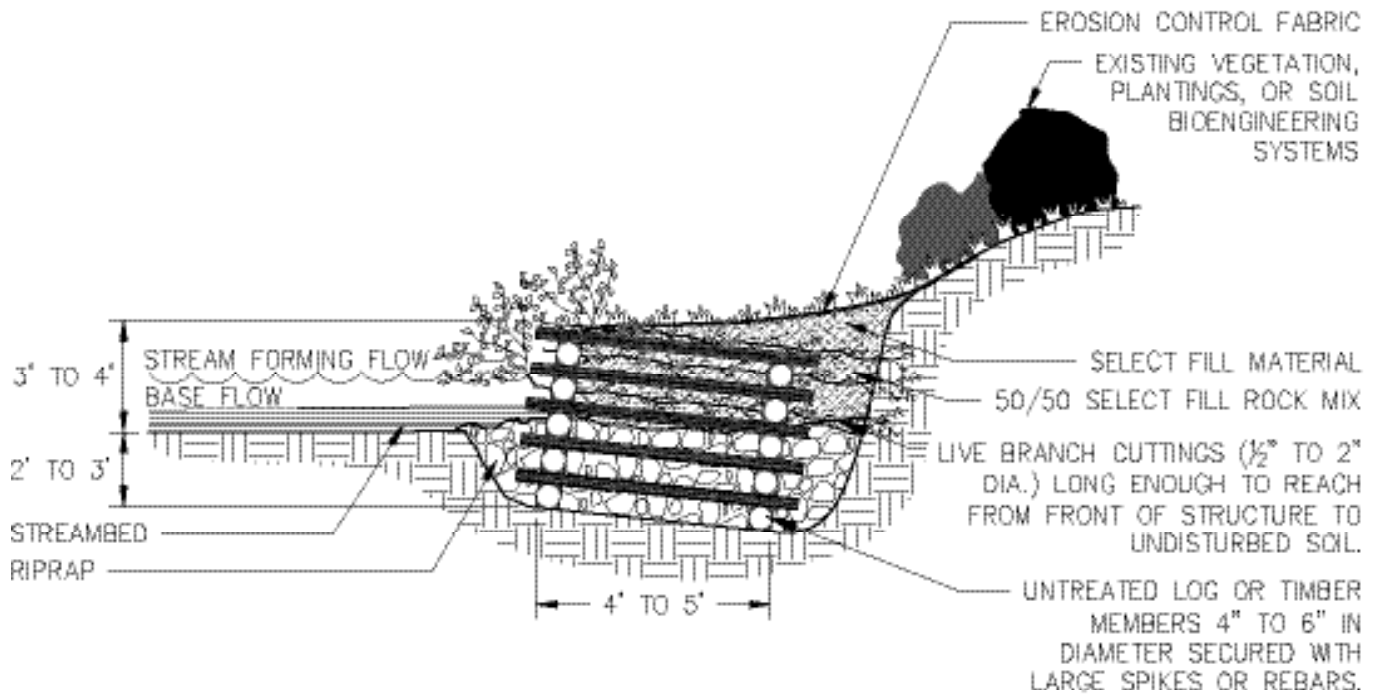

Figure 6-9.5 Illustration of Joint Planting

# STREAMBANK STABILIZATION

## LIVE CRIBWALL CROSS-SECTION



### NOTES:

1. ROOTED/LEAFED CONDITION OF THE LIVING PLANT MATERIAL IS NOT REPRESENTATIVE OF THE TIME OF INSTALLATION.
2. EACH COURSE SHALL BE SECURED TO THE PRECEDING COURSE WITH SPIKES OR REBARS (SIZE VARIES ACCORDING TO PROJECT).
3. BACKFILL IN AND AROUND TIMBER CRIB WITH RIPRAP FROM BOTTOM OF EXCAVATION TO THE LOWER GROUND LEVEL (OR WHEN IN STREAM CHANNEL UP TO BASEFLOW).
4. EACH TRANSVERSE LOG COURSE CONTAINS LIVE CUTTINGS FOLLOWED BY A LAYER OF TAMPED BACKFILL.
5. EACH FACE LOG COURSE (FRONT AND REAR), AND THE AREA BEHIND THE STRUCTURE SHALL BE BACKFILLED AND HAND TAMPED.

Figure 6-9.6 Illustration of a Live Cribwall



# Slope Stabilization

Ss



## DEFINITION

A protective covering used to prevent erosion and establish temporary or permanent vegetation on steep slopes, shore lines, or channels.

## PURPOSE

To provide a cover layer that stabilizes the soil and acts as a rain drop impact dissipater while providing a microclimate that protects young vegetation and promotes its establishment. If using slope stabilization to reinforce channels, please refer to specification, **Ch- Channel Stabilization**.

## CONDITIONS

Slope stabilization can be applied to flat areas or slopes where the erosion hazard is high and slope protection is needed during the establishment of vegetation.

## PLANNING CONSIDERATIONS

Care must be taken to choose the type of slope stabilization product that is most appropriate for the specific needs of a project. Two general types of slope stabilization products are discussed within this specification.

### Rolled Erosion Control Products (RECP)

A natural fiber blanket with single or double photodegradable or biodegradable nets.

### Hydraulic Erosion Control Products (HECP)

HECP shall utilize straw, cotton, wood or other natural based fibers held together by a soil binding agent that works to stabilize soil particles. Paper mulch should not be used for erosion control.

## CRITERIA

Rolled Erosion Control Products (RECPs) and Hydraulic Erosion Control Products (HECPs):

- Installation and stapling of RECPs and application rates for the HECPs shall conform to manufacturer's guidelines for application
- Short-Term RECPs as a minimum shall be used to stabilize concentrated flow areas with a velocity less than 5ft/sec on slopes 3:1 or greater with a height of 10 feet or greater.

## Materials – HECP

Hydraulic erosion control products shall be prepackaged from the manufacturer. Field mixing of performance enhancing additives will not be allowed. Fibrous components should be all natural or biodegradable.

Products shall be determined to be non-toxic in accordance with EPA-821-R-02-012.

## Materials – RECP

Blankets shall be nontoxic to vegetation, seed, or wildlife. Products shall be determined to be non-toxic in accordance with EPA-821-R-02-012. At minimum, the plastic or biodegradable netting shall be stitched to the fibrous matrix to maximize strength and provide for ease of handling.

## RECPs are categorized as follows:

### a. Short-Term

(functional longevity 12 mo.)

#### i. Photodegradable

Straw blankets with a top and bottom side photo degradable net. The maximum size of the mesh shall be openings of 1/2" X 1/2". The blanket should be sewn together on 1.5" centers with degradable thread. Minimum thickness should be 0.35" and minimum density should be 0.5 lbs per square yard.

#### ii. Biodegradable

Straw blanket with a top and bottom side biodegradable jute net. The top side net shall consist of machine direction strands that are twisted

together and then interwoven with cross direction strands (leno weave). The bottom net may be leno weave or otherwise to meet requirements. The approximate size of the mesh shall be openings of 0.5" X 1.0". The blanket should be sewn together on 1.5" centers with degradable thread. Minimum thickness should be 0.25" and minimum density should be 0.5 lbs per square yard.

#### **b. Extended-Term**

(functional longevity 24 mo.)

##### **i. Photodegradable**

Blankets that consist of 70% straw and 30% coconut with a top and bottom side photodegradable net. The top net should have ultraviolet additives to delay breakdown. The maximum size of the mesh shall be openings of 0.65" X 0.65". The blanket should be sewn together on 1.5" centers with degradable thread. Minimum thickness should be 0.35" and minimum density should be 0.6 lbs per square yard.

##### **ii. Biodegradable**

Blankets that consist of 70% straw and 30% coconut with a top and bottom side biodegradable jute net. The top side net shall consist of machine direction strands that are twisted together and then interwoven with cross direction strands (leno weave). The bottom net may be leno weave or otherwise to meet requirements. The approximate size of the mesh shall be openings of 0.5" X 1.0". The blanket should be sewn together on 1.5" centers with degradable thread. Minimum thickness should be 0.25" and minimum density should be 0.65 lbs per square yard.

#### **c. Long-Term**

(functional longevity 36 mo.)

##### **i. Photodegradable**

Blankets that consist of 100% coconut with a top and bottom side photodegradable net. Each net should have ultraviolet additives to delay breakdown. The maximum size of the mesh shall be openings of 0.65" X 0.65". The blanket should be sewn together on 1.5" centers with degradable thread. Minimum thickness should be 0.3" and minimum density should be 0.5 lbs per square yard.

##### **iii. Biodegradable**

Blankets that consist of 100% coconut with a top and bottom side biodegradable jute net. The top side net shall consist of machine direction strands that are twisted together and then interwoven with cross direction strands (leno weave). The bottom net may be leno weave or otherwise to meet requirements. The approximate size of the mesh shall be openings of 0.5" X 1.0". The blanket should be sewn together on 1.5" centers with degradable thread. Minimum thickness should be 0.25" and minimum density should be 0.5 lbs per square yard.

#### **NOTES**

It is the intention of this section to allow interchangeable use of RECPs and HECs for erosion protection on slopes. The project engineer should select the type of erosion control product that best fits the need of the particular site.

#### **Site Preparation**

After the site has been shaped and graded to the approved design, prepare a friable seedbed relatively free from clods and rocks more than one inch in diameter, and any foreign material that will prevent contact of the soil stabilization mat with the soil surface. Surface must be smooth to ensure proper contact of blankets or matting to the soil surface. If necessary, redirect any runoff from the ditch or slope during installation.

#### **MAINTENANCE**

All erosion control blankets and matting should be inspected periodically following installation, particularly after rainstorms to check for erosion and undermining. Any dislocation or failure should be repaired immediately. If washouts or breakage occurs, reinstall the material after repairing damage to the slope or ditch. Continue to monitor these areas until they become permanently stabilized.



# TYPICAL INSTALLATION GUIDELINES FOR ROLLED EROSION CONTROL PRODUCTS (RECP)

## BLANKET AND MATTING CROSS-SECTIONS

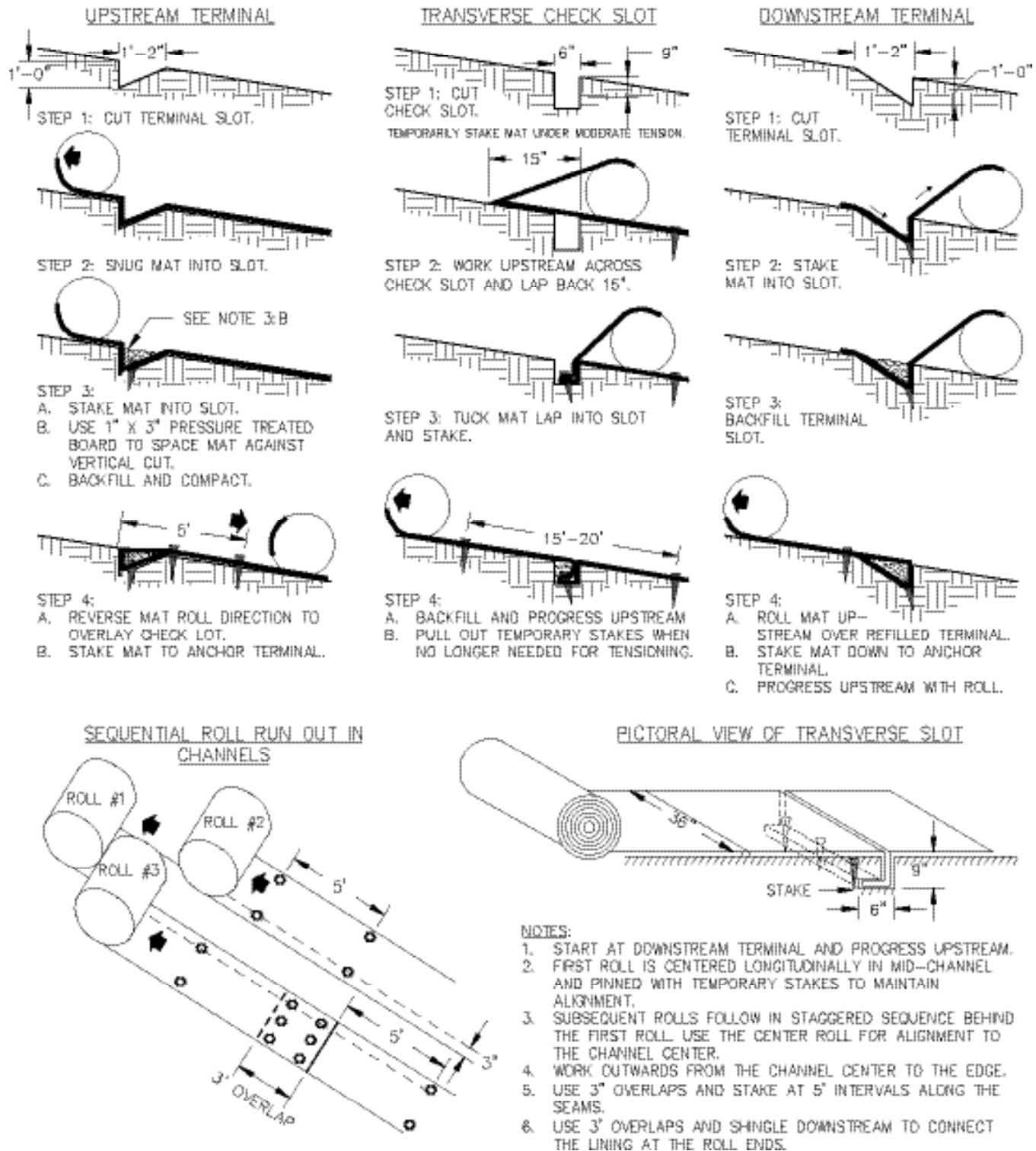

Figure 6-10.1 - Typical Installation Guidelines for Matting and Blankets



# TACKIFIERS

Tac



## DEFINITION

Tackifiers are used as a tie-down for soil, compost, seed, straw, hay or mulch. Tackifiers hydrate in water and readily blend with other slurry materials to form a homogenous slurry.

## PURPOSE

To reduce soil erosion from wind and water on construction sites. Other benefits include soil infiltration, soil fertility, enhanced seed germination, increased soil cohesion, enhanced soil stabilization, reduced stormwater runoff turbidity and reduction in loss of topsoil.

## CONDITIONS

This practice is intended for direct soil surface application to sites where the timely establishment of vegetation may not be feasible or where vegetation cover is absent or inadequate. Such areas include construction areas, where plant residues are inadequate to protect the soil surface and where land disturbing activities prevent the establishment or maintenance of a vegetative cover.

## CRITERIA

### Type I Tackifiers: Synthetic Polymers

Tac-1

- Application rates shall conform to manufacturer's guidelines for application.
- Only anionic forms of PAM shall be used. Anionic PAMs shall be no more than 0.05% acrylamide monomer by weight, as

established by the Food and Drug Administration and the Environmental Protection Agency.

- Not harmful to plants, animals and aquatic life.
- Contain no growth or germination inhibiting materials.
- Shall not reduce infiltration rates.

### Type II Tackifiers: Organic Polymers

Tac-2

Such as guar gum, polysaccharides, and starches

- Application rates shall conform to manufacturer's guidelines for application.
- Derived from natural plant sources.
- Not harmful to plants, animals and aquatic life.
- Contain no growth or germination inhibiting materials.
- Shall not reduce infiltration rates.

### Type III Tackifiers: Synthetic/Organic Blends

Tac-3

- Application rates shall conform to manufacturer's guidelines for application.
- Only anionic forms of PAM shall be used in the blend, and shall be no more than 0.05% acrylamide monomer by weight.
- Organic material must be derived from natural plant sources.
- Not harmful to plants, animals and aquatic life.
- Contain no growth or germination inhibiting materials.
- Shall not reduce infiltration rates.

**Type IV Tackifiers:  
Organic Tackifiers with  
Synthetic Fibers**

**Tac-4**

- Application rates shall conform to manufacturer's guidelines for application.
- Organic material must be derived from natural plant sources.
- Not harmful to plants, animals and aquatic life.
- Contain no growth or germination inhibiting materials.
- Shall not reduce infiltration rates.
- Synthetic fibers shall be of nylon or polyester blends.

**Type V Tackifiers:  
Synthetic/Organic Blends  
with Synthetic Fibers**

**Tac-5**

- Application rates shall conform to manufacturer's guidelines for application.
- Only anionic forms of PAM shall be used in the blend, and shall be no more than 0.05% acrylamide monomer by weight.
- Organic material must be derived from natural plant sources.
- Not harmful to plants, animals and aquatic life.
- Contain no growth or germination inhibiting materials.
- Shall not reduce infiltration rate.
- Synthetic fibers shall be of nylon or polyester blends.

**MAINTENANCE**

Tackified areas should be checked after every rain event. Periodic inspections and required maintenance must be provided per manufacturer's recommendations.

# **SECTION III: STRUCTURAL PRACTICES**



The E&S Act, O.C.G.A. § 12-7-6 (a)(4), and the state general permits (NPDES) Part IV., require an ES&PC Plan to be properly designed, installed and maintained using BMPs that are consistent with, and no less stringent than practices contained in this Manual.

The following structural BMPs in this Manual require worksheets or specifications to be shown on, and/or with the ES&PC Plan: Check Dam (Cd), Channel Stabilization (Ch), Diversion (Di), Temporary Downdrain Structure (Dn1), Rock Filter Dam (Rd), Retrofitting (Rt), Sediment Barrier (Sd1), Inlet Sediment Trap (Sd2) when excavated to provide sediment storage, Temporary Sediment Basin (Sd3), Temporary Sediment Trap (Sd4), Floating Surface Skimmer (Sk), Temporary Stream Crossing (Sr), Storm Drain Outlet Protection (St), and Vegetated Waterway or Stormwater Conveyance Channel (WT).

Most of the structural BMPs provide the maintenance requirements, and a figure showing proper installation procedures and specifications. When the design professional has chosen to use alternative BMPs that are not included in the Manual, a detail and maintenance requirements must be provided by the manufacturer or the design professional, and shown on the ES&PC Plan.

O.C.G.A. § 12-7-8 (a)(1) requires a local issuing authority (LIA) to enact an ordinance that meets or exceeds the standards, requirements, and provisions of the Act and the NPDES permits. However, the ordinance that the LIA enacts may not exceed the NPDES permit requirements for monitoring, reporting, inspections, design standards, turbidity standards, education and training, and project size thresholds with regard to education and training. Inspections are an important part of insuring that structural BMPs are properly maintained. For complete inspection and retention of records requirements please refer to the appropriate NPDES Permit.





# Check Dam

Cd



## DEFINITION

A temporary grade control structure, or dam constructed across a swale, drainage ditch, or area of concentrated flow.

## PURPOSE

To minimize the erosion rate by reducing the velocity of the storm water in areas of concentrated flow.

## CONDITIONS

This practice is applicable for use in small open channels and is not to be used in a live stream. Specific applications include:

1. Temporary or permanent swales or ditches in need of protection during establishment of grass linings.
2. Temporary or permanent swales or ditches that, due to their short length of service or other reasons, cannot receive a permanent non-erodible lining for an extended period of time.
3. Other locations where small localized erosion and resulting sedimentation problems exist.

## DESIGN CRITERIA

Check dams should be designed using 2.0 cfs. For any flows exceeding 2.0 cfs, check dams may be used in conjunction with other BMPs in the channel. Dam height should be 24 inches maximum measured to the center of the check dam.

## Drainage Area

For stone check dams, the drainage area shall not exceed two acres. For straw-bale check dams, the drainage area shall not exceed one acre.

## Side Slopes

Slide slopes shall be 2:1 or flatter.

## Spacing

Two or more check dams in a series shall be used for drainage areas greater than one (1) acre. Maximum spacing between dams should be such that the toe of the upstream dam is at the same elevation as the top of the downstream dam. (See Figure 6-12.1)

## Geotextiles

A geotextile should be used as a separator between the graded stone and the soil base and abutments. The geotextile will prevent the migration of soil particles from the subgrade into the graded stone. The geotextile shall be selected/specified in accordance with AASHTO M288-96 Section 7.3, *Separation Requirements*, Table 3. Geotextiles shall be “set” into the subgrade soils. The geotextile shall be placed immediately adjacent to the subgrade without any voids and extend five feet beyond the downstream toe of the dam to prevent scour.

## CONSTRUCTION SPECIFICATIONS

### Stone Check Dams

Cd-S

Stone check dams should be constructed of graded size 2-10 inch stone. Mechanical or hand placement shall be required to insure complete coverage of the entire width of the ditch or swale and that the center of the dam is lower than the edges. **The center of the check dam must be at least 9 inches lower than the outer edges.** (See Figure 6-12.2)

### Straw-bale Check Dams

Cd-Hb

Staked and embedded straw-bales may be used as temporary check dams in concentrated flow areas while vegetation is becoming established. They shall not be used where the drainage area exceeds one acre. Straw-bales should be installed per Figure 6-12.3.

## Installation

Bales should be bound with wire or nylon string. Twine bound bales are less durable. The bales should be placed in rows with bale ends tightly abutting the adjacent bales.

### Downstream Row (Refer to Figure 6-12.3)

Dig a trench across the small channel, wide enough and deep enough so that the top of the row of bales placed on their long, wide side is level with the ground. The tops of bales across the center of the channel should all be level and set at the same elevation. Place the bales in position and stake them according to the instructions below.

### Upstream Row

Dig another trench across the small channel, upstream and immediately adjacent to the first row of bales. The trench should be wide enough to accommodate a row of bales set vertically on their long edge. The trench should be deep enough so that at least 6 inches of each bale is below ground starting with the bale in the channel bottom. The trench should be as level as possible so that the tops of the bales across the center of the channel are level and water can flow evenly across them. Continue this trench up the side slopes of the small channel to a point where the unburied bottom line of the highest bale (Point "C", Figure 6-12.3) is higher than the top of the bales that are in the center of the channel (Point "D", Figure 6-12.3).

### Anchorage

Drive 2 x 2 stakes or #4 rebar through the bales and into the ground 1 1/2 to 2 feet for anchorage. The first stake in each bale should be driven toward a previously laid bale to force the bales together (See Figure 6-12.3).

Reference: Colorado NRCS Straw Bale Check Dam

### Compost Filter Sock

Cd-Fs

The filter sock should be staked in the center. If the compost filter sock is to be left as a permanent filter or part of the natural landscape, it may be seeded at time of installation for establishment of permanent vegetation.

Compost filter media used for compost filter sock filler material shall be weed free and derived from

a well-decomposed source of organic matter.

The compost shall be produced using an aerobic composting process meeting CFR 503 regulations including time and temperature data.

The compost shall be free of any refuse, contaminants or other materials toxic to plant growth. Non-composted products will not be accepted.

Test methods for the items below should follow US Composting Council Test Methods for the Examination of Composting and Compost guidelines for laboratory procedures:

- A. pH – 5.0-8.0 in accordance with TMECC 04.11-A, "Electrometric pH Determinations for Compost".
- B. Particle size – 99% passing a 2-inch (50 mm) sieve and a maximum of 40% passing a 3/8-inch (~ 9.5 mm) sieve, in accordance with TMECC 02.02-B, "Sample Sieving for Aggregate Size Classification". (Note - In the field, product commonly is between 1/2 and 2 inches (12.5 and 50 mm) particle size).
- C. Moisture content of less than 60% in accordance with standardized test methods for moisture determination.
- D. Material shall be relatively free (<1% by dry weight) of inert or foreign manmade materials.
- E. Sock containment system for compost filter media shall be a photodegradable or biodegradable knitted mesh material with 1/8 to 3/8 inch (3.2 to 9.5 mm) openings.

## MAINTENANCE

Periodic inspection and required maintenance must be provided. Sediment shall be removed when it reaches a depth of one-half the original dam height or before. If the area is to be mowed, check dams shall be removed once final stabilization has occurred. Otherwise check dams may remain in place permanently. After removal, the area beneath the dam shall be seeded and mulched immediately.

## TO BE SHOWN ON THE EROSION AND SEDIMENT CONTROL PLAN

1. cfs in the channel/ditch that the check dam is being used in: \_\_\_\_\_

2. Above 2.0 cfs: Yes \_\_\_\_\_ No \_\_\_\_\_

3. If Yes, list BMP being used in conjunction with check dams: \_\_\_\_\_

## STONE CHECK DAM SPACING BETWEEN CHECK DAMS

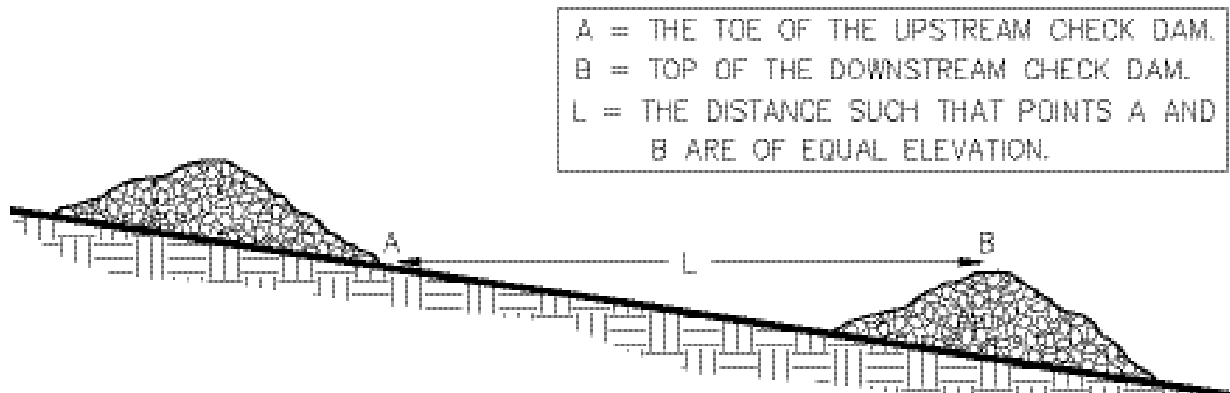
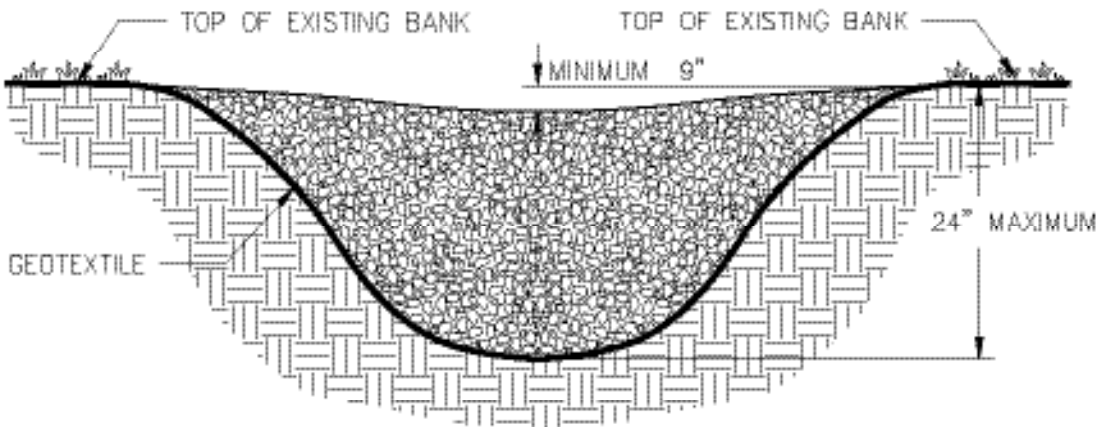

Figure 6-12.1

# STONE CHECK DAM

## CROSS SECTION



## PROFILE VIEW

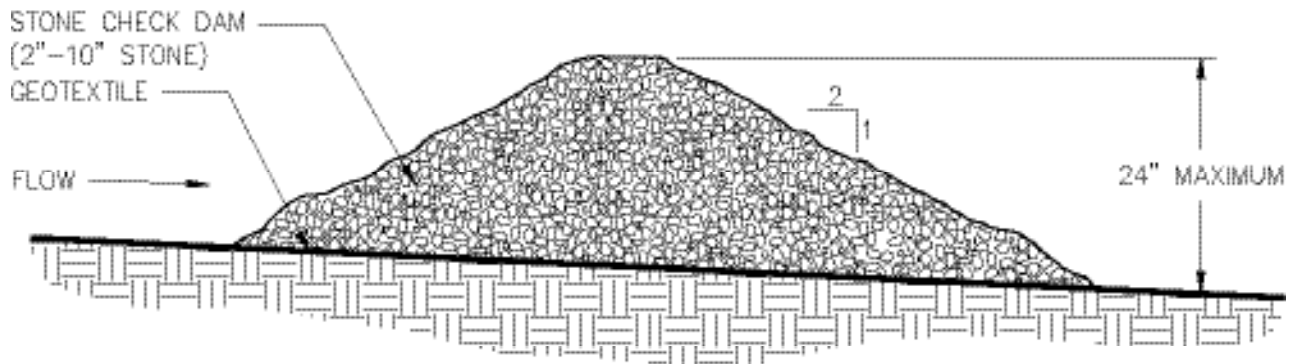

### NOTES:

1. CHECK DAMS ARE TO BE USED ONLY IN SMALL OPEN CHANNELS (THEY ARE NOT TO BE USED IN LIVE STREAMS).
2. THE DRAINAGE AREA FOR STONE CHECK DAMS SHALL NOT EXCEED TWO ACRES.
3. THE CENTER OF THE CHECK DAM MUST BE AT LEAST 9 INCHES LOWER THAN THE OUTER EDGES.
4. THE DAM HEIGHT SHOULD BE A MAXIMUM OF 2 FEET FROM CENTER TO RIM EDGE.
5. THE SIDE SLOPES OF THE CHECK DAM SHALL NOT EXCEED A 2:1 SLOPE.
6. GEOTEXTILE SHALL BE USED TO PREVENT THE MITIGATION OF SUBGRADE SOIL PARTICLES INTO THE STONES (REFER TO AASHTO M288-96, SECTION 7.3, TABLE 3).

Figure 6-12.2

# TYPICAL STRAW BALE CHECK DAM

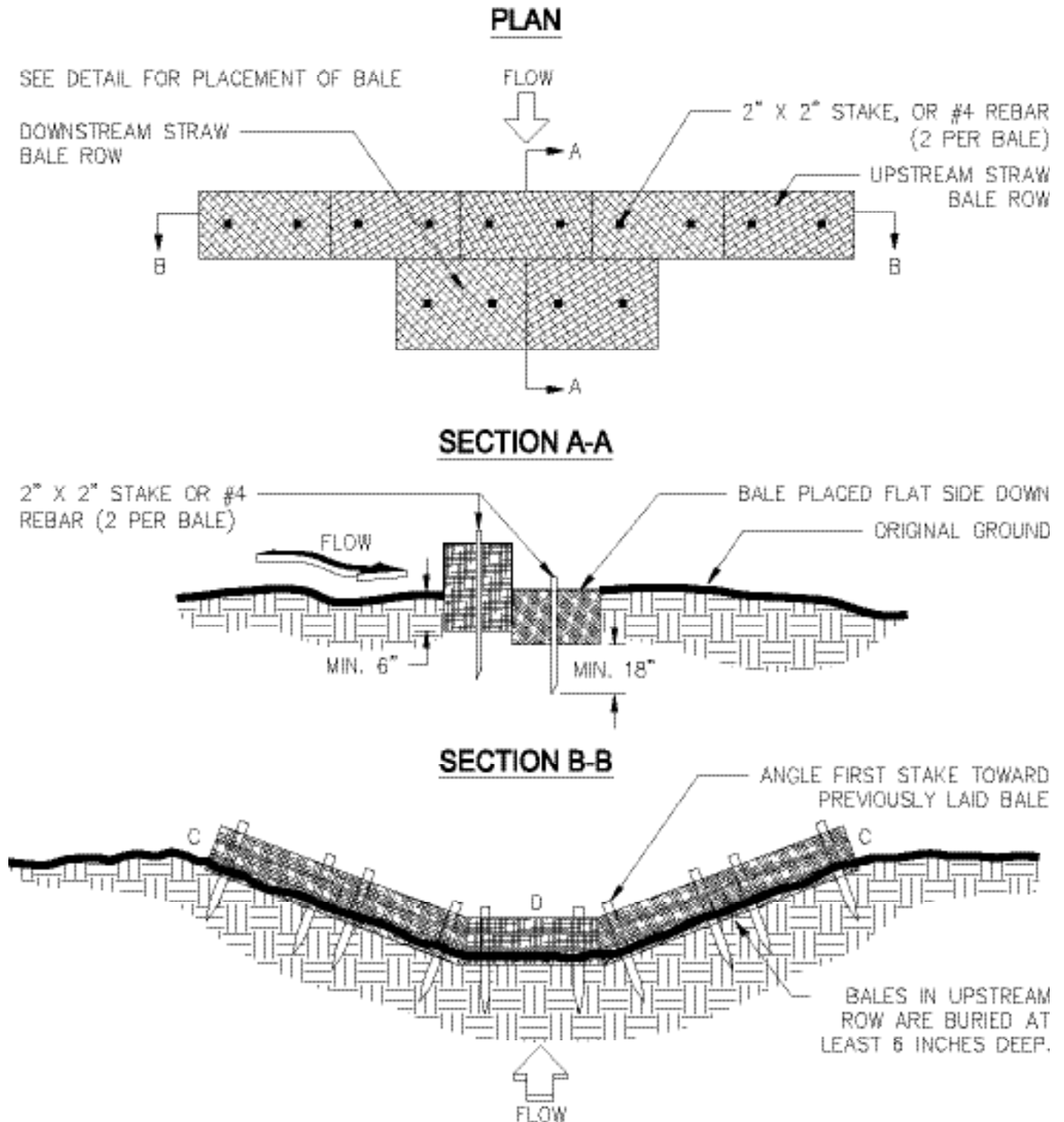

**NOTES:**

1. BALES SHOULD BE BOUND WITH WIRE OR NYLON STRING AND SHOULD BE PLACED IN ROWS WITH BALE ENDS TIGHTLY ABUTTING THE ADJACENT BALES.
2. REMOVE #4 REBAR AFTER STRAW BALES ARE NO LONGER IN PLACE.
3. POINT C OF SECTION B-B SHOULD ALWAYS BE HIGHER THAN POINT D.
4. STRAW-BALE CHECK DAMS SHALL NOT BE USED WHERE THE DRAINAGE AREA EXCEEDS ONE ACRE.

**Figure 6-12.3**

# Channel Stabilization

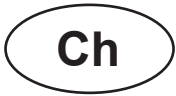

## DEFINITION

Improving, constructing or stabilizing an open channel for water conveyance.

## PURPOSE

Open channels are constructed or stabilized to be non-erosive, with no sediment deposition and to provide adequate capacity for flood water, drainage, other water management practices, or any combination thereof.

## CONDITIONS

This standard applies to the improvement, construction or stabilization of open channels and existing ditches with drainage areas less than one square mile. This standard applies only to channels conveying intermittent flow, not to channels conveying a continuous, live stream.

An adequate outlet for the modified channel length must be available for discharge by gravity flow. Construction or other improvements of the channel should not adversely affect the environmental integrity of the area and must not cause significant erosion upstream or flooding and/or sediment deposition downstream.

## DESIGN CRITERIA

### Planning

The alignment and design of channels shall give careful consideration to the preservation of valuable fish and wildlife habitat and trees of significant value for wildlife food or shelter or for aesthetic purposes.

Where channel construction will adversely af-

fect significant fish or wildlife habitat, mitigation measures should be included in the plan. Mitigation measures may include pools, riffles, flats, cascades or other similar provisions.

As many trees as possible are to be left inside channel rights-of-way considering the requirements of construction, operation, and maintenance.

Unusually large or attractive trees shall be preserved.

## Realignment

The realignment of channels shall be kept to an absolute minimum and should be permitted only to correct an adverse environmental condition.

## Channel Capacity

The capacity for open channels shall be determined by procedures applicable to the purposes to be served.

## Hydraulic Requirements

Manning's formula shall be used to determine velocities in channels. The "n" values for use in this formula shall be estimated using currently accepted guides along with knowledge and experience regarding the conditions. Acceptable guides can be found in hydrology textbooks.

## Channel Cross-Section

The required channel cross-section and grade are determined by the design capacity, the materials in which the channel is to be constructed, and the requirements for maintenance. A minimum depth may be required to provide adequate outlets for subsurface drains and tributary channels.

## Channel Stability

All channel construction, improvement and modification shall be in accordance with a design expected to result in a stable channel that can be maintained.

## Characteristics of a Stable Channel

1. Aggradation or degradation does not interfere with the function of the channel or affect adjacent areas.

2. The channel banks do not erode to the extent that the channel cross-section is changed appreciably.
3. Excessive sediment bars do not develop.
4. Excessive erosion does not occur around culverts, bridges or elsewhere.
5. Gullies do not form or enlarge due to the entry of uncontrolled surface flow to the channel.
6. The determination of channel stability considers "bankfull" flow. Bankfull flow is defined as flow in the channel that creates a water surface that is at or near normal ground elevation for a significant length of a channel reach. Excessive channel depth created by cutting through high ground should not be considered in determinations of bankfull flow.

## CHANNEL LININGS AND STRUCTURAL MEASURES

Where channel velocities exceed safe velocities for vegetated lining due to increased grade or a change in channel cross-section, or where durability of vegetative lining is adversely affected by seasonal changes, channel linings of rock, concrete or other durable material may be needed. Grade stabilization structures may also be needed.

The following categories for flow velocities shall apply when selecting the channel lining:

### Category 1 (less than 5 ft/sec\*) Ch-1

#### Vegetated Lining

A vegetated lining may be used to stabilize channels with a velocity of less than five ft/s temporary erosion control blankets or sod shall be used on all channels and concentrated flow areas to aid in the establishment of the vegetated lining. Refer to specifications **Ds3 - Disturbed Area Stabilization (With Permanent Vegetation)**, **Ds4 - Disturbed Area Stabilization (With Sodding)**, and **Ss - Slope Stabilization**, Hydraulic Erosion Control Products (HECPs) are not intended to be applied in channels, swales or other areas where concentrated flows are anticipated, unless installed in conjunction with Rolled Erosion Control Products (RECPs).

### Category 2 (greater than or equal to 5 ft/sec\* but less than 10 ft/sec\*)

Ch-2

#### Turf Reinforcement Matting

Turf Reinforcement Matting (TRM) shall be used, if a vegetated lining is used in channels with velocities greater than or equal to 5 feet/sec but less than 10 ft/sec. TRM is permanent geosynthetic erosion control matting that is used in channels to stabilize the soil while permanent vegetation is rooting, and to provide additional long-term protection.

Velocities in channels when flowing at the bankfull discharge or the 25-year frequency discharge, whichever is the greater, shall be used in determining the appropriate TRM for stabilization of the channels.

#### Rock Riprap Lining

Rock riprap shall be designed to resist displacement when the channel is flowing at the bankfull discharge or 25-year frequency discharge, whichever is the greater. Rock riprap lining should be used when channel velocities are greater than or equal to 5 ft/sec but less than 10 ft/sec.

Dumped and machine placed riprap should not be installed on slopes steeper than 1-1/2 horizontal to 1 vertical. Rock shall be dense, resistant to the action of air and water, and suitable in all other respects for the purpose intended. Rock shall be installed according to standards specified in Riprap, Appendix C.

A filter blanket layer consisting of an appropriately designed graded filter sand and/or gravel or geotextile material shall be placed between the riprap and base material. The gradation of the filter blanket material shall be designed to create a graded filter between the base material and the riprap. A geotextile can be used as a substitution for a layer of sand in a graded filter or as the filter blanket. Criteria for selecting an appropriate geotextile and guidance for recommended drop heights and stone weights are found in AASH-TO M288-96 Section 7.5, Permanent Erosion Control Specifications.

**Category 3 (greater than or equal to 10 ft/sec\*)**

Ch-3

**Concrete Lining**

If a channel has velocities high enough to require a concrete lining (when channel velocities exceed 10 ft/sec), methods should be utilized to reduce the velocity of the runoff and reduce erosion at the outlet - a common problem created by the smooth, concrete lining. Refer to specification **St - Storm Drain Outlet Protection** for information regarding energy dissipators.

If a concrete lining is chosen, it shall be designed according to currently accepted guides for structural and hydraulic adequacy. It must be designed to carry the required discharge and to withstand the loading imposed by site conditions.

A separation geotextile should be placed under concrete linings to prevent undermining in the event of stress cracks due to settlement of the base material. The separation geotextile will keep the base material soils in place and minimize the likelihood of a system failure.

**Grade Stabilization Structures**

Grade stabilization structures are used to reduce or prevent excessive erosion by reduction of velocities in the watercourse or by providing structures that can withstand and reduce the higher velocities. They may be constructed of concrete, rock, masonry, steel, aluminum, or treated wood.

These structures are constructed where the capability of earth and vegetative measures is exceeded in the safe handling of water at permissible velocities, where excessive grades or overall conditions are encountered or where water is to be lowered structurally from one elevation to another. These structures should generally be planned and installed along with or as a part of other erosion control practices.

The structures shall be designed hydraulically to adequately carry the channel discharge and structurally to withstand loadings imposed by the site conditions. The structure shall meet requirements of **Gr - Grade Stabilization Structure**.

\* The equivalent shear stress may also be used to determine the appropriate measure.

**TO BE SHOWN ON THE EROSION AND SEDIMENT CONTROL PLAN**

1. The velocity in the channel, in ft/sec, for when the channel is flowing at the bank-full discharge or 25-year frequency discharge, whichever is the greater.
2. The type of lining to be used to stabilize the channel, i.e. vegetation (Ch-1): indicate type of vegetation and matting or blanket to be used), riprap (Ch-2): indicate average stone size), or concrete (Ch-3).





# Construction Exit

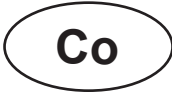

## DEFINITION

A stone stabilized pad located at any point where traffic will be leaving a construction site to a public right-of-way, street, alley, sidewalk or parking area or any other area where there is a transition from bare soil to a paved area.

## PURPOSE

To reduce or eliminate the transport of mud from the construction area onto public rights-of-way by motor vehicles or by runoff.

## CONDITIONS

This practice is applied at appropriate points of construction egress. Geotextile underliners are required to stabilize and support the pad aggregates.

## DESIGN CRITERIA

Formal design is not required. The following standards shall be used:

### Aggregate Size

Stone will be in accordance with National Stone Association R-2 (1.5 to 3.5 inch stone).

### Pad Thickness

The gravel pad shall have a minimum thickness of 6 inches.

### Pad Width

At a minimum, the width should equal full width of all points of vehicular egress, but not less than 20 feet wide.

### Pad Length

The gravel pad shall have a minimum length

of 50 feet. When the construction is less than 50' from the paved access, the length shall be from the edge of existing pavement to the permitted building being constructed.

## Washing

If the action of the vehicle traveling over the gravel pad does not sufficiently remove the mud, the tires should be washed prior to entrance onto public rights-of-way. When washing is required, it shall be done on an area stabilized with crushed stone and provisions that intercept the sediment-laden runoff and direct it into an approved sediment trap or sediment basin.

## Location

The exit shall be located or protected to prevent sediment from leaving the site.

## CONSTRUCTION SPECIFICATIONS

It is recommended that the egress area be excavated to a depth of 3 inches and be cleared of all vegetation and roots.

## Diversion Ridge

On sites where the grade toward the paved area is greater than 2%, a diversion ridge 6 to 8 inches high with 3:1 side slopes shall be constructed across the foundation approximately 15 feet above the road.

## Geotextile

The geotextile underliner must be placed the full length and width of the entrance. Geotextile selection shall be based on AASHTO M288-98 specification:

1. For subgrades with a CBR greater than or equal to 3 or shear strength greater than 90 kPa, geotextile must meet requirements of section AASHTO M288-96 Section 7.3, *Separation Requirements*.
2. For subgrades with a CBR between 1 and 3 or shear strength between 30 and 90 kPa, geotextile must meet requirements of section AASHTO M288-96 Section 7.4, *Stabilization Requirements*.

## MAINTENANCE

The exit shall be maintained in a condition that will prevent tracking or flow of mud onto public rights-of-way. This may require periodic top dressing with 1.5-3.5 inch stone, as conditions demand, and repair and/or cleanout of any structures to trap sediment. All materials spilled,

dropped, washed, or tracked from vehicles or site onto roadways or into storm drains must be removed immediately.

## CRUSHED STONE CONSTRUCTION EXIT

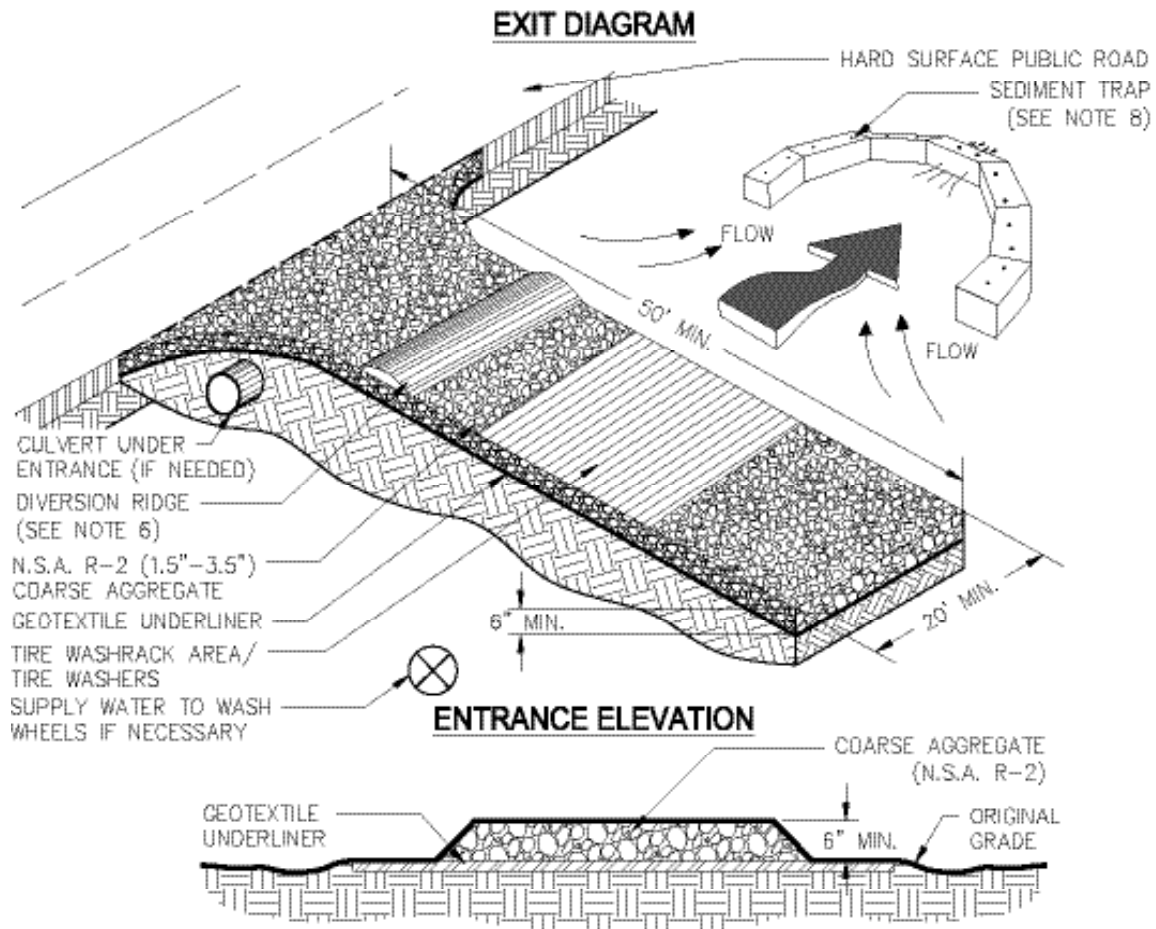

### NOTES:

1. AVOID LOCATING ON STEEP SLOPES OR AT CURVES ON PUBLIC ROADS.
2. REMOVE ALL VEGETATION AND OTHER UNSUITABLE MATERIAL FROM THE FOUNDATION AREA, GRADE, AND CROWN FOR POSITIVE DRAINAGE.
3. AGGREGATE SIZE SHALL BE IN ACCORDANCE WITH NATIONAL STONE ASSOCIATION R-2 (1.5"-3.5" STONE).
4. GRAVEL PAD SHALL HAVE A MINIMUM THICKNESS OF 6".
5. PAD WIDTH SHALL BE EQUAL FULL WIDTH AT ALL POINTS OF VEHICULAR EGRESS, BUT NO LESS THAN 20'.
6. A DIVERSION RIDGE SHOULD BE CONSTRUCTED WHEN GRADE TOWARD PAVED AREA IS GREATER THAN 2%.
7. INSTALL PIPE UNDER THE ENTRANCE IF NEEDED TO MAINTAIN DRAINAGE DITCHES.
8. WHEN WASHING IS REQUIRED, IT SHOULD BE DONE ON AN AREA STABILIZED WITH CRUSHED STONE THAT DRAINS INTO AN APPROVED SEDIMENT TRAP OR SEDIMENT BASIN (DIVERT ALL SURFACE RUNOFF AND DRAINAGE FROM THE ENTRANCE TO A SEDIMENT CONTROL DEVICE).
9. WASH RACKS AND/OR TIRE WASHERS MAY BE REQUIRED DEPENDING ON SCALE AND CIRCUMSTANCE. IF NECESSARY, WASH RACK DESIGN MAY CONSIST OF ANY MATERIAL SUITABLE FOR TRUCK TRAFFIC THAT REMOVE MUD AND DIRT.
10. MAINTAIN AREA IN A WAY THAT PREVENTS TRACKING AND/OR FLOW OF MUD ONTO PUBLIC RIGHTS-OF-WAYS. THIS MAY REQUIRE TOP DRESSING, REPAIR AND/OR CLEANOUT OF ANY MEASURES USED TO TRAP SEDIMENT.

Figure 6-14.1

# Construction Road Stabilization

Cr



## DEFINITION

A travelway constructed as part of a construction plan including access roads, subdivision roads, parking areas, and other on-site vehicle transportation routes.

## PURPOSE

To provide a fixed travel route for construction traffic and reduce erosion and subsequent regrading of permanent roadbeds between time of initial grading and final stabilization.

## CONDITIONS

This practice is applicable where travelways are needed in a planned land use area or wherever stone-base roads or parking areas are constructed, whether permanent or temporary, for use by construction traffic.

## PLANNING CONSIDERATIONS

Areas graded for construction vehicle transport and parking purposes are especially susceptible to erosion. The exposed soil is continuously disturbed, eliminating the possibility of stabilization with vegetation. The prolonged exposure of the roads and parking areas to surface runoff can create severe rilling and muddying of the areas, requiring regrading before paving. The soil removed during this process may enter streams and other waters of the state via storm-water management systems, compromising the water quality. Also, because the roads become so unstable during wet weather, they are virtually unusable, limiting access, and causing delays in construction.

## DESIGN CRITERIA

### Temporary Roads and Parking Areas

The type of vehicle or equipment, speed, loads, climatic, and other conditions under which vehicles and equipment are expected to operate shall be considered.

### Location

Temporary roads shall be located to serve the purpose intended, facilitate the control and disposal of water, control or reduce erosion, and make the best use of topographic features.

Temporary roads shall follow the contour of the natural terrain to minimize disturbance of drainage patterns. If a temporary road must cross a stream, the crossing must be designed, installed and maintained according to specification **Sr - Temporary Stream Crossing**.

Temporary parking areas should be located on naturally flat areas to minimize grading.

### Grade and Alignment

The gradient and vertical and horizontal alignment shall be adapted to the intensity of use, mode of travel, and level of development.

Grades for temporary roads should not exceed 10 percent except for very short lengths (200 feet or less), but maximum grades of 20 percent or more may be used if necessary for special uses. Frequent grade changes generally cause fewer erosion problems than long continuous gradients.

Curves and switchbacks must be of sufficient radius for trucks and other large vehicles to negotiate easily. On temporary roads, the radius should be no less than 35 feet for standard vehicles and 50 feet for tractor-trailers.

Grades for temporary parking areas should be sufficient to provide drainage but should not exceed 4 percent.

### Width

Temporary roadbeds shall be at least 14 feet wide for one-way traffic and 20 feet wide for two-way traffic. The width for two-way traffic shall be increased approximately 4 feet for trailer traffic. A minimum shoulder width shall be 2 feet on each side. Where turnouts are used, road width shall be increased to a minimum of 20 feet for a

distance of 30 feet.

### Side Slopes

All cuts and fills shall have side slopes designed to be stable for the particular site conditions and soil materials involved. All cut and fills shall be 2:1 or flatter to the extent possible. When maintenance by machine mowing is planned, side slopes shall be no steeper than 3:1.

### Drainage

The type of drainage structure used will depend on the type of enterprise and runoff conditions. The capacity and design shall be consistent with sound engineering principles and shall be adequate for the class of vehicle, type of road, development, or use. Structures should be designed to withstand flows from a 25-year, 24-hour frequency storm or the storm specified in Title 12-7-1 of the Official Code of Georgia Annotated. Channels shall be designed to be on stable grades or protected with structures or linings for stability.

Water breaks or bars may be used to control surface runoff on low-intensity use roads.

### Stabilization

Geotextile should be applied to the roadbed for additional stability. Geotextile selection shall be based on AASHTO M288-98 specification:

1. For subgrades with a CBR greater than or equal to 3 or shear strength greater than 90 kPa, geotextile must meet requirements of section AASHTO M288-96 Section 7.3, *Separation Requirements*.
2. For subgrades with a CBR between 1 and 3 or shear strength between 30 and 90 kPa, geotextile must meet requirements of section AASHTO M288-96 Section 7.4, *Stabilization Requirements*.

A 6-inch course of coarse aggregate shall be applied immediately after grading or the completion of utility installation within the right-of-way. In areas experiencing "heavy duty" traffic situations, stone should be placed at an 8 to 10 inch depth to avoid excessive dissipation or maintenance needs.

All roadside ditches, cuts, fills, and disturbed

areas adjacent to parking areas and roads shall be stabilized with appropriate temporary or permanent vegetation according to specification in **Ds2 - Disturbed Area Stabilization (With Temporary Seeding)** and **Ds3 -Disturbed Area Stabilization (With Permanent Vegetation)**.

### PERMANENT ROADS AND PARKING AREAS

Permanent roads and parking areas shall be designed and constructed according to criteria established by the Georgia Department of Transportation or local authority. Permanent roads and parking areas shall be stabilized in accordance with this specification, applying an initial base course of gravel immediately following grading.

### CONSTRUCTION SPECIFICATIONS

1. Trees, stumps, roots, brush, weeds, and other objectionable materials shall be removed from the work area.
2. Unsuitable material shall be removed from the roadbed and parking areas.
3. Grading, subgrade preparation, and compaction shall be done as needed. Fill material shall be deposited in layers not to exceed 9 inches and compacted with the controlled movement of compacting and earth moving equipment.
4. The roadbed and parking area shall be graded to the required elevation. Subgrade preparation and placement of the surface course shall be in accordance with sound highway construction practice.
5. Structures such as culverts, pipe drops, or bridges shall be installed to the lines and grades shown on the plans or as staked in the field. Pipe conduits shall be placed on a firm foundation. Selected backfill material shall be placed around the conduit in layers not to exceed 6 inches. Each layer shall be properly compacted.
6. Roads shall be planned and laid out according to good landscape management principles.

## **MAINTENANCE**

Roads and parking areas may require a periodic top dressing of gravel to maintain the gravel depth at 6 inches. Vegetated areas should be checked periodically to ensure a good stand of vegetation is maintained. Remove any silt or other debris causing clogging of roadside ditches or other drainage structure.



# Stream Diversion Channel

Dc



## DEFINITION

A temporary channel constructed to convey flow around a construction site while a permanent structure is being constructed in the stream channel.

## PURPOSE

To protect the streambed from erosion and allow work “in the dry”.

## CONDITIONS

Temporary stream diversion channels shall be used only on flowing streams with a drainage area less than one square mile. Structures or methodology for crossing streams with larger drainage areas should be designed by methods that more accurately define the actual hydrologic and hydraulic parameters that will affect the functioning of the structure. A Stream Buffer Variance from the GA EPD may be required, unless

specifically exempt from the Act and all other appropriate agencies, including the U.S. Army Corps of Engineers, must be contacted to ensure compliance with other laws.

## PLANNING CONSIDERATIONS

Linear projects, such as utilities or roads, frequently cross and impact live streams creating a potential for excessive sediment loss into a stream by both the disturbance of the approach areas and by the work within the streambed and banks.

In cases where in-stream work is unavoidable, the amount of encroachment and time spent working in the channel shall be minimized. If construction in the streambed will take an extended period of time, substantial in-stream controls or stream diversion channel should be considered to prevent excessive sedimentation damage. To limit land-disturbance, overland pumping of the stream should be considered in low-flow conditions. Clearing of the streambed and banks shall be kept to a minimum.

## DESIGN CRITERIA

### Drainage Area

Temporary stream diversion channels shall not be used on streams with drainage areas greater than one square mile.

### Size

The bottom width of the stream diversion shall be a minimum of six feet or equal to the bottom width of the existing streambed, whichever is greater.

<b>Lining Materials</b>	<b>Symbol</b>	<b>Acceptable Velocity Range</b>
Geotextile, polyethylene film, or sod	Dc-A	0 -2.5 fps
Geotextile alone	Dc-B	2.5 -9.0 fps
Class I riprap and geotextile	Dc-C	9.0 -13.0 fps



### Side Slopes

Side slopes of the stream diversion channel shall be no steeper than 2:1.

### Depth and Grade

Depth and grade may be variable, dependent on site conditions, but shall be sufficient to ensure continuous flow of water in the diversion.

### Channel Lining

A stream diversion channel shall be lined to prevent erosion of the channel and sedimentation in the stream. The lining is selected based upon the expected velocity of bankfull flow. Table 6-16.1 shows the selection of channel linings that may be used. Refer to specification **Ss- Slope Stabilization**.

### Geotextile

Geotextiles should be used as a protective cover for soil or, if the channel is to be lined with rip-rap, as a separator between graded stone and the soil base. The geotextile will prevent erosion of the channel and the migration of soil particles from the subgrade into the graded stone. The geotextile shall be specified in accordance with AASHTO M288-96 Section 7.5, *Permanent Erosion Control Recommendations*. The geotextile should be placed immediately adjacent to the subgrade without any voids.

## CONSTRUCTION SPECIFICATIONS

1. The channel shall be excavated, constructing plugs at both ends. Plugs can be constructed of compacted soil, riprap, sandbags or sheet piling.
2. Sediment barrier or a berm shall be placed along the sides of the channel to prevent unfiltered runoff from entering the stream. The berm can be constructed using the material excavated for the stream diversion.
3. The channel surface shall be smooth (to prevent tearing of the liner) and lined with the material specified in the plans. The outer edges of the geotextile shall be secured at the top of the channel with compacted soil.
4. The plugs are removed when the liner installation is complete, removing the downstream

plug first.

5. As soon as construction in the streambed is complete, the diversion shall be replugged and backfilled. The liner should be inspected for damage and salvaged if possible.
6. Upon removal of the lining, the stream shall immediately be restored and properly stabilized.

## MAINTENANCE

The stream diversion channel shall be inspected at the end of each day to make sure that the construction materials are positioned securely. This will ensure that the work area stays dry and that no construction materials float downstream. All repairs shall be made immediately.

# STREAM DIVERSION CHANNEL

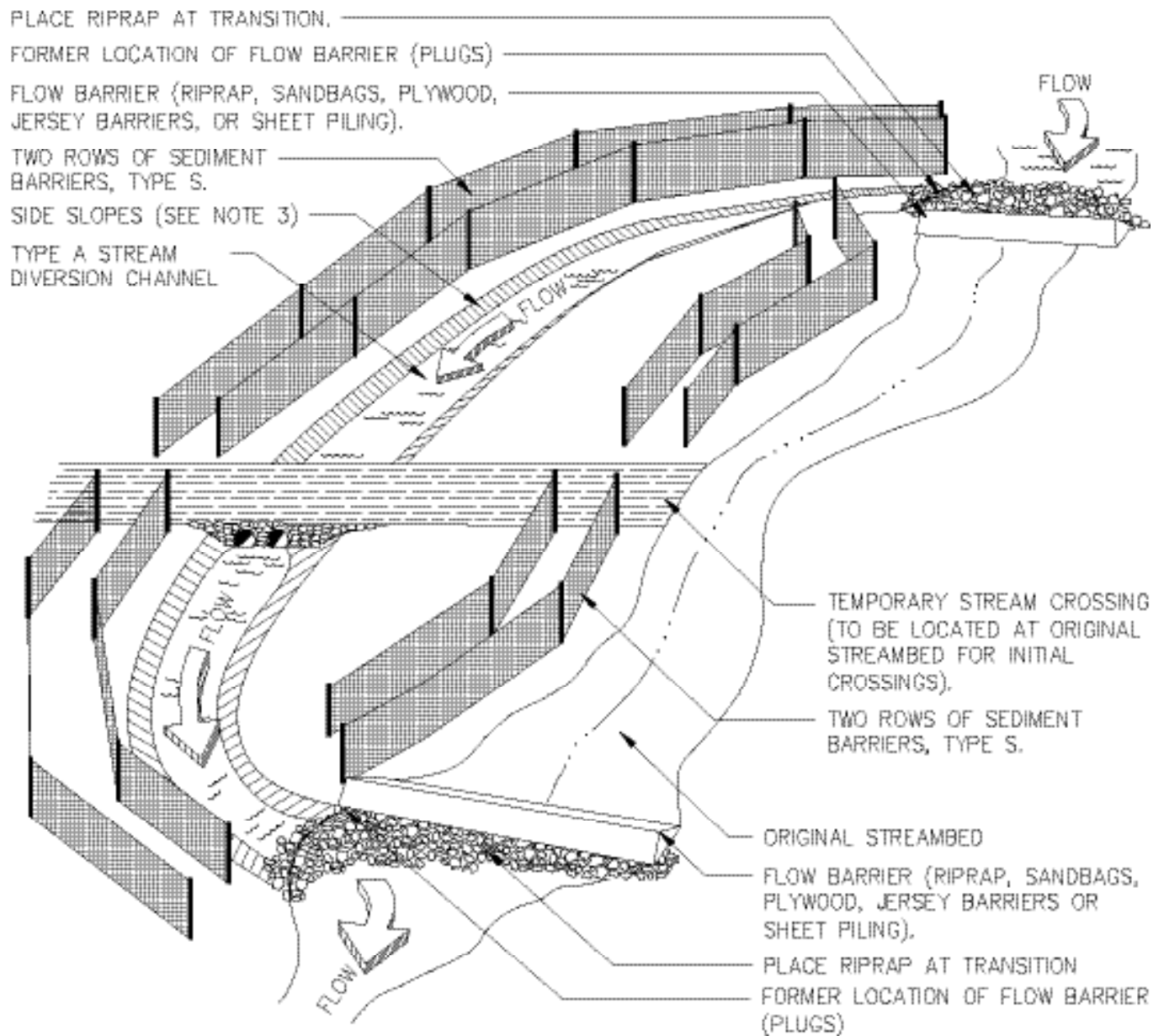

**NOTES:**

1. THE BOTTOM WIDTH OF THE STREAM DIVERSION SHALL BE A MINIMUM OF SIX FEET OR EQUAL TO THE BOTTOM WIDTH OF THE EXISTING STREAMBED (WHICHEVER IS GREATER).
2. SIDE SLOPES OF THE STREAM DIVERSION CHANNEL SHALL BE NO STEEPER THAN 2:1.
3. THE CHANNEL SHALL BE EXCAVATED, CONSTRUCTING PLUGS AT BOTH ENDS.
4. TWO ROWS OF TYPE S SEDIMENT BARRIERS SHALL BE PLACED ALONG THE SIDES OF THE CHANNEL TO PREVENT UNFILTERED RUNOFF FROM ENTERING THE STREAM.
5. THE CHANNEL SURFACE SHALL BE SMOOTH (TO PREVENT TEARING OF THE LINER) AND LINED WITH THE MATERIAL SPECIFIED IN THE PLANS.
6. THE PLUGS ARE REMOVED WHEN THE LINER INSTALLATION IS COMPLETE (REMOVING THE DOWNSTREAM PLUG FIRST).

**Figure 6-16.1. Stream Diversion Channel (perspective view)**

# TO BE SHOWN ON EROSION, SEDIMENTATION AND POLLUTION CONTROL PLAN

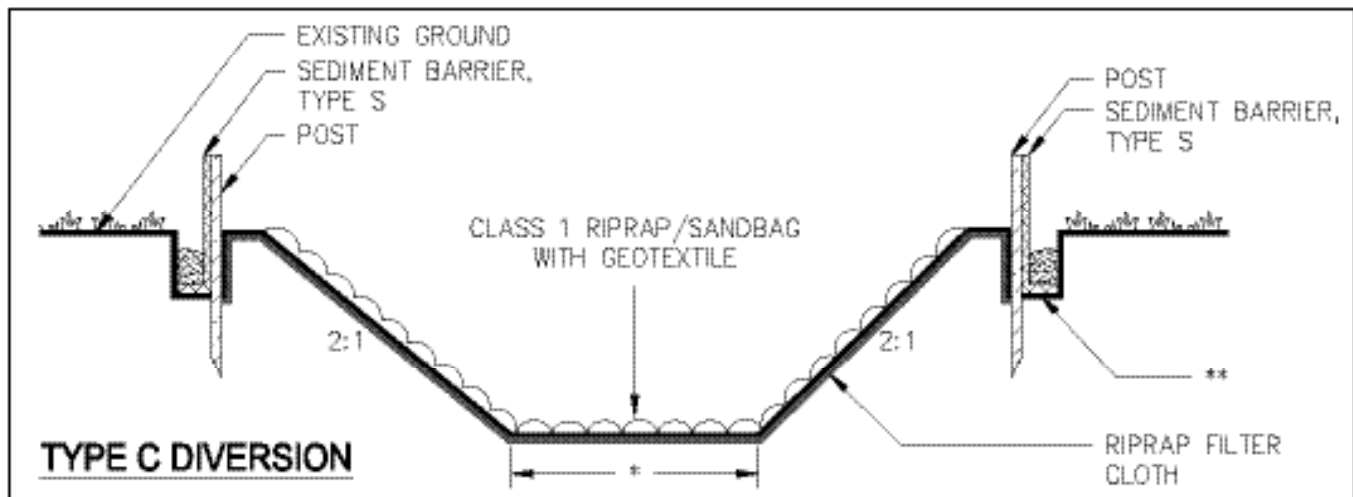
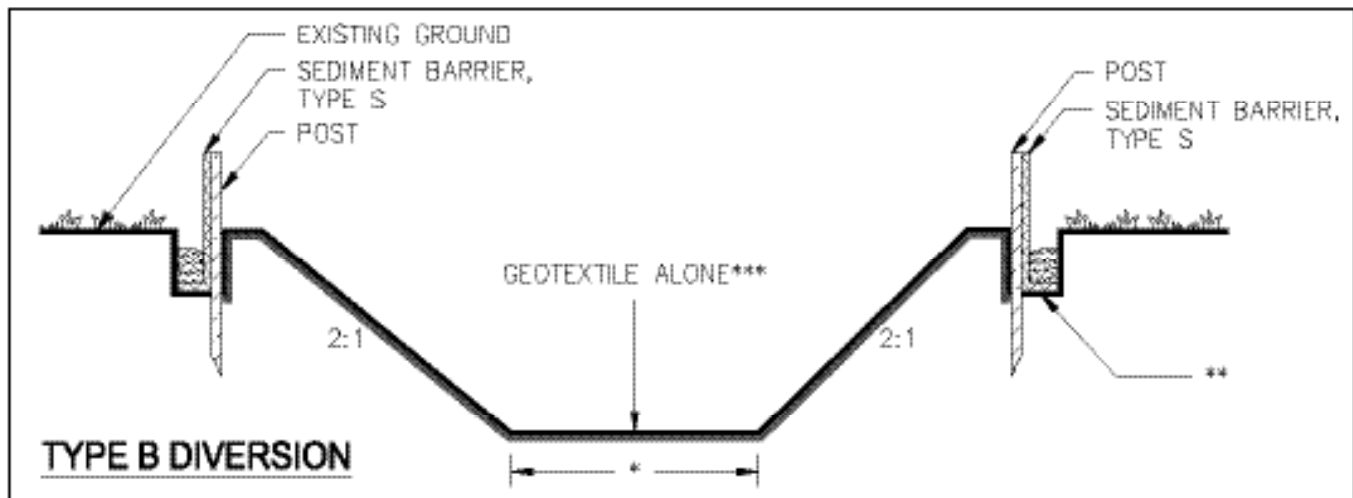
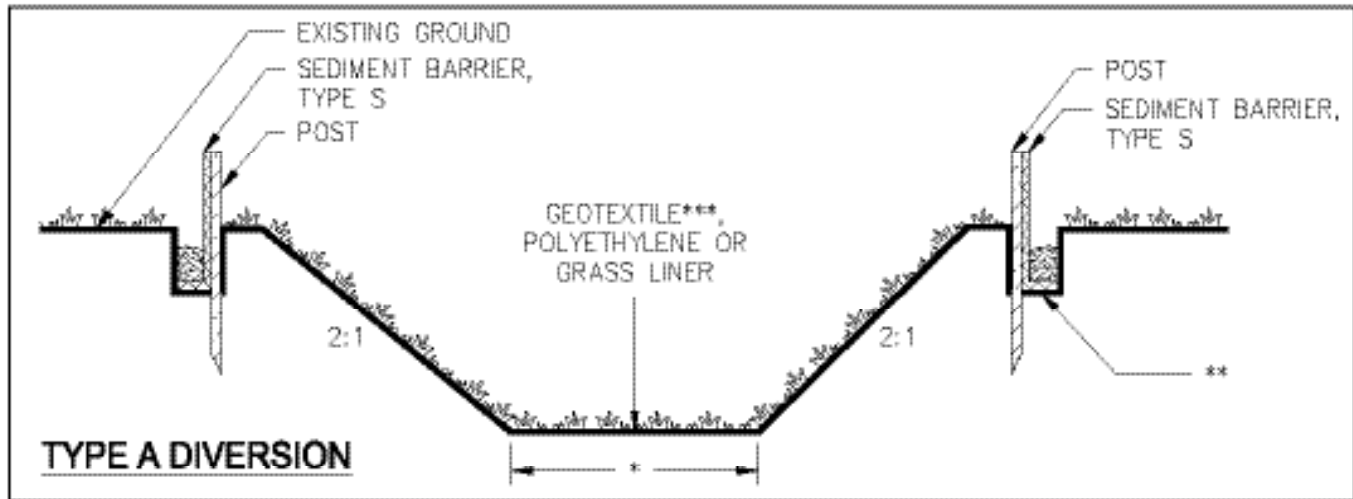

- \* 6' MINIMUM OR WIDTH OF EXISTING STREAM (WHICHEVER IS GREATER)
- \*\* SEDIMENT BARRIER AND FILTER CLOTH SHOULD BE ENTRENCHED IN THE SAME TRENCH.
- \*\*\*GEOTEXTILE SHALL BE SPECIFIED IN ACCORDANCE WITH AASHTO M288-96 SECTION 7.5

Figure 6-16.2. Stream Diversion Channel Linings

# Diversion



## DEFINITION

A ridge of compacted soil, constructed above, across or below a slope.

## PURPOSE

To reduce the erosion of steep, or otherwise highly erodible areas by reducing slope lengths, intercepting storm runoff and diverting it to a stable outlet at a non-erosive velocity.

## CONDITIONS

Diversions are applicable when:

1. Runoff from higher areas is or has potential for damaging property, causing erosion, contributing to pollution, flooding, interfering with or preventing the establishment of vegetation on lower areas.
2. Surface and/or shallow subsurface flow is damaging sloping upland.
3. The length of slope needs to be reduced so that soil loss will be reduced to a minimum.

This standard applies to temporary and permanent diversions in developments involving land-disturbing activities.

## DESIGN CRITERIA

### Location

Diversion location shall be determined by considering outlet conditions, topography, land use, soil type, length of slope, seep planes (when seepage is a problem), and the development layout. Diversions should be tailored to fit the conditions for a particular field and local soil type(s).

A diversion consists of two components that must be designed - the ridge and the channel.

### Ridge Design

The ridge shall be compacted and designed to have stable side slopes, which shall not be steeper than 2:1. The ridge shall be a minimum width of four feet at the design water elevation after settlement. Its design shall allow ten percent for settlement.

### Channel Design

Land slope must be taken into consideration when choosing channel dimensions. On the steeper slopes, narrow and deep channels may be required. On the more gentle slopes, broad, shallow channels usually are applicable. The wide, shallow section will be easier to maintain. Since sediment deposition is often a problem in diversions, the designed flow velocity should be kept as high as the channel lining will permit.

Table 6-17.1 indicates the storm frequency required for the design of the diversion. The required storm frequency is based on the purpose of the diversion. The storm frequency is used to determine the required channel capacity, Q (peak rate of runoff).

The channel portion of the diversion may have a parabolic or trapezoidal cross-section. Detailed information for the design of these channels is provided in the specification **Wt - Stormwater Conveyance Channel**.

### Outlets

Each diversion must have an adequate outlet. The outlet may be a constructed or natural waterway, a stabilized vegetated area or a stabilized open channel. In all cases, the outlet must discharge in such a manner as to not cause an erosion problem. Protected outlets shall be constructed and stabilized prior to construction of the diversion.

### Stabilization

Channels shall be stabilized in accordance with item 5 of the construction specifications.

### Diversions For Roads and Utility Rights - of Way

A detailed design is not required for this type of diversion. Diversions installed to divert water

off a road or right-of-way shall consist of a series of compacted ridges of soil running diagonally across the road at a 30° angle. Ridges are constructed by excavating a channel up-stream for this type of diversion.

The compacted ridge height shall be 8-12" above the original road surface; the channel depth shall be 8-12" below the original road surface. Channel bottoms and ridge tops shall be smooth enough to be crossed by vehicular traffic. The maximum spacing between diversions shall be as follows:

Road Grade (Percent)	Distance Between Diversions (Feet)
1	400
2	250
5	125
10	80
15	60
20	50

## TYPICAL DIVERSION ACROSS ROAD CROSS SECTION

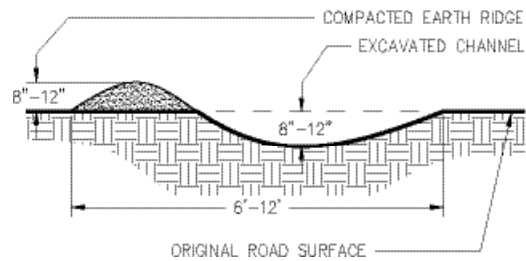

Figure 6-17.1

Stable outlets shall be provided for each diversion.

### CONSTRUCTION SPECIFICATIONS

1. All trees, brush, stumps, obstructions, and other objectionable material shall be removed and disposed of so as not to interfere with the proper functioning of the diversion.
2. The diversion shall be excavated or shaped to line, grade, and cross section as required to meet the criteria specified herein and free of irregularities that will impede normal flow.
3. All fills shall be machine compacted as needed to prevent unequal settlement that would cause damage in the completed diversion.
4. All earth removed and not needed in construction shall be spread or disposed of so that it will not interfere with the functioning of the diversion.
5. Diversion channel shall be stabilized in accordance with specification **Ch - Channel Stabilization**.

**Table 6-17.1. Diversion Design Criteria**

<b>Diversion Type</b>	<b>Land or Improvement Protected</b>	<b>Storm Frequency<sup>1</sup></b>	<b>Freeboard</b>	<b>Minimum Top Width</b>
Temporary	Construction areas Building sites	10 yrs <sup>2</sup>	0.3'	4'
Permanent	Landscaped, recreation and similar areas.	25 yrs	0.3'	4'
	Dwellings, schools, commercial bldgs., and similar installations	50 yrs	0.5'	4'

<sup>1</sup> Use 24-hr storm duration

<sup>2</sup> Use 10 yrs or the storm for the storm frequency specified in Title 12 of the Official Code of Georgia Annotated

## SHOWN ON THE EROSION AND SEDIMENT CONTROL PLAN

COMPLETE THE APPROPRIATE DETAIL DRAWING FOR THE CHANNEL CROSS-SECTION OF CHOICE:

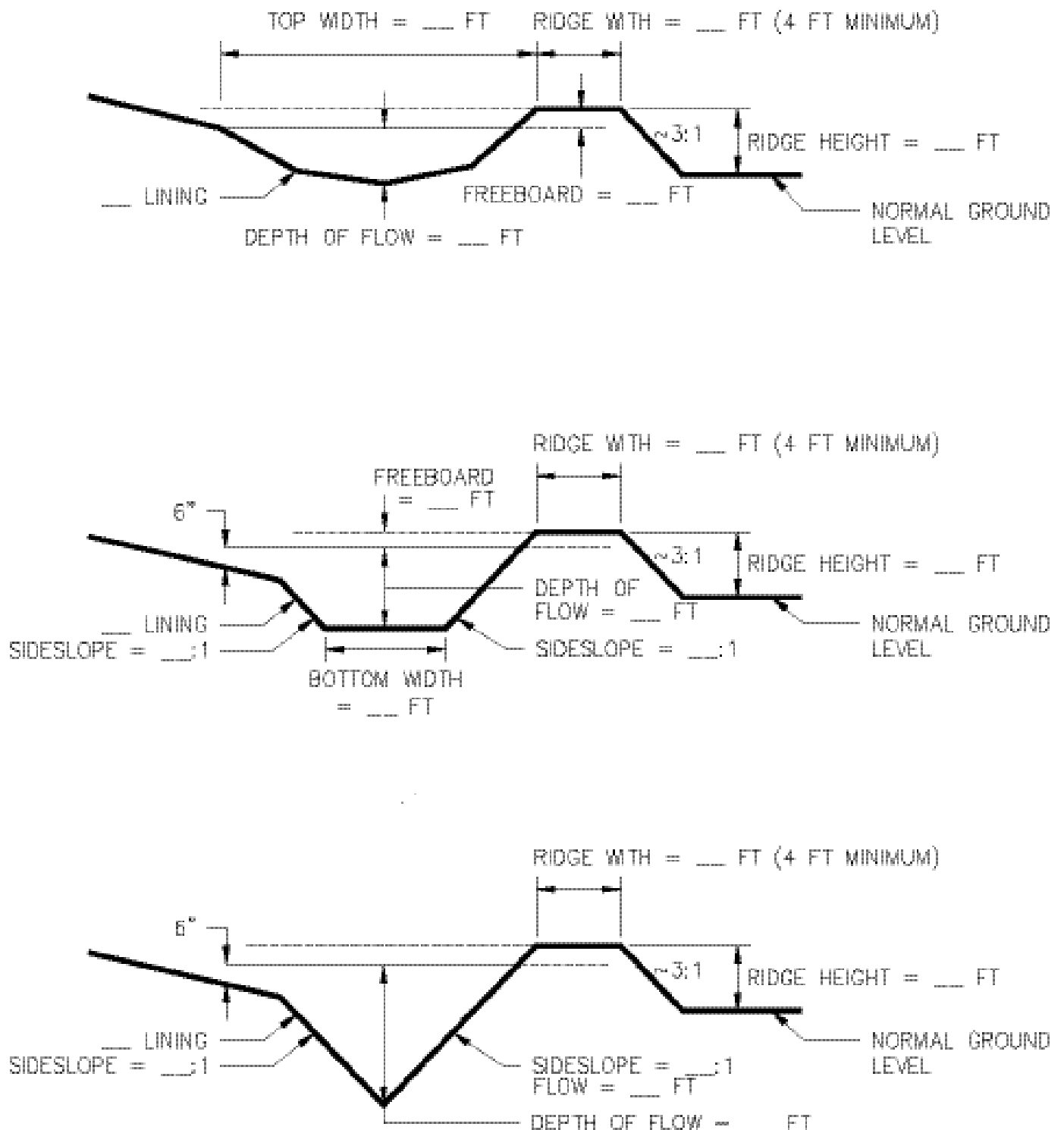

Figure 6-17.2

# Temporary Downdrain Structure

Dn1



## DEFINITION

A temporary structure used to convey concentrated storm water down the face of cut or fill slopes.

## PURPOSE

To safely conduct storm runoff from one elevation to another without causing slope erosion and allowing the establishment of vegetation on the slope.

## CONDITIONS

Temporary downdrains are used on slopes where a concentration of storm water could cause erosion damage. **These structures are removed once the permanent stormwater disposal system is installed.**

## DESIGN CRITERIA

Formal design is not required. The following standards shall be used:

### Placement

The temporary downdrain shall be located on undisturbed soil or well-compacted fill.

### Diameter

The diameter of the temporary downdrain shall provide sufficient capacity required to convey the maximum runoff expected during the life of the drain. Refer to Table 6-18.1 for selecting pipe sizes.

### Downdrain Inlet and Outlet

Diversions are used to route runoff to the downdrain's Tee or "L" inlet at the top of the

Table 6-18.1. Pipe Diameter for Temporary Downdrain Structure

Maximum Drainage Area Per Pipe (acre)	Pipe Diameter (inches)
0.3	10
0.5	12
1.0	18

slope. Slope the entrance 1/2" per foot toward the outlet. Thoroughly compact selected soil around the inlet section to prevent the pipe from being washed out by seepage or piping. A stone filter ring or check dam may be placed at the inlet for added sediment filtering capacity. Refer to **Cd - Check Dam** and **Fr - Stone Filter Ring**. These sediment filtering devices should be removed if flooding or bank overwash occurs.

Rock riprap shall be placed at the outlet for energy dissipation. A Tee outlet, flared end section, or other suitable device may be used in conjunction with the riprap for additional protection. See Figure 6-18.1. Refer to specification **St - Storm Drain Outlet Protection**.

## Pipe Material

Design the slope drain using heavy-duty, flexible materials such as non-perforated, corrugated plastic pipe or specially designed flexible tubing. Use reinforced, hold-down grommets or stakes to anchor the pipe at intervals not to exceed 10 feet with the outlet end securely fastened in place. The pipe must extend beyond the toe of the slope.

## CONSTRUCTION SPECIFICATIONS

A common failure of slope drains is caused by water saturating the soil and seeping along the pipe. This creates voids from consolidation and causes washouts. Proper back-filling around and under the pipe "haunches" with stable soil material and hand compacting in 6-inch lifts to achieve firm contact between the pipe and the soil at all points will eliminate this type of failure.

1. Place slope drains on undisturbed soil or well-compacted fill at locations and elevations shown on the plan.
2. Slightly slope the section of pipe under the dike toward its outlet.



3. Hand tamp the soil under and around the entrance section in lifts not to exceed 6 inches.
4. Ensure that fill over the drain at the top of the slope has minimum dimensions of 1.5 ft. depth, 4 ft. top width, and 3:1 side slopes.
5. Ensure that all slope drain connections are watertight.
6. Ensure that all fill material is well-compacted. Securely fasten the exposed section of the drain with grommets or stakes spaced no more than 10 feet apart.
7. For slopes steeper than 2:1, slope drains should be placed diagonally across the slope, extending the drain beyond the toe of the slope. Curve the outlet uphill and adequately protect the outlet from erosion.
8. If the drain is conveying sediment-laden runoff, direct all flows into a sediment trap

or sediment basin.

9. Make the settled, compacted dike ridge no less than one foot above the top of the pipe at every point.
10. Immediately stabilize all disturbed areas following construction.

#### **MAINTENANCE**

Inspect the slope drain and supporting diversion after every rainfall and promptly make necessary repairs. When the protected area has been permanently stabilized and the permanent stormwater disposal system is fully functional, temporary measures may be removed, materials disposed of properly, and all disturbed areas stabilized appropriately. Refer to specifications **Ds3** and **Ds4 - Disturbed Area Stabilization (With Permanent Vegetation and Sodding)**, respectively, and **Ss - Slope Stabilization**.

#### **TO BE SHOWN ON THE EROSION AND SEDIMENT CONTROL PLAN**

1. **The drainage area for each down drain**, in acres.
2. **The diameter of each down drain**, in inches, based on Table 6-18.1.
3. **The dimensions of the outlet protection**, including flow rate, velocity, and apron length, upstream and downstream widths, average stone diameter and depth.

# DOWNDRAIN PIPE AND INLET DETAIL

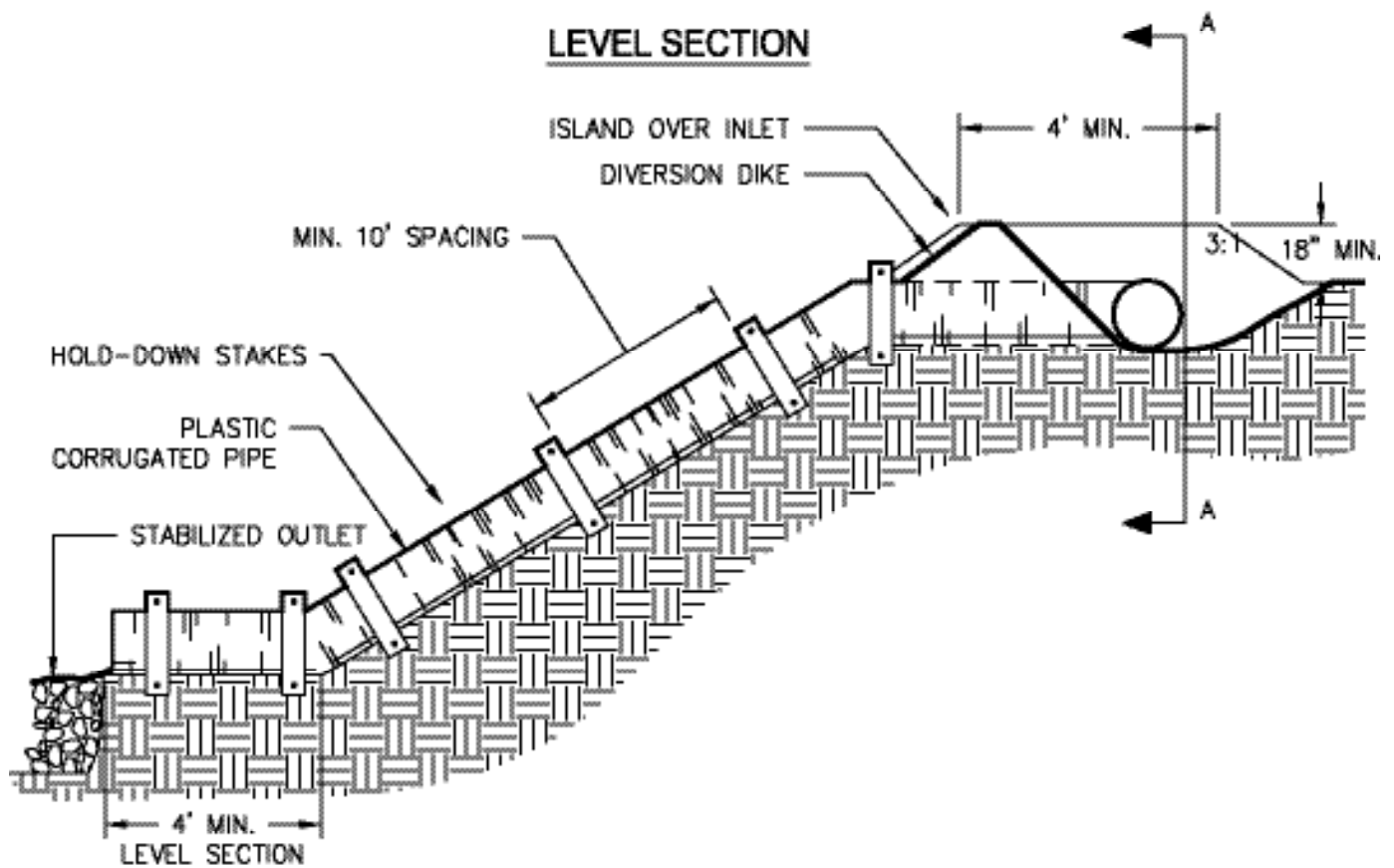

## INLET DETAIL SECTION A-A

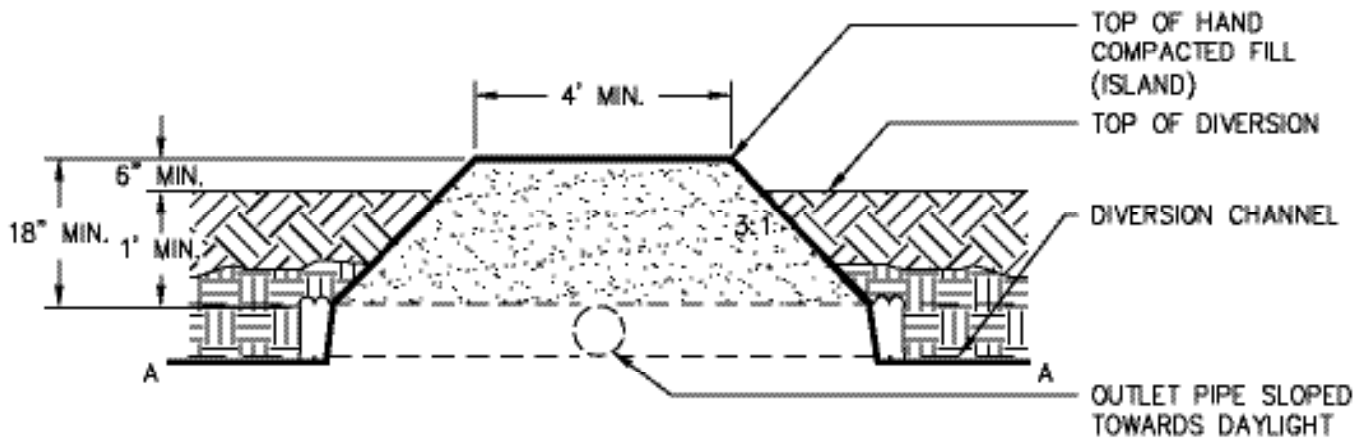

MAKE ALL PIPE CONNECTIONS WATERTIGHT AND SECURE SO THAT THE JOINTS WILL NOT SEPARATE IN USE.

Figure 6-18.1



# Permanent Downdrain Structure

Dn2



## DEFINITION

A permanent structure to safely convey surface runoff from the top of a slope to the bottom of the slope.

## PURPOSE

The purpose of this standard is to convey storm runoff safely down cut or fill slopes to minimize erosion.

## CONDITIONS

Several types of structures may be used as a permanent downdrain. All structures shall satisfy the standards and specification set forth by the Georgia Department of Transportation. The following types of structures may be used:

### Paved Flume

The paved flume may have a parabolic, rectangular or trapezoidal cross-section.

### Pipe

The pipe may be constructed of materials including steel, plastic, etc.

### Sectional

A prefabricated sectional conduit of half round or third round pipe may be used.

Downdrain structures are to be used where concentrated water will cause excessive erosion on cut and fill slopes.

## DESIGN CRITERIA

Permanent downdrain structures should be designed by professionals familiar with these structures.

## Capacity

Flumes shall be adequately designed to safely convey runoff water concentrations down steep slopes based on a minimum 25-year, 24-hour storm in accordance with criteria in Appendix A of this Manual.

## Slope

The slope shall be sufficient to prevent the deposition of sediment.

## Outlet Stabilization

Outlets must be stabilized using criteria in **St - Storm Drain Outlet Protection**.

## MAINTENANCE

Inspect for damage after each rainfall.



# Filter Ring

Fr



## DEFINITION

A temporary stone barrier constructed at storm drain inlets and pond outlets.

## PURPOSE

This structure reduces flow velocities, preventing the failure of other sediment control devices. It also helps prevent sediment from leaving the site or entering drainage systems, prior to permanent stabilization of the disturbed area.

## CONDITIONS

**Filter rings shall be used in conjunction with other sediment control measures**, except where other practices defined in this Manual are not appropriate (such as inlets to concrete flumes). They can be installed at or around devices such as inlet sediment traps, temporary downdrain inlets, and detention pond retrofits to provide additional sediment filtering capacity.

## DESIGN CRITERIA

Formal design is not required. The following standards shall be used:

### Location

The filter ring shall surround all sides of the structure receiving runoff from disturbed areas. It should be placed a minimum of four feet from the structure. The ring is not intended to substantially impound water, causing flooding or damage to adjacent areas.

The filter ring may also be placed below storm drains discharging into detention ponds, creating a centralized area, or “forebay”, for sediment accumulation. This provides for easier, more localized clean-out of the pond. If utilized above a retrofit

structure, it should be a minimum of 8 to 10 feet from the retrofit.

## Stone Size

When utilized at inlets with diameters less than 12 inches, the filter ring shall be constructed of stone no smaller than 3-5 inches (15 - 30 lbs.).

When utilized at pipes with diameters greater than 12 inches, the filter ring shall be constructed of stone no smaller than 10-15 inches (50 - 100 lbs.).

The larger stone can be faced with smaller filter stone on the upstream side for added sediment filtering capabilities. However, the smaller filter stone is more prone to clogging, requiring higher maintenance.

## Height

The filter ring shall be constructed at a height no less than two feet from grade.

## CONSTRUCTION SPECIFICATIONS

Mechanical or hand placement of stone shall be required to uniformly surround the structure to be supplemented. Refer to Appendix C for rock riprap specifications.

The filter ring may be constructed on natural ground surface, on an excavated surface, or on machine compacted fill.

A common failure of a filter ring is caused by placing it too close to or too high above the structure it is enhancing. When utilized below a storm drain outlet, it shall be placed such that it does not create a condition causing water to back-up into the storm drain and inhibit the function of the storm drain system.

## MAINTENANCE

The filter ring must be kept clear of trash and debris. This will require continuous monitoring and maintenance, which includes sediment removal when one-half full. Structures are temporary and should be removed when the land-disturbing project has been stabilized.

# STONE FILTER RING

## PERSPECTIVE VIEW

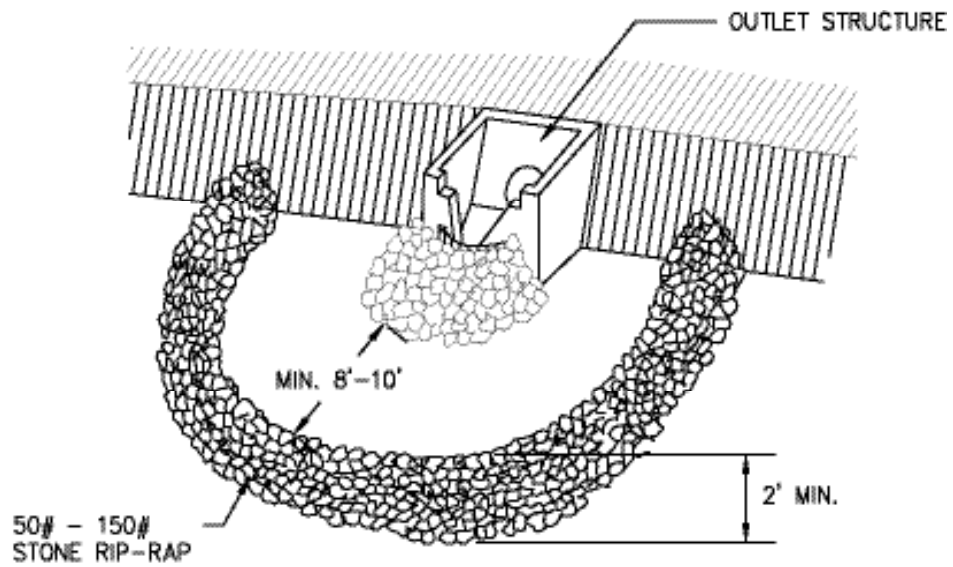

## PLAN VIEW (NOT TO SCALE)

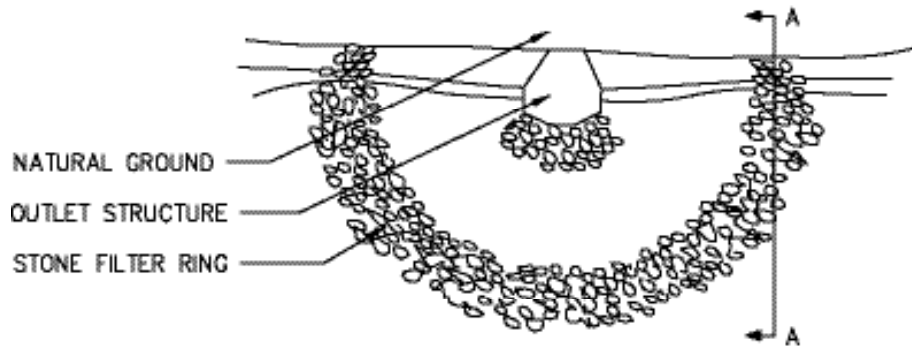

## CROSS SECTION (NOT TO SCALE)

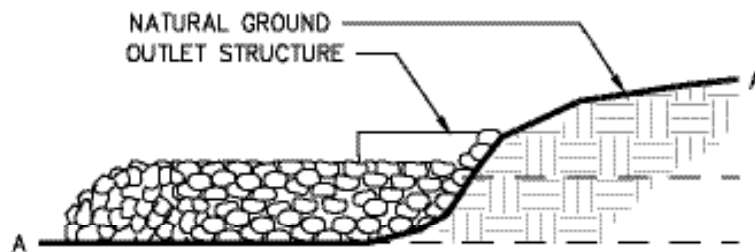

Figure 6-20.1

# Gabion

Ga



## DEFINITION

Gabions are large, multi-celled, welded wire or rectangular wire mesh boxes, used in channel revetments, retaining walls, abutments, check dams, etc.

## PURPOSE

Rock-filled baskets, properly wired together, form flexible monolithic building blocks used for construction of erosion control structures. Gabions are used to stabilize steep or highly erosive slopes.

## DESIGN CRITERIA

Construction plans and drawings should be prepared by professionals familiar with the use of gabions. Erosion and sediment control construction design should ensure that foundations are properly prepared to receive gabions, that the gabion structure is securely “keyed” into the foundations and abutment surfaces, and that rock used is durable and adequately sized to be retained in the baskets.

## CONSTRUCTION SPECIFICATIONS

### How the Gabion is Filled

The gabion is usually filled with 4 - 8 inch pieces of stone, preferably placed by hand, but sometimes dumped mechanically, into the basket. Hand-packing allows the complete filling of the basket; allowing the basket to gain strength and maintain its integrity. The filled gabion then becomes a large, flexible, and permeable building block from which a broad range of structures may be built. This is done by setting and wiring individual units together in courses and filling them in place. Details are provided by the manufacturer.

## Geotextiles

It is recommended that geotextiles be used behind all gabion structures. Geotextiles shall be specified in accordance with AASHTO M288-96 Section 7.5, *Permanent Erosion Control Requirements*.

If there is seepage flow or unidirectional flow from the protected soil mass, the appropriate geotextile should be selected based on an appropriate filter design to prevent the build-up of hydrostatic pressure behind the geotextile.

## Corrosion Resistance of Gabions

The wire mesh or welded wire used in gabions is heavily galvanized. For highly corrosive conditions, a PVC (polyvinyl chloride) coating must be used over the galvanizing. Such treatment is an economical solution to deterioration of the wire near the ocean, in some industrial areas, in polluted streams, and in soils such as muck and peat. However, extra care should be taken during construction and installation because the corrosion resistance of the baskets is compromised if the PVC coating is chipped-off. Also, baskets manufactured completely of plastic are available.

## Flexibility

An outstanding advantage of the gabion is its flexibility of application. This property is especially important when a structure is on unstable ground or in areas where scour from waves or currents can undermine it.

## Durability

Gabions are durable because they support plant growth that develops a living coating for the wire mesh and stones. After the first few years, the strength of the structure may be enhanced by the soil, silt, and roots that fill the voids between the individual stones.

## Strength

Steel wire baskets have the strength and flexibility to withstand forces generated by water and earth masses. Also, the pervious nature of the gabion allows it to absorb and dissipate much of the energy developed. This is particularly so on coast protection installations where a compact gabion structure often remains long after a massive rigid structure fails.



## Permeability

Hydrostatic heads do not develop behind a gabion wall. The wall is pervious to water and stabilizes a slope by the combined action of draining and retaining. Drainage is accomplished by gravity and by evaporation as the porous structure permits active air circulation through it. Moreover, as plant growth invades the structure, transpiration further assists in removing moisture from the backfill. This system is much more efficient than weep holes in standard masonry walls.

## Economy

Gabion installations are more economical than rigid or semi-rigid structures for a number of reasons. The following are among the more important ones.

- Little maintenance is required.
- Gabion construction is simple and does not require skilled labor.
- Preliminary foundation preparation is unnecessary; the surface needs only to be reasonably level and smooth.
- No costly drainage provision is required because of the gabion's porosity.

## Landscaping

Because gabions permit the growth of natural vegetation and maintain the natural environment of the area, they provide attractive and natural building blocks for decorative landscaping.

They can be used effectively and economically in parks, along highways, including use as a sound barrier, and around bridge approaches to create walkways, rock gardens, patios, and terraces, to beautify the banks of lakes and ponds, to accent trees and other plantings.

In fact, their application to decorative landscaping is limited only by the ingenuity of the landscaper.

## Typical Installations

- Flood control:
  - Gabion aprons
  - Longitudinal works
  - Drop structures or weirs
  - Spurs, spur dikes, or groins
  - Counterforts
  - Training walls
  - Revetments
  - Bank paving

- Channel linings
- Retaining walls
- Bridge abutments and wings
- Marinas and boat ramps
- Culvert headwalls and outlet aprons
- Shore and beach protection

## MAINTENANCE

Periodic inspection should be performed for signs of undercutting or excessive erosion at transition areas.

Source: National Crushed Stone Association

# Grade Stabilization Structure

Gr

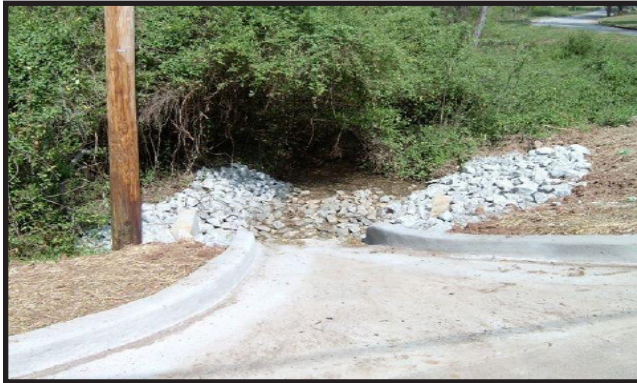

## DEFINITION

A structure to stabilize the grade in natural or artificial channels.

## PURPOSE

Grade stabilization structures are installed to stabilize the grade in natural or artificial channels, prevent the formation or advance of gullies, and reduce erosion and sediment pollution.

## CONDITIONS

This standard applies to sites where structures are needed to stabilize channel grades but does not apply to sites where water is to be impounded.

## DESIGN CRITERIA

### Structures

Structures constructed of concrete, rock, masonry, steel, aluminum or treated wood or by soil bioengineering methods shall be designed in accordance with sound engineering practices. Design data for small reinforced concrete drop spillways and formless concrete chute spillways are contained herein.

Geotextile should be placed under stabilization structures such as revetment mats and riprap as part of a permanent erosion control system. The geotextile should be selected/specified in accordance with AASHTO M288-96 Section 7.5, *Permanent Erosion Control*.

### Capacity

The condition of adjacent areas is considered when determining the storm frequency used to design the grade stabilization structure. Structures shall be designed to protect areas from

overbank flow damage up to and including storm frequencies specified in Table 6-22.1.

Adjacent Area	Storm Frequency
Residences, commercial buildings, recreational buildings, etc.	100 - year, 24 - hour storm
Recreation and landscaped areas	25 - year <sup>2</sup> , 24 - hour storm <sup>1</sup>
Agricultural land	25 - year <sup>2</sup> , 24 - hour storm <sup>1</sup>

<sup>1</sup> 50 percent of peak flood flow may be carried around island-type structures provided overbank flow damage from erosion and flooding can be tolerated. Peak flood flow will be determined by methods contained in Appendix A.

<sup>2</sup> Or the storm frequency specified in Title 12 of the Official Code of Georgia Annotated.

## Embankment

Earthfill embankments shall have a minimum top width of 10 feet and side slopes of 3:1 or flatter.

## Keyway

A keyway no less than 8 feet wide and 2 feet deep shall be constructed along the centerline of the structure and embankment.

## Outlet

All structures shall discharge into stable outlets.

## CONSTRUCTION SPECIFICATIONS

Excavations shall be dewatered prior to filling.

Structures shall be placed on compacted earth-fill. Earthfill material shall be moderately to slowly permeable with the most plastic being used in the center of the embankment and adjacent to structures. Materials shall be constructed in 6 - 8 inch horizontal lifts and compacted to approximately 95% of standard density. The embankment shall be overbuilt 10% in height to allow for settlement. Embankment surfaces shall be completed to the required lines and grades.

Protective cover shall be applied immediately

after completion of the structure. Refer to specifications **Ds3** and **Ds4 - Disturbed Area Stabilization (With Permanent Vegetation and Sodding)**, respectively, and **Ss - Slope Stabilization**.

		DISCHARGE (cfs)								
		10	25	50	100	150	200	400	800	1500
CONTROLLED HEAD (feet)	4	Drop spillways or Hooded inlet spillways				Drop spillways				
	8	Drop spillways or Hooded inlet spillways				Drop spillways				
	12	Drop spillways or Hooded inlet spillways				Drop spillways				Drop or chute spillways
	16	Hooded inlet or Pipe drop inlet spillways				Drop spillways				Drop or chute spillways
	20	Hooded inlet or Pipe drop inlet spillways				Monolithic drop inlet spillways				Chute spillways
	25	Hooded inlet or Pipe drop inlet spillways				Monolithic drop inlet spillways				Chute spillways
	30	Hooded inlet or Pipe drop inlet spillways				Monolithic drop inlet spillways				Chute spillways
	40	Pipe drop inlet spillways				Monolithic drop inlet spillways				Chute spillways
	80	Pipe drop inlet spillways				Monolithic drop inlet spillways				Chute spillways

Note: Chart shows most economical structure as related to discharge and controlled head providing site conditions are adequate.

Figure 6-22.1

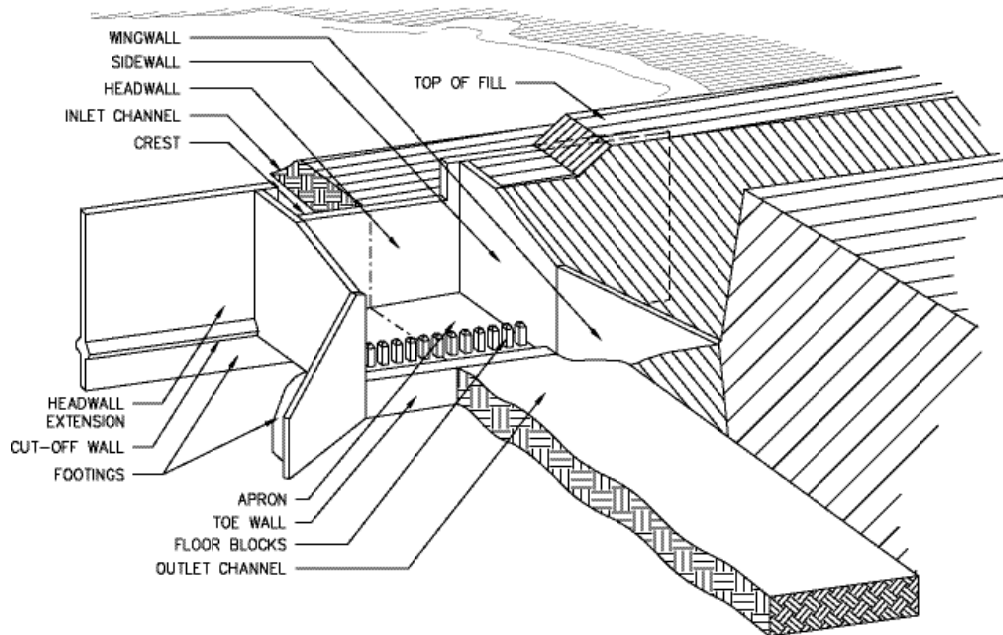

Figure 6-22.2

Planning and design of straight drop spillways normally require the assistance of an engineer. Local personnel may be trained to plan and install small drop spillway structures when standard plans are available.

Measurement locations for symbols  $F$  (overfall in feet),  $h$  (depth of weir in feet),  $s$  (depth of stilling pool in feet), and  $L$  (length of weir in feet) are shown in Figure 6-16.3

# STRAIGHT DROP SPILLWAY

## DOWNSTREAM ELEVATION

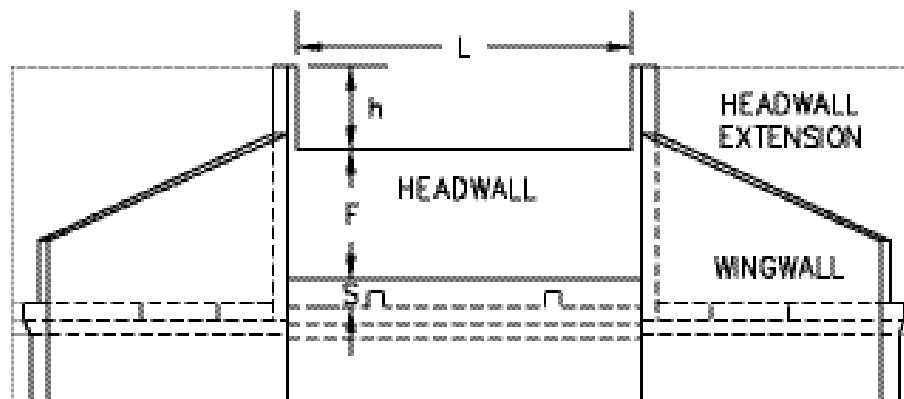
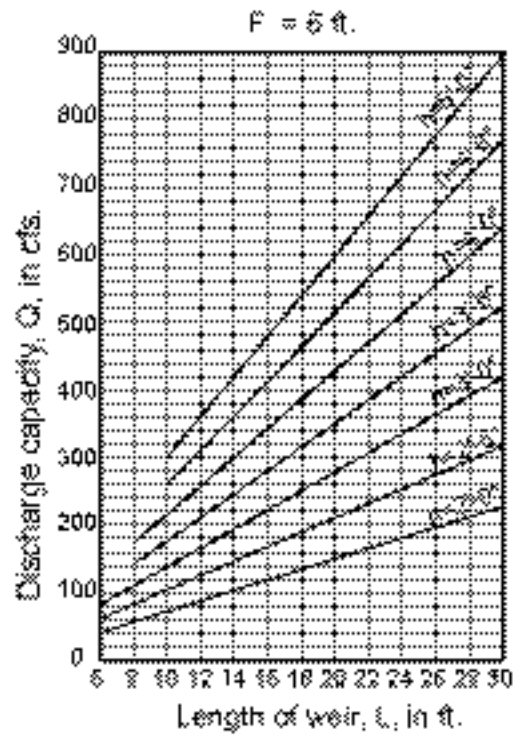
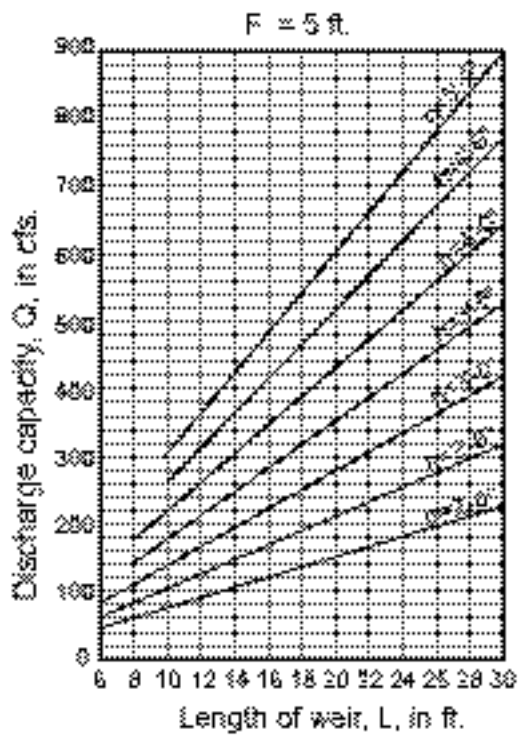
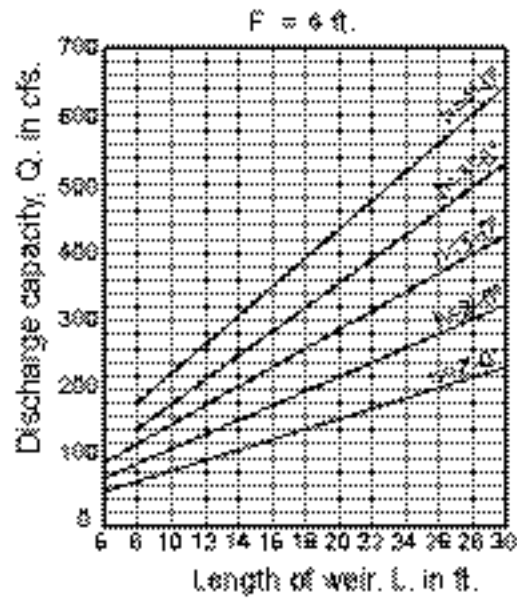
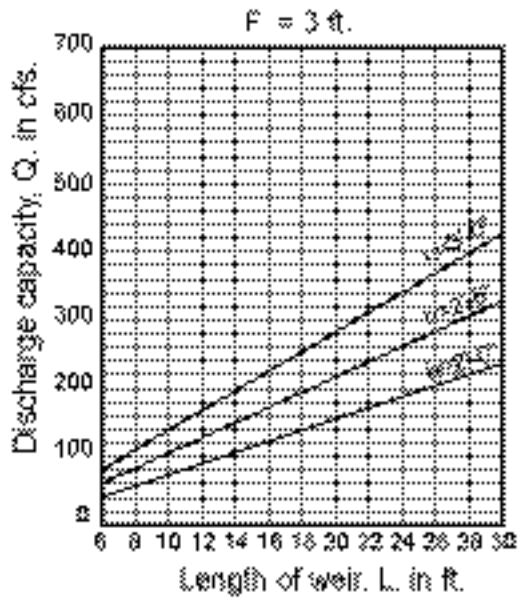

Figure 6-22.3 - Symbols For Straight Drop Spillway

Weir capacities for low-overall straight drop spillways can be determined from figure 6-23.4 for various combinations of  $F$ ,  $h$ , and  $L$ .



Note: h = total depth of weir, in feet (including freeboard)  
 c = net drop from crest to top of transverse sill, in feet  
 (For type B drops keep h + F less than 0.75)

$$Q = \frac{3.11L^{3/2}}{(1.58 + 0.01F)}$$

## WEIR CAPACITY FOR STRAIGHT DROP SPILLWAYS

Figure 6-22.4

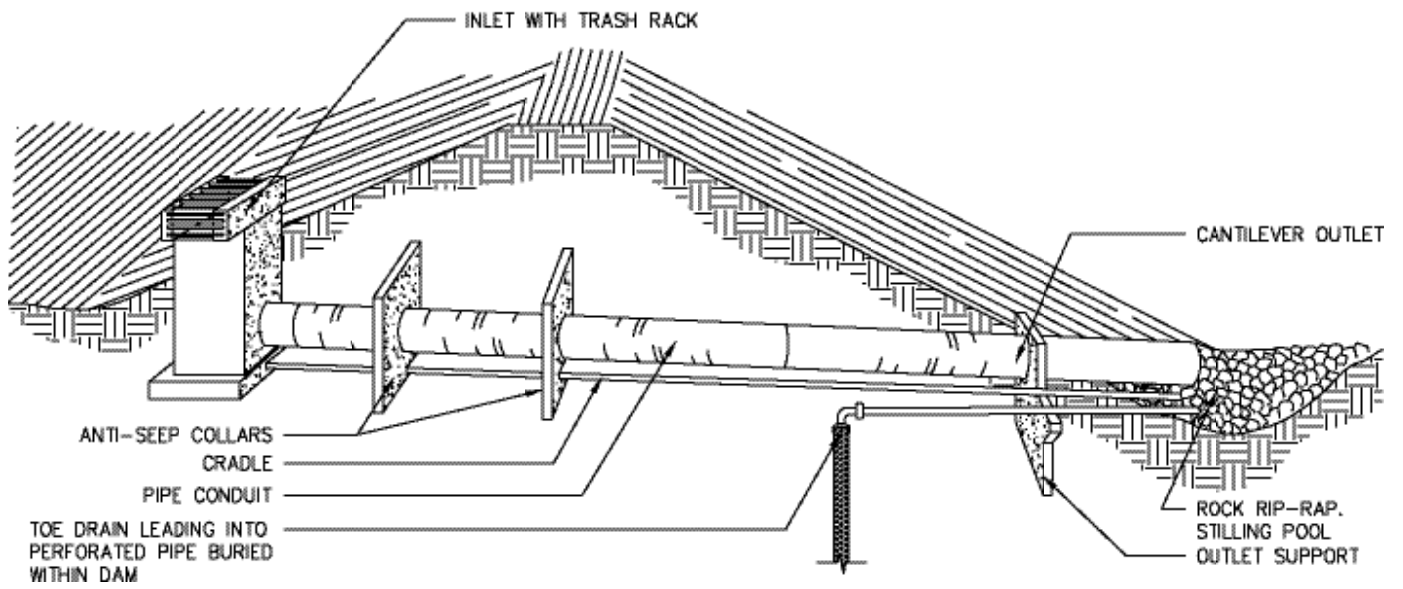

Figure 6-22.5 Drop Inlet Spillway

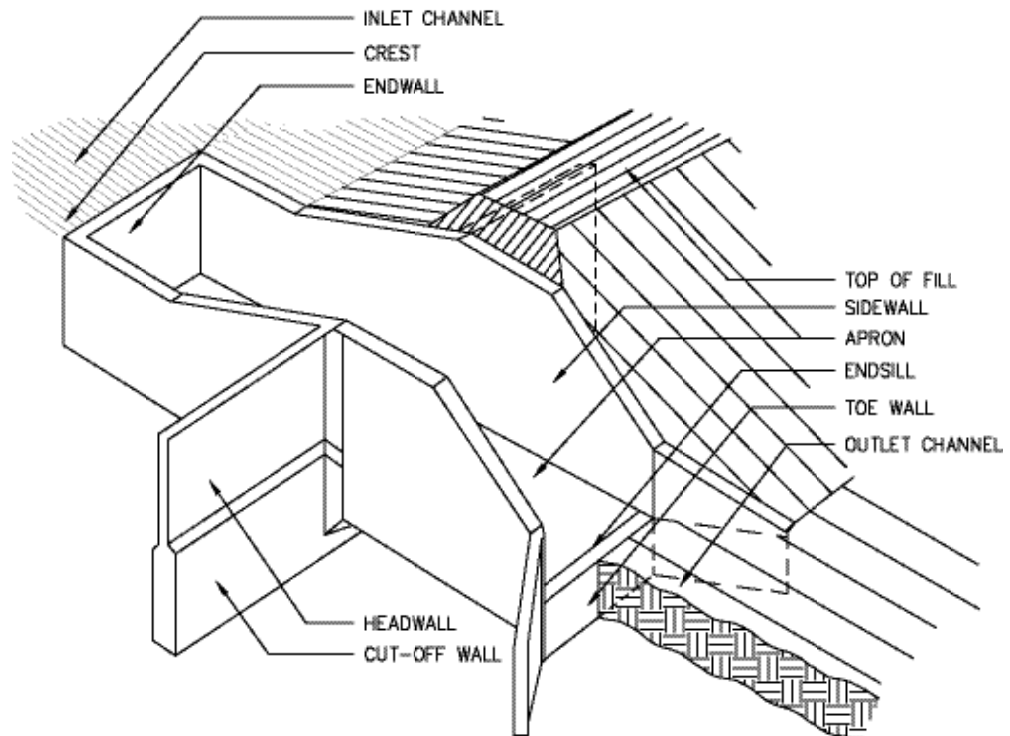

Figure 6-22.6 Box Drop Inlet Spillway

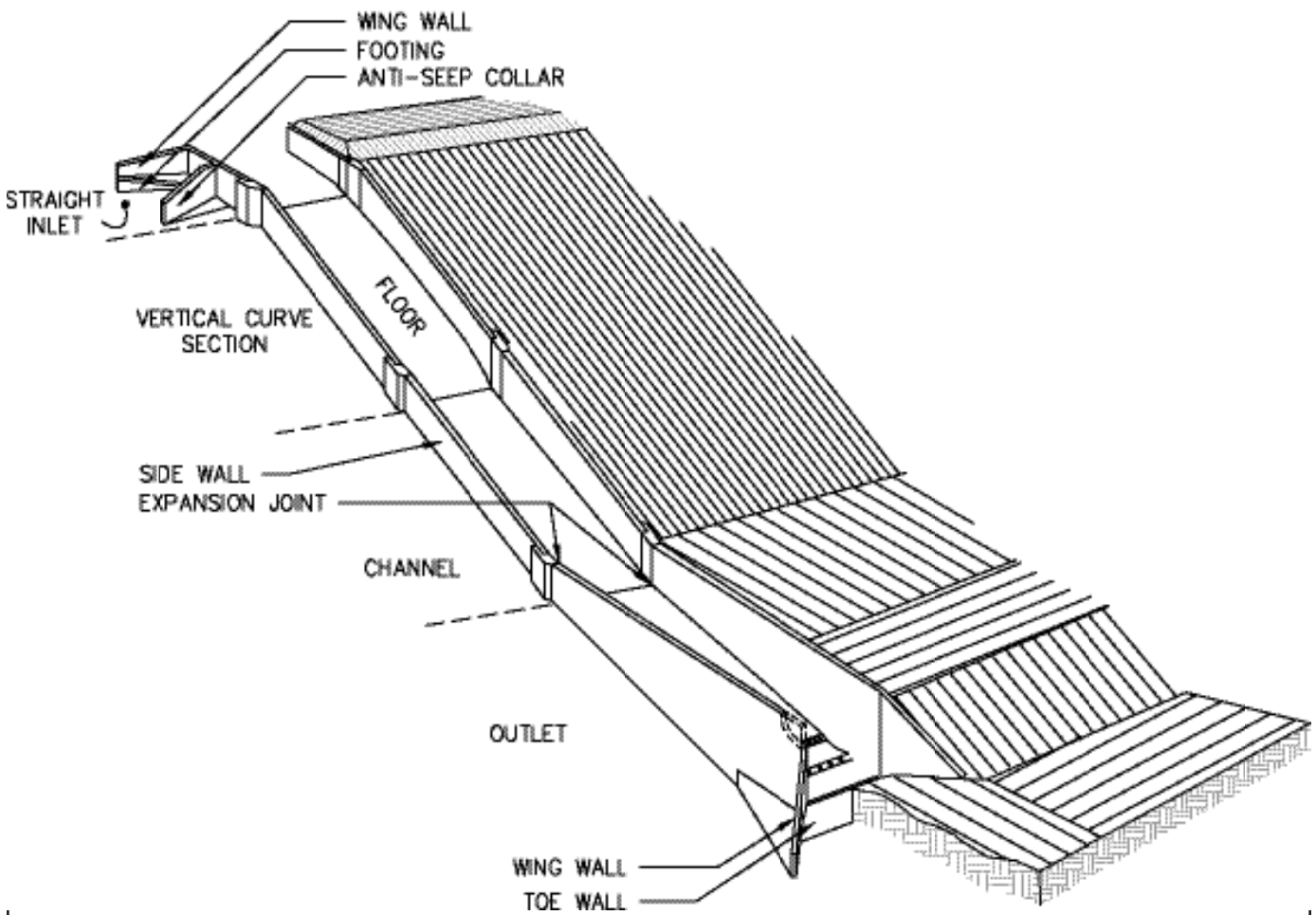
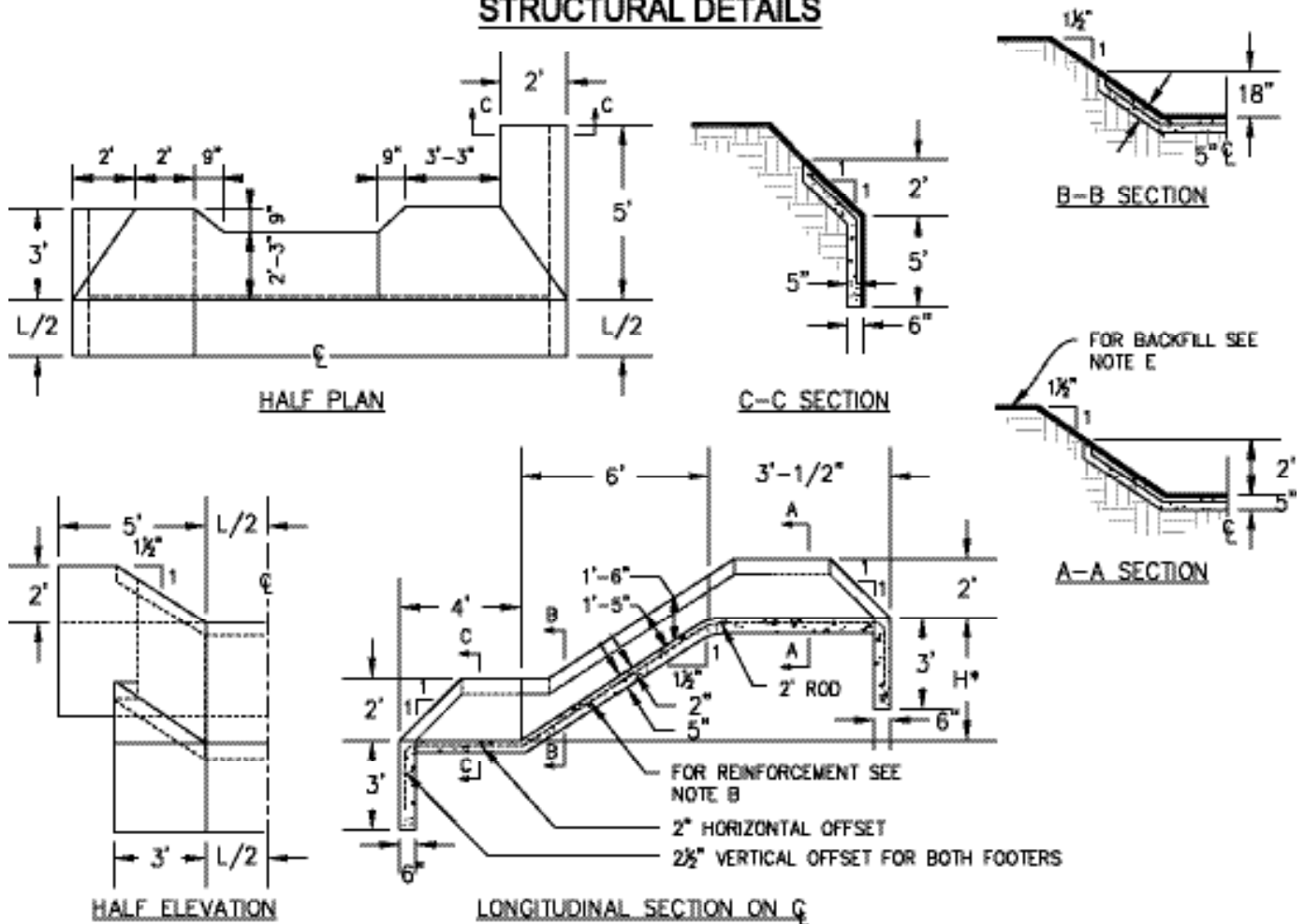

Figure 6-22.7 Chute Spillway

# TYPICAL PLAN - FORMLESS CONCRETE CHUTE

## STRUCTURAL DETAILS



### NOTES:

- USE 5 INCH THICKNESS OF CONCRETE THROUGHOUT EXCEPT AS DIMENSIONED OTHERWISE.
- REINFORCING AS INDICATED SHALL BE (1)  $\frac{3}{8}$ "  $\phi$  REINFORCING STEEL 12" O.C. BOTH WAYS; (2) NO. 2 GAUGE WELDED WIRE FABRIC 6" O.C. BOTH WAYS (COMMON DESIGNATION 6X6 2/2). REINFORCING BARS OR MESH SHOULD BE LAPPED ONE FOOT AT ALL JOINTS.
- SPILLWAYS OF THIS TYPE SHALL BE CONSTRUCTED ON SOLID GROUND. SEEP AREAS SHOULD BE AVOIDED OR PROPERLY DRAINED WITH A CAREFULLY CONSTRUCTED TOE DRAINAGE SYSTEM.
- THIS SPILLWAY SHALL NOT BE USED AS A PART OF A WATER IMPOUNDING STRUCTURE.
- THE DISTURBED AREA ADJACENT TO THE SPILLWAY SHALL BE BACKFILLED, COMPACTED, AND SODDED.
- THE LENGTH (L) OF THE SPILLWAY SHALL BE LIMITED BY THE AMOUNT OF CONCRETE THAT CAN BE ADEQUATELY MIXED, PLACED, AND FINISHED IN ONE DAY'S TIME WITH THE LABOR AND EQUIPMENT AVAILABLE OR A MAX.  $L=8'-0"$ .
- THE MAXIMUM "H" FOR THIS SPILLWAY IS  $5'-0"$ .

DISCHARGE CAPACITY OF SPILLWAY IN C.F.S.				
LENGTH OF CREST (L) IN FEET	2	4	6	8
(L) WITH NO FREEBOARD	30	45	60	75
(L) WITH 6" FREEBOARD	18	28	38	48

CONCRETE VOLUMES IN CUBIC YARDS				
HEAD "H" IN FEET	LENGTH OF CREST (L) IN FEET			
	2' - 0"	4' - 0"	6' - 0"	8' - 0"
4' - 0"	3.5	4.2	4.9	5.6
5' - 0"	3.7	4.4	5.2	6.0

Figure 6-22.8 Typical Plan - Formless Concrete Chute



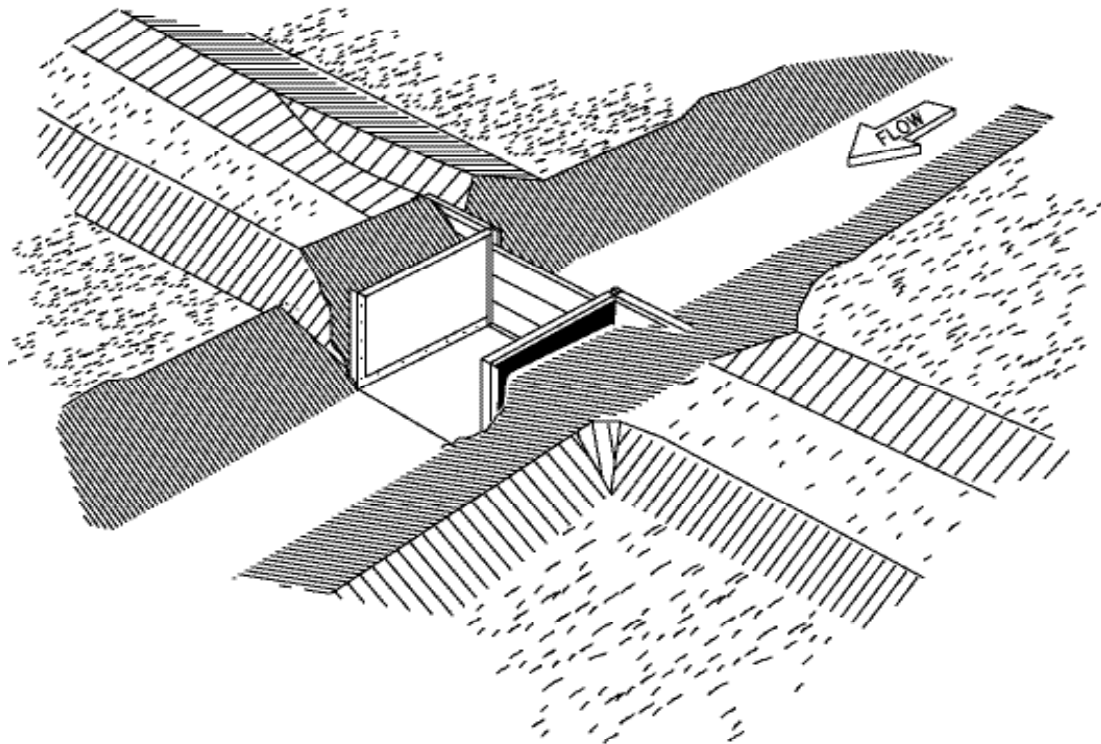

Figure 6-22.9 Prefabricated Metal Structure

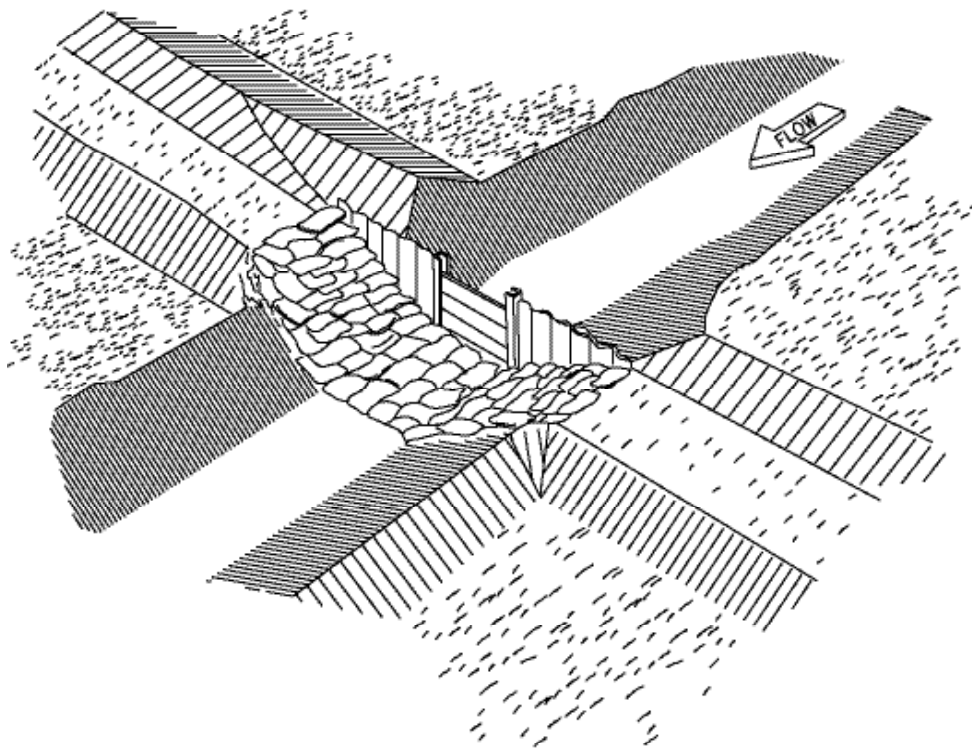
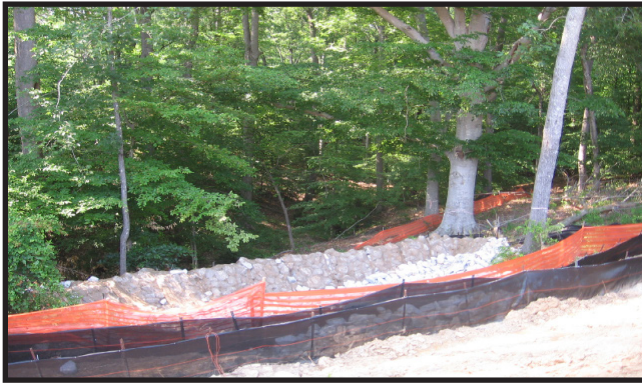

Figure 6-22.10 Sheet Piling Headwall with Sand -Cement Bag Sidewalls and Apron

**SMALL, LOW COST WATER CONTROL STRUCTURES**

# Level Spreader

Lv



## DEFINITION

A storm flow outlet device constructed at zero grade across the slope whereby concentrated runoff may be discharged at non-erosive velocities onto undisturbed areas stabilized by existing vegetation.

## PURPOSE

To dissipate storm flow energy at the outlet by converting storm runoff into sheet flow and to discharge it onto areas stabilized by existing vegetation without causing erosion.

## CONDITIONS

Where sediment-free storm runoff is intercepted and diverted onto undisturbed stabilized areas (*i.e.*, at diversion outlets, etc.). This practice applies only in those situations where the spreader can be constructed on undisturbed soil and where the area directly below the level lip is stabilized by existing vegetation. The water must not be allowed to reconcentrate below the point of discharge.

## DESIGN CRITERIA

### Length

A specific design for level spreaders will not be required. However, spreader length will be determined by estimating the peak stormflow from the 10-year, 24-hour storm or the storm specified in Title 12 of the Official Code of Georgia Annotated and selecting the appropriate length from Table 6-23.1.

### Outlets

Final discharge will be over the level lip onto an undisturbed, stabilized area. The outlet shall be generally smooth to create uniform sheet flow.

**Table 6-23.1**

Designed Q <sub>10/24</sub> (cfs)	Minimum Length "L" (feet)
up to 10	10
11 to 20	20
21 to 30	30
31 to 40	40
41 to 50	50

## CONSTRUCTION SPECIFICATIONS

The minimum acceptable width shall be 6 feet. The depth of the level spreader as measured from the lip shall be at least 6 inches and the depth shall be uniform across the entire length of the measure.

The grade of the channel for the last 15 feet of the dike or diversion entering the level spreader shall be less than or equal to 1%.

The level lip shall be constructed on zero percent grade to insure uniform spreading of storm runoff (converting channel flow to sheet flow). For calculation purposes, a grade of 0.1% may be needed, however, the level spreader shall be installed at zero percent grade.

**Level spreaders must be constructed on undisturbed soil (not on fill).**

The entrance to spreader shall be graded in a manner to insure that runoff enters directly onto the zero percent graded channel.

Storm runoff converted to sheet flow must discharge onto undisturbed stabilized areas.

All disturbed areas shall be vegetated immediately after construction is completed. Refer to specifications **Ds3** and **Ds4 - Disturbed Area Stabilization (With Permanent Vegetation and Sodding)**, respectively and **Ss - Slope Stabilization**.

## MAINTENANCE

Periodic inspection and maintenance must be provided.

# LEVEL SPREADER

## PLAN

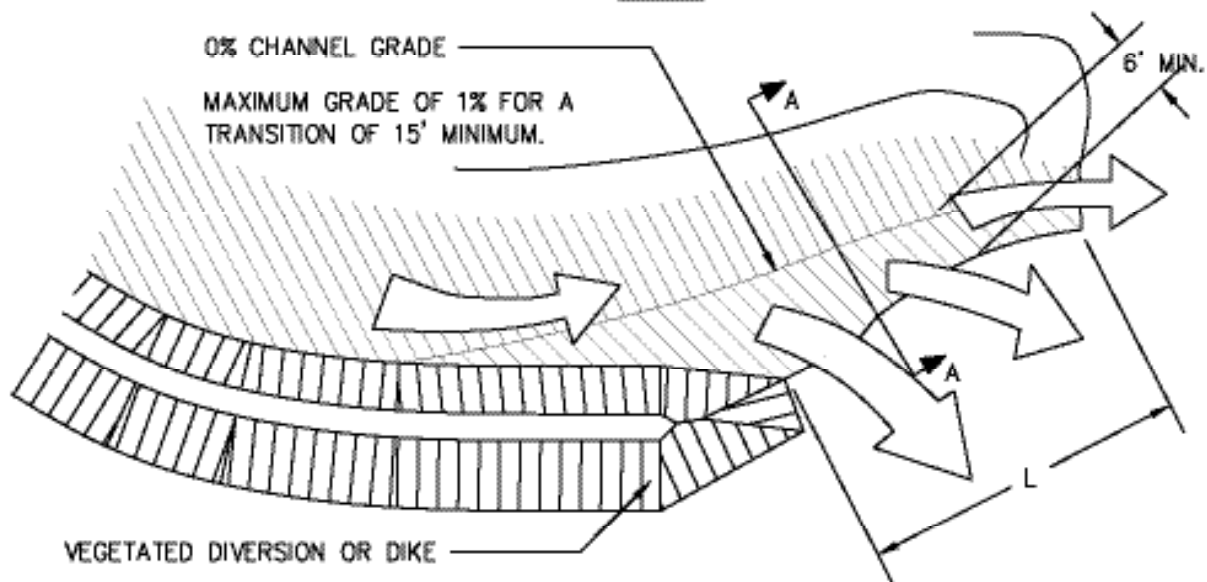

## SECTION A-A

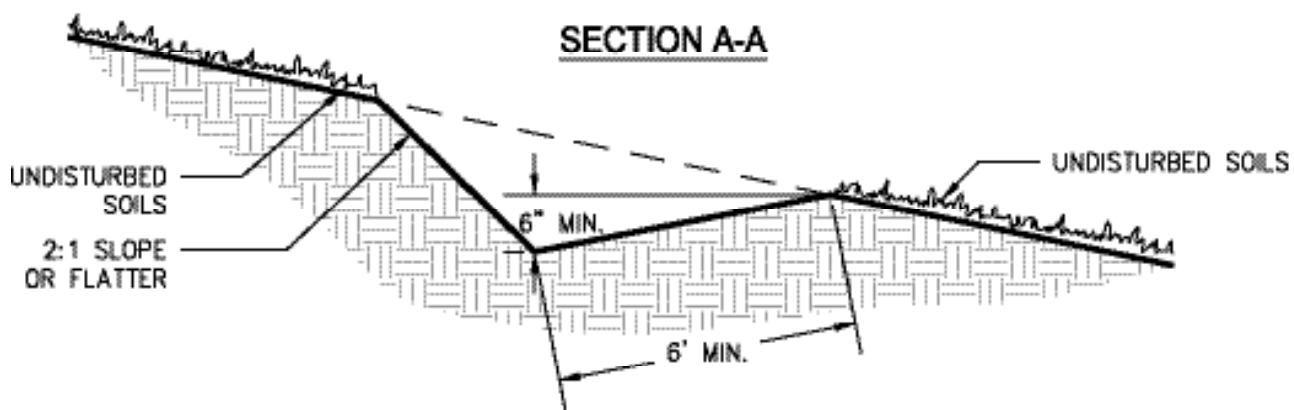

## ISOMETRIC VIEW - NOT TO SCALE

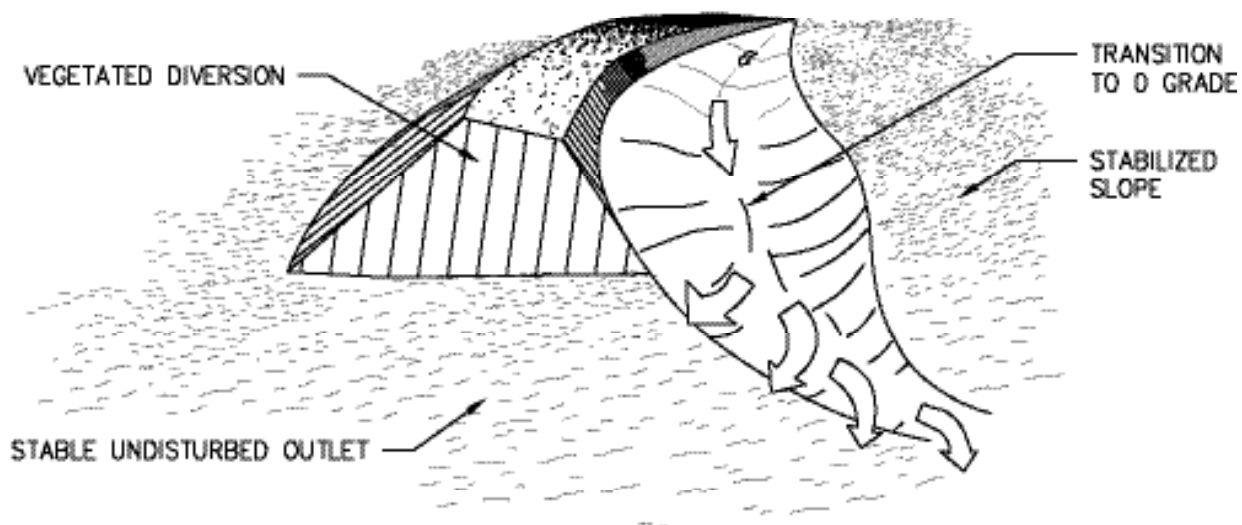

Figure 6-23.1

# Rock Filter Dam

Rd



## DEFINITION

A temporary stone filter dam installed across drainageways or in conjunction with a temporary sediment trap.

## PURPOSE

This structure is installed to serve as a sediment filtering device in drainageways or outlets for sediment traps (**See Temporary Sediment Trap - Sd4**). In some cases, it may also reduce the velocity of stormwater flow through a channel. This structure is not intended to substantially impound water.

## CONDITIONS

This practice is applicable for use in small channels that drain 50 acres or less. The rock filter dam must be used in conjunction with other appropriate sediment control measures to reduce the amount of sediment leaving the channel.

## DESIGN CRITERIA

The following standards shall be followed:

### Drainage Area

The drainage area to the dam shall not exceed 50 acres.

### Height

The dam should not be higher than the channel banks or exceed the elevation of the upstream property line. The center of the rock dam should be at least nine inches lower than the outer edges of the dam at the channel banks.

### Side Slopes

The side slopes shall be 2:1 or flatter.

## Location

The dam shall be located as close to the source of sediment as possible and so that it will not cause water to back up on upstream adjacent property or into state waters.

## Stone Size

The stone size shall be determined by the design criteria established in **Riprap - Appendix C**. The rock dam can be faced with smaller stone on the upstream side for additional filtering effect. However, this may make the dam more prone to clogging.

## Top Width

The width across the top of the dam should be no less than six feet.

## Geotextile

Geotextiles should be used as a separator between the graded stone, the soil base, and the abutments. The geotextile will prevent the migration of soil particles from the subgrade into the graded stone. The geotextile shall be specified in accordance with AASHTO M288-96 Section 7.5, *Permanent Erosion Control Recommendations*. The geotextile should be placed immediately adjacent to the subgrade without any voids and extend five feet beyond the downstream toe of the dam to prevent scour.

## CONSTRUCTION SPECIFICATIONS

Mechanical or hand placement will be required to insure that the rock dam extends completely across the channel and securely ties into both channel banks. The center of the dam must be no less than nine inches lower than the lowest side, to serve as a type of weir. Gabions can be installed to serve as rock filter dams, but should follow recommended sizing and installation specifications. Refer to specification **Ga - Gabion**. See Figure 6-24.1

## MAINTENANCE

Rock dams should be removed once disturbed areas have been stabilized. Periodic inspection and required maintenance must be provided. Sediment shall be removed when it reaches a depth of one-half of the original height of the dam.

**TO BE SHOWN ON THE EROSION AND SEDIMENT CONTROL PLAN**

1. **Figure 6-24.1**, noting rock size as specified in Appendix C.
2. Top and bottom widths.

# ROCK FILTER DAM

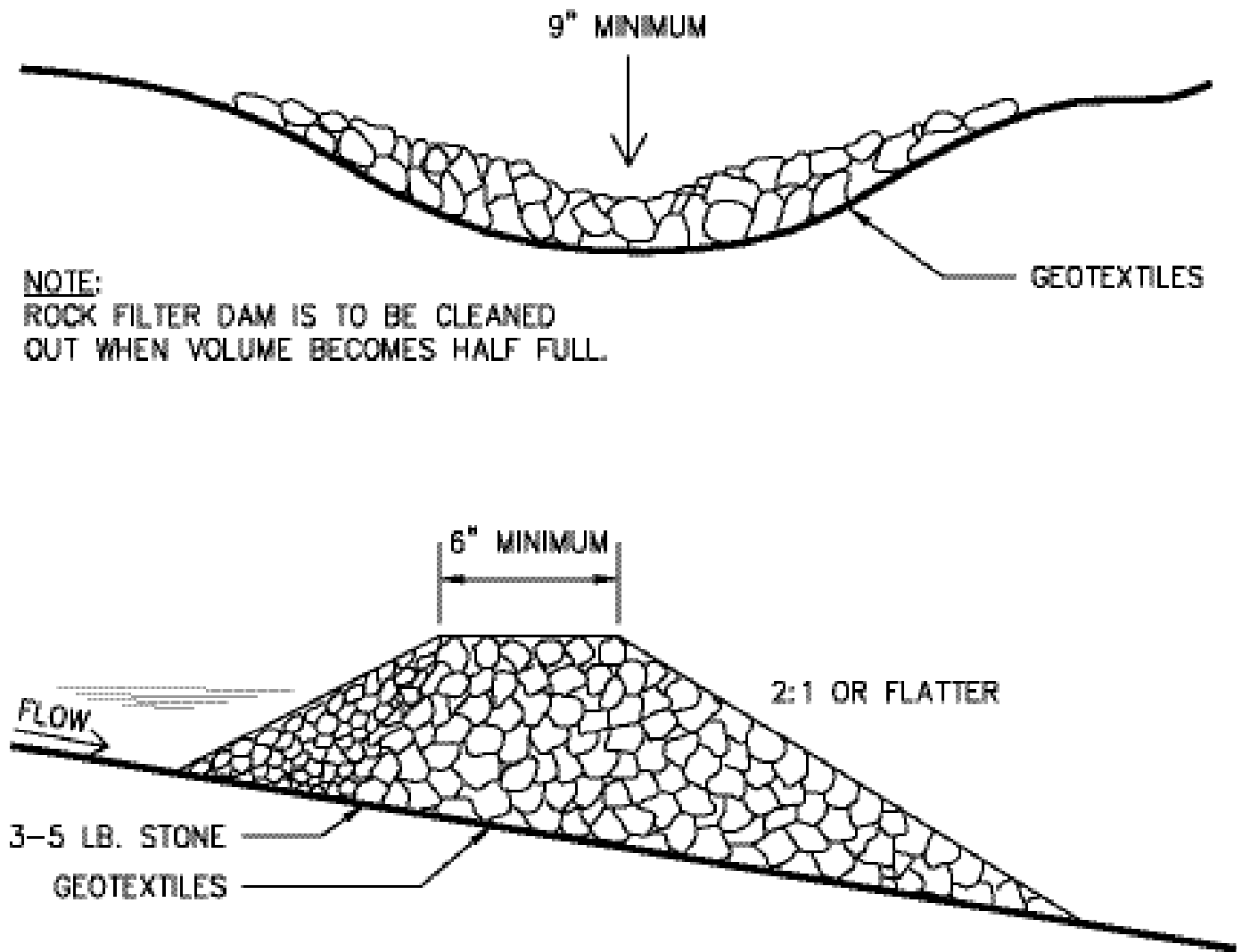

**NOTE:**  
ROCK SIZE DETERMINED ACCORDING TO  
SPECIFICATIONS SET FORTH IN APPENDIX C.

Figure 6-24.1



# Retaining Wall

Re



## DEFINITION

A wall constructed of one or more of the following: concrete masonry, reinforced concrete cribbing, treated timbers, steel pilings, gabions, stone drywall, rock riprap, etc.

## PURPOSE

To assist in the stabilization of cut or fill slopes where stable slopes are not attainable without the use of the wall.

## CONDITIONS

Use in conjunction with cut or fill slopes that, because of space limitations or unstable material, do not allow the stable slope criteria listed above, e.g. cuts into steep hillsides on small lots or cuts into hillsides behind shopping centers to provide loading space.

## DESIGN CRITERIA

### General

The design of a retaining wall is a complicated process. Many factors must be taken into account such as: stresses and forces outside and within the wall, allowable height and minimum thickness. Other considerations are: foundation design with respect to loadings, bearing values of soils and footing dimensions. Additional design factors are safety hazards, subsurface and surface drainage and appearance.

Each situation requires a *specific design* that is within the capabilities of the design professional.

Consideration should be given to all of the alternative methods with regard to construction of the

wall. Some methods are:

1. Concrete masonry
2. Concrete cribbing
3. Gabions
4. Steel piling
5. Stone drywall
6. Rock riprap, etc.
7. Treated timbers
8. Geotextile wrapped-face wall
9. Geotextile reinforced steep slopes





# Retrofitting

Rt



## DEFINITION

A device or structure placed in front of a permanent stormwater detention pond outlet or roadway drainage structure to serve as a temporary sediment filter.

## PURPOSE

Allows permanent stormwater detention basin structures to function as temporary sediment retention basins for land-disturbing projects, and allow roadway drainage to be used for temporary sediment storage.

## CONDITIONS

This standard applies under the following conditions:

1. **Shall not be used in basins on live streams** or in basins with a total contributing drainage area of 100 acres or more.
2. Shall only be used in basins large enough to store 67 cubic yards of sediment per acre of disturbed area in the project.
3. Shall be considered a temporary structure and will be removed as soon as project is permanently stabilized. All accumulated sediment shall be removed, and the pond or basin shall be brought to final grade (if possible), prior to the removal of the retrofit.

## DESIGN CRITERIA

1. The height of the retrofit should be approximately one-half the height of the structure.
2. **A retrofitted detention pond must be capable of storing the required volume**

**of sediment in addition to the required stormwater volume.** The required sediment storage volume shall be achieved by either excavating the basin or raising the outlet structure's invert to achieve 67 cubic yards per acre of sediment storage. Remove sediment when one-third of the sediment storage capacity, not total pond capacity, is lost to sediment accumulation. This volume shall be marked on the riser or by setting a marked post near the riser.

3. For effective trapping efficiency, the sediment delivery inlets should be at the upper end of the basin.
4. For effective trapping efficiency, the length-width ratio of the basin shall be at least 2:1. If the length-width ratio is not at least 2:1, the flow length shall be increased with the use of baffles installed within the basin.

## CONSTRUCTION SPECIFICATIONS

The following types of structures are acceptable under the designated conditions:

### Perforated Half-Round Pipe with Stone Filter

(See Figure 6-26.1)

Rt -P

- a. Should be used only in detention ponds with less than 30 acre total drainage area.
- b. Never to be used on exposed pipe end or winged headwall.
- c. Diameter of half-round pipe should be 1.5 times the diameter of the principal pipe outlet or wider than the greatest width of the concrete weir.
- d. Perforations and stone sizes are shown in Figure 6-26.1.
- e. Shall be affixed by specified means (bolts, etc) to concrete outlet structure.

### Slotted Board Dam with Stone or Filter Fabric

Rt -B

(See Figure 6-26.3)

- a. Can be used in detention ponds with drainage areas up to 100 acres, and on roadway-drainage structures with drainage areas less than 30 acres.
- b. Can be used with open end pipe outlets, winged headwalls, or concrete weir outlets.
- c. Should be installed with minimum size 4x4 inch posts.
- d. Boards should have 0.5-1.0 inch space between them.
- e. Minimum size 3-4 inch stone filter or approved filter fabric shall be installed around the upstream side of the board dam.



Example of Slotted Board Dam

### Silt Control Gate

(See figure 6-26.3, 6-26.4, 6-26.5)

Rt -Sg

The silt control gate may be used for temporary sediment storage on linear construction projects including roadway construction or maintenance, and utility line installation. The following specifications shall apply:

- a. Shall only be used on roadway drainage structures with the following inlets: winged headwalls, tapered headwalls, straight headwalls, open end pipes, or flared end sections.
- b. Drainage area to the silt control gate shall not exceed 50 acres, and the disturbed area of the basin shall not exceed 5 acres.
- c. Post shall be 4"x4" treated lumber, and face boards shall be 2"x6" treated lumber with no

spacing allowed between the boards.

- d. An approved silt fence fabric shall be securely fastened to the front of the structure using staples or nails.
- e. Sediment shall be removed and properly disposed of when it reaches one-third the height of the silt gate. Filter fabric shall be replaced when damaged or deteriorated.
- f. Silt control gates should not be used as perimeter control alone, but instead be part of a treatment train that allows the drainage structure to discharge through another barrier before leaving the project.

All disturbed areas shall be vegetated immediately after construction with permanent vegetation. Refer to **Ds3** and **Ds4 - Disturbed Area Stabilization (With Permanent Vegetation)** and **Disturbed Area Stabilization (With Sodding)** and **Ss- Slope Stabilization**.

### MAINTENANCE

Retrofit structures shall be kept clear of trash and debris. This will require continuous monitoring and maintenance, which includes sediment removal when one-third of the sediment storage capacity has been lost. *Structures are temporary and shall be removed when disturbed areas have been permanently stabilized.*

## TO BE SHOWN ON THE EROSION AND SEDIMENT CONTROL PLAN

### Storage Calculations

1. Required stormwater storage = \_\_\_\_\_ cy  
(as determined by local ordinance)
2. Required sediment storage = \_\_\_\_\_ cy  
(67 cy/ac \* \_\_\_\_\_ ac disturbed area)
3. Total required storage = (1) + (2) = (3) cy
4. Available storage = (4) cy
5. Is the available storage (4) greater than the total required storage (3)?  
\_\_\_\_\_ yes \_\_\_\_\_ no
6. If "no", the sediment storage capacity of the pond must be increased. Choose the method to be used:  
\_\_\_\_\_ Raise the invert of the outlet structure \_\_\_\_\_ inches  
\_\_\_\_\_ Undercut the pond \_\_\_\_\_ feet  
\_\_\_\_\_ Other \_\_\_\_\_
7. Clean-out elevation = \_\_\_\_\_ ft  
(Elevation corresponding to 22 cy/ac \* \_\_\_\_\_ ac disturbed area)
8. Is the length-width ratio 2:1 or greater?  
\_\_\_\_\_ yes \_\_\_\_\_ no
9. If "no", the length of flow must be increased. Choose the method to be used:  
\_\_\_\_\_ Baffles (Type of baffle: \_\_\_\_\_ )  
\_\_\_\_\_ Other \_\_\_\_\_

**Note the CMP diameter and height** if a half-round CMP retrofit is to be used.

Diameter = \_\_\_\_\_ inches

Height = \_\_\_\_\_ feet

## ISOMETRICS

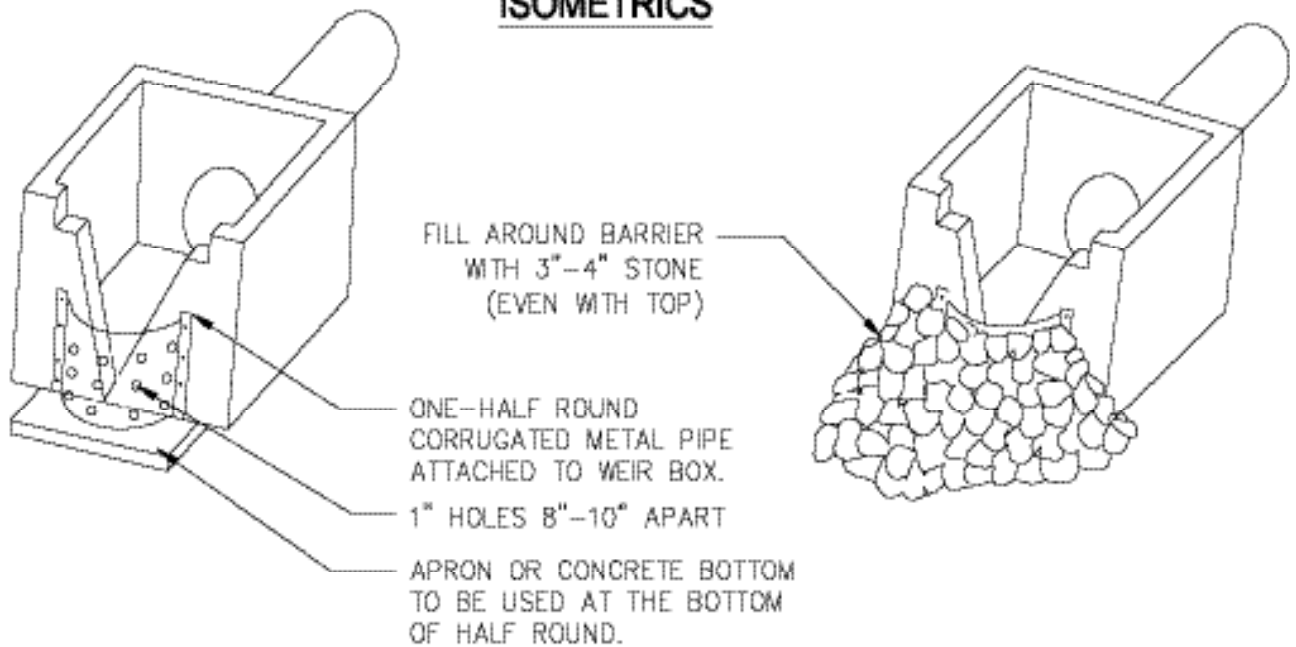

## PLAN

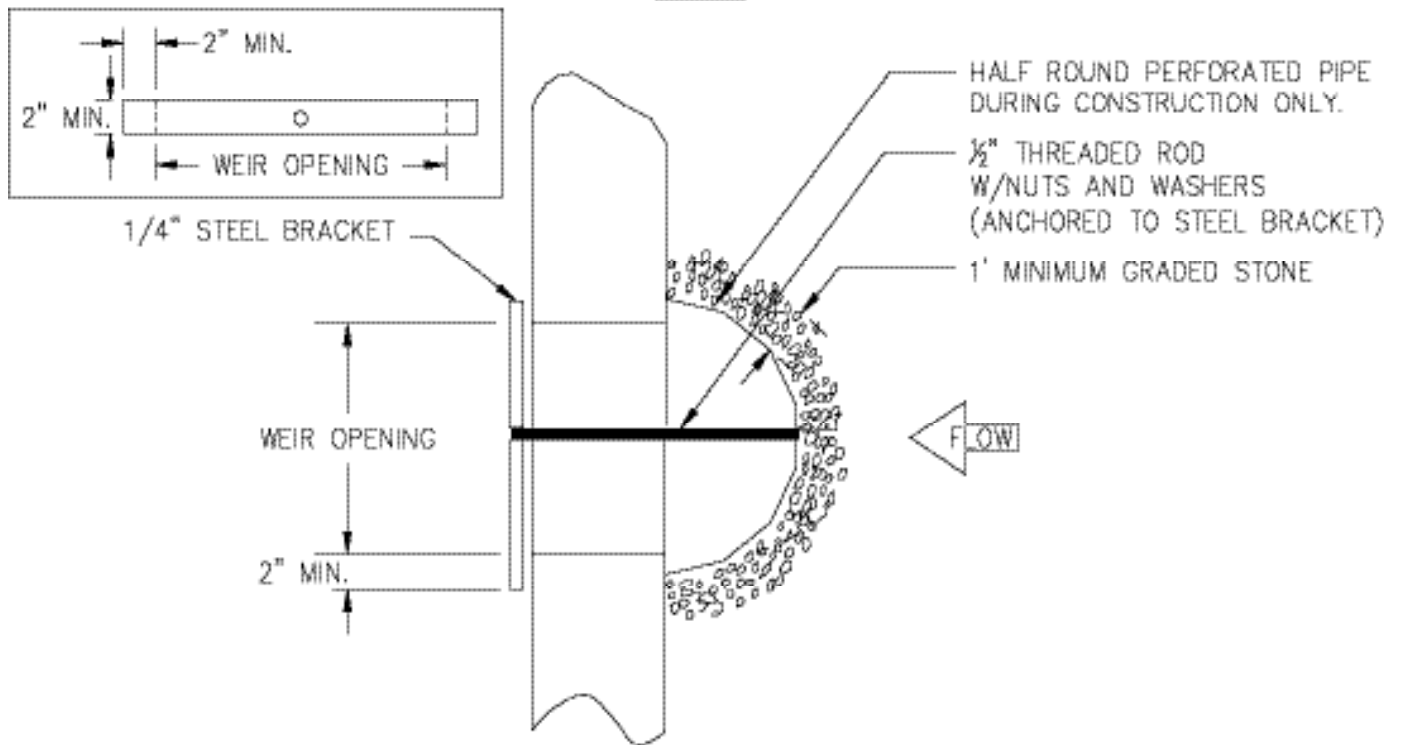

**Figure 6-26.1 Perforated Half- Round Pipe with Stone Filter**

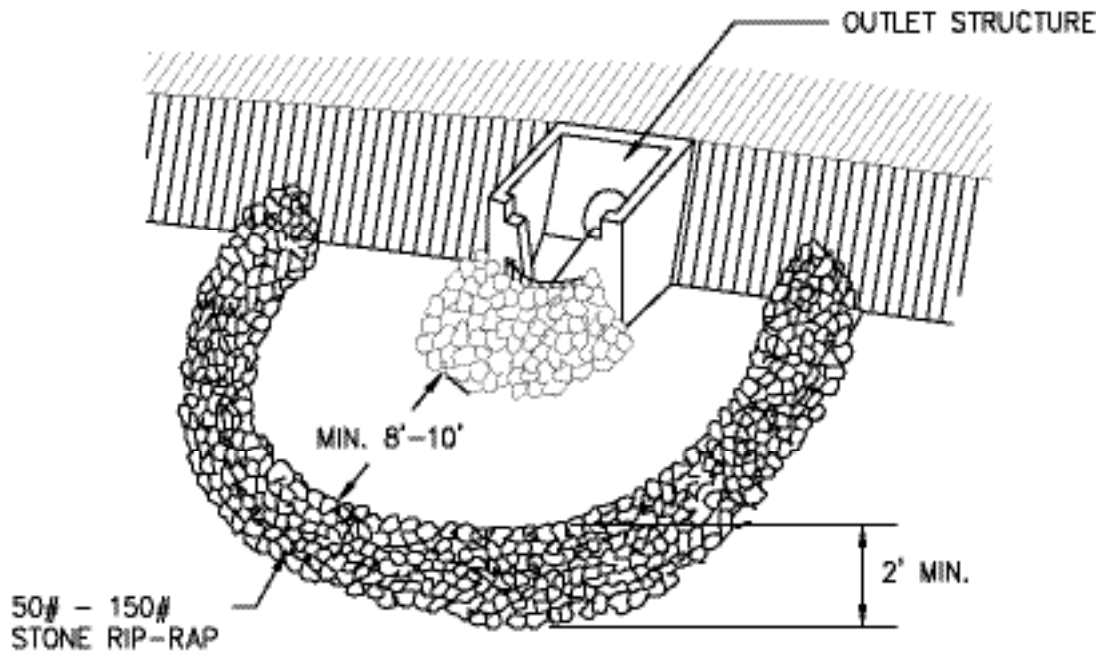
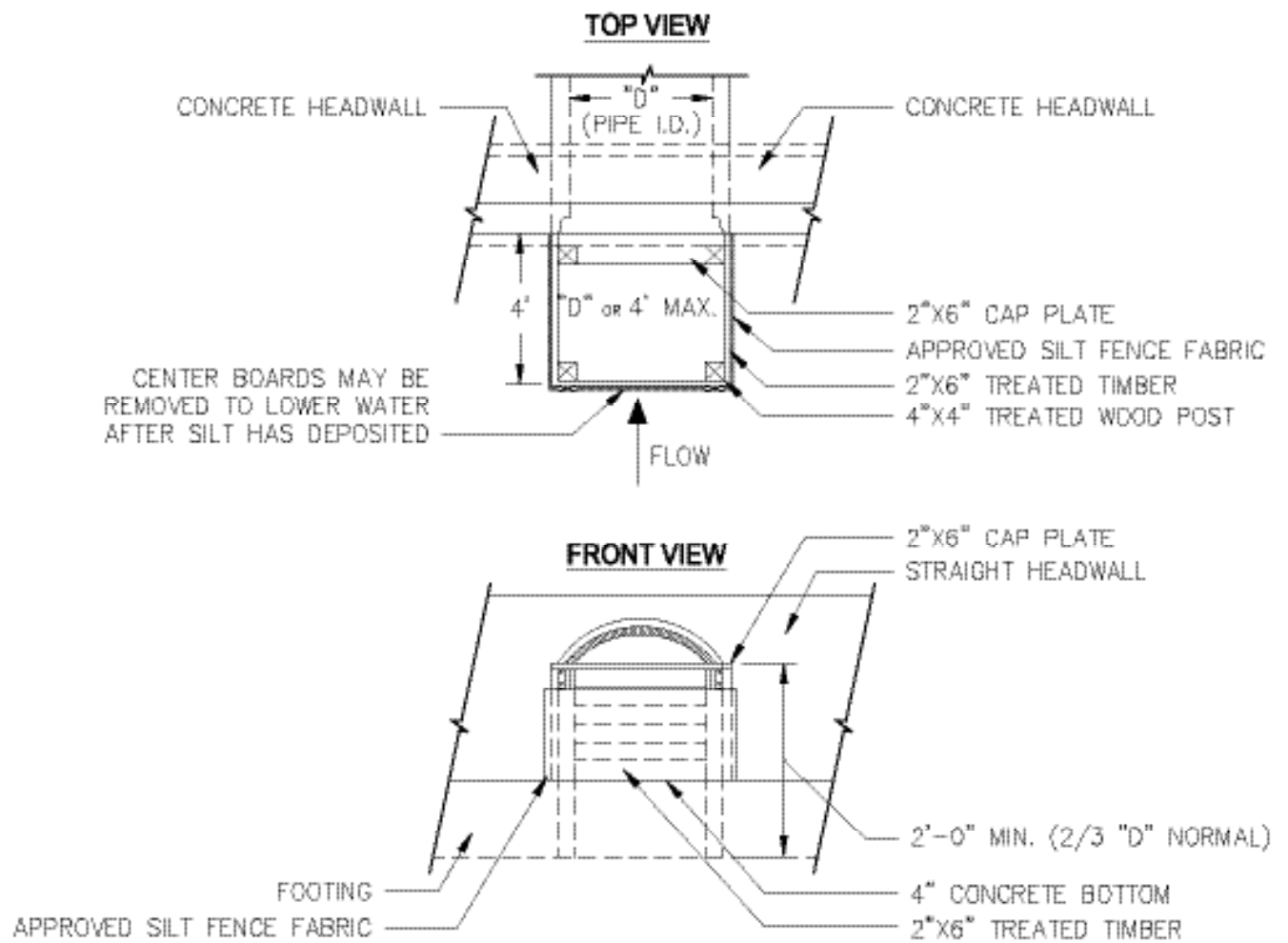

Figure 6-26.2 Stone Filter Ring



**Figure 6-26.3 Slotted Board Dam with Stone or Filter Fabric**

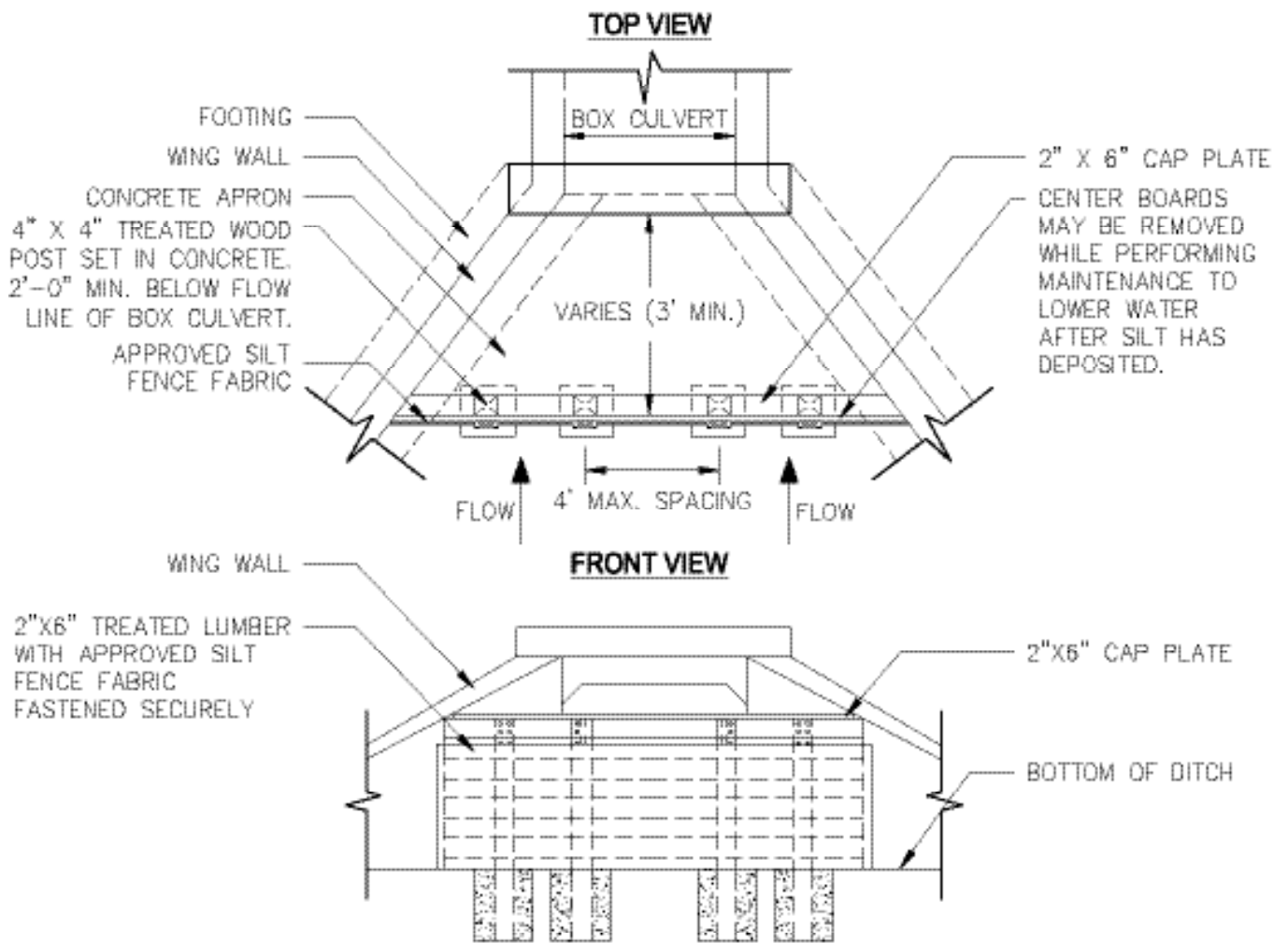
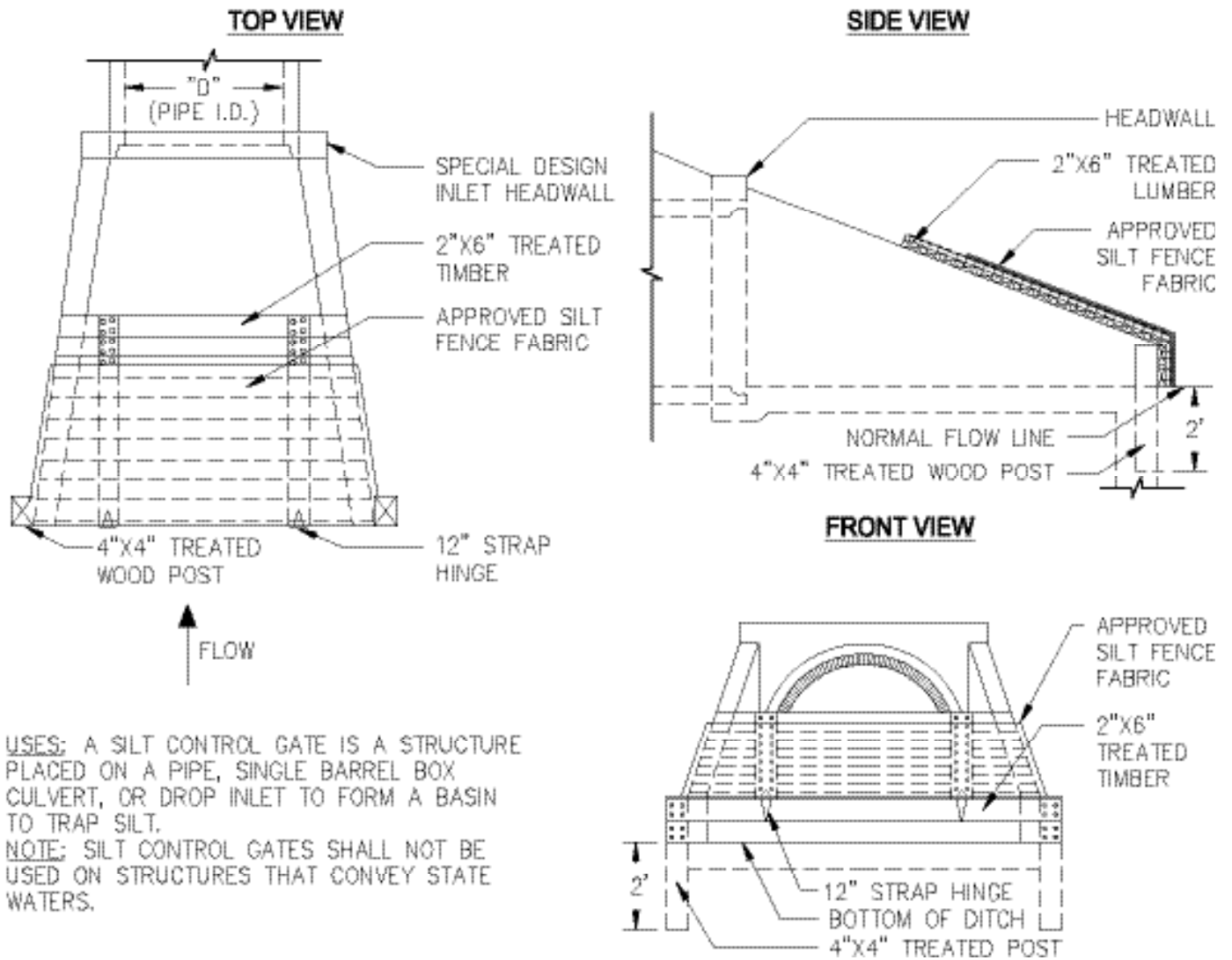

Figure 6-26.4 Silt Control Gate





**USES:** A SILT CONTROL GATE IS A STRUCTURE PLACED ON A PIPE, SINGLE BARREL BOX CULVERT, OR DROP INLET TO FORM A BASIN TO TRAP SILT.

**NOTE:** SILT CONTROL GATES SHALL NOT BE USED ON STRUCTURES THAT CONVEY STATE WATERS.

**Figure 6-26.5 Silt Control Gate**

# Sediment Barrier

Sd1



## DEFINITION

Sediment Barriers are temporary structures made up of a porous material typically supported by steel or wood posts. Types of sediment barriers may include silt fence, brush piles, mulch berms, compost filter socks or other filtering material.

## PURPOSE

To minimize and prevent sediment carried by sheet flow from leaving the site and entering natural drainage ways or storm drainage systems by slowing storm water runoff and causing the deposition and/or filtration of sediment at the structure. The barriers retain the soil on the disturbed land until the activities disturbing the land are completed and vegetation is established.

## CONDITIONS

Barriers should be installed where runoff can be stored behind the barrier without damaging the submerged area behind the barrier or the structure itself. Sediment barriers shall not be installed across streams, ditches, waterways, or other concentrated flow areas.

## DESIGN CRITERIA

Sediment barriers are designed to retain sediment transported by sheet flow from disturbed areas. It is important for the design professional to take into account the profile of the product for use on the site.

Sediment Barriers should also provide a riprap splash pad or other outlet protection device for any point where flow may overtop the sediment barrier. Ensure that the maximum height of the barrier at a protected, reinforced outlet does not exceed 1 foot and that the support spacing does not exceed 4 feet.

Where all runoff is to be stored behind the sediment barrier (where no storm water disposal system is present), maximum continuous slope length behind a sediment barrier shall not exceed those shown in Table 6-27.1. For longer slope lengths, slope interrupters must be used. The drainage area shall not exceed ¼ acre for every 100 feet of sediment barrier.

**Table 6-27.1 Criteria for Sediment Barrier**

Land Slope	Maximum Slope Length Above Fence
Percent	Feet
< 2	100
2 to 5	75
5 to 10	50
10 to 20	25
>20*	15

\*In areas where the slope is greater than 20%, a flat area length of 10 feet between the toe of slope to the barrier should be provided.

## Placement

The type of sediment barrier depends on whether the area is sensitive or nonsensitive. Sensitive areas can be defined as any area that needs additional protection, these areas include but are not limited to, state waters, wetlands, or any area the design professional designates as sensitive.

When using multiple types of sediment barriers on a site in a single run, the barriers must be overlapped 18 inches or as specified by design professional. See Figure 6-27.5

## CONSTRUCTION SPECIFICATIONS

**Non-sensitive Areas \* Sd1-NS**

Sediment barriers being used as Type NS shall have a support spacing of no greater than 6 feet on center, with each being driven into the ground a minimum of 18 inches.

## Sensitive Areas\*

**Sd1-S**

Sediment barriers being used as Type S shall have a support spacing of no greater than 4 feet on center, with each being driven into the ground a minimum of 18 inches.

\*As of January 1 2016, in the existing Georgia Department of Transportation Qualified Products list #36 (QPL- 36), Type A, B, or C will fall under sensitive and non-sensitive applications. **Type C will be classified as sensitive and Type A and B as non-sensitive.** Refer to Appendix A-2 and the Equivalent BMP List.

## PRACTICE CLASSIFICATIONS

**For silt fence Type A, B, or C, refer to Table 6-27.4.**

### Type A Silt Fence

This 36-inch wide filter fabric shall be used on developments where the life of the project is great than or equal to six months. **Type A is classified as non-sensitive application.**

### Type B Silt Fence

Though only 22-inches wide, this filter fabric allows the same flow rate as Type A silt fence. Type B silt fence shall be limited to use on minor projects, such as residential home sites or small commercial developments where permanent stabilization will be achieved in less than six months. **Type B is classified as non-sensitive application.**

### Type C Silt Fence

Type C fence is 36-inches wide with wire reinforcement. The wire reinforcement is necessary because this fabric allows almost three times the flow rate as Type A silt fence. Type C silt fence shall be used where runoff flows or velocities are particularly high or where slopes exceed a vertical height of 10 feet. **Type C is classified as sensitive application.**

## Filter Media Sock Specifications

Compost filter media used for sediment barrier filler material shall be weed free and derived from a well-decomposed source of organic matter. **Filter Media Sock is classified as a Type B, non-sensitive application.** The compost shall be produced using an aerobic composting

process meeting CFR 503 regulations including time and temperature data. The compost shall be free of any refuse, contaminants or other materials toxic to plant growth. Non-composted products will not be accepted. Test methods for the items below should follow US Composting Council Test Methods for the Examination of Composting and Compost guidelines for laboratory procedures:

A. pH – 5.0-8.0 in accordance with TMECC 04.11-A, “Electrometric pH Determinations for Compost”

B. Particle size – 99% passing a 2 inch (50mm) sieve and a maximum of 40% passing a 3/8 inch (9.5mm) sieve, in accordance with TMECC 02.02-B, “Sample Sieving for Aggregate Size Classification”. (Note: In the field, product commonly is between 1/2 in./12.5mm and 2 in./50 mm in particle size.)

C. Moisture content of less than 60% in accordance with standardized test methods for moisture determination.

D. Material shall be relatively free (<1% by dry weight) of inert or foreign manmade materials.

E. Sock containment system for compost filter media shall be a photodegradable or biodegradable knitted mesh material with 1/8 in. to 3/8 in., openings.

## Brush Barrier

**Sd1-BB**

**(Only during timber clearing operations)**

Brush obtained from clearing and grubbing operations may be piled in a row along the perimeter of disturbance at the time of clearing and grubbing. Brush barriers should not be used in developed areas or locations where aesthetics are a concern.

Brush should be wind-rowed on the contour as nearly as possible and may require compaction. Construction equipment may be utilized to satisfy this requirement.

The minimum base width of the brush barrier shall be 5 feet and should be no wider 10 feet. The height of the brush barrier should be between 3 and 5 feet tall.

A brush barrier is a good tool to use in de-veloping pasture in an agricultural situation to prevent sediment from leaving the site until the pasture is stabilized.

If greater filtering capacity is required, a commercially available sediment barrier may be placed on the side of the brush barrier receiving the sediment-laden runoff. The lower edge of the fabric must be buried in a 6-inch deep trench immediately uphill from the barrier. The upper edge must be stapled, tied or otherwise fastened to the brush barrier. Edges of adjacent fabric pieces must overlap each other. See Figure 6-27.5.

### Installation

Sediment barriers should be installed along the contour.

Temporary sediment barriers shall be installed according to the following specifications as shown on the plans or as directed by the design professional.

For installation of the barriers, See Figures 6-27.1, 6-27.2, 6-27.3 and 6-27.4, respectively. It is important to remember that not all sediment barriers need to be trenched into the ground but most taller sediment barriers do.

Post installation shall start at the center of a low point (if applicable) with the remaining posts spaced no greater than 6 feet apart for Type NS sediment barriers and no greater than 4 feet apart for Type C sediment barriers. For post size requirements, see Table 6-27.2. Fasteners for wood posts are listed in Table 6-27.3.

### Static Slicing Method

The static slicing machine pulls a narrow blade through the ground to create a slit 12" deep, and simultaneously inserts the silt fence fabric into this slit behind the blade. The blade is designed to slightly disrupt soil upward next to the slit and to minimize horizontal compaction, thereby creating an optimum condition for compacting the soil vertically on both sides of the fabric. Compaction is achieved by rolling a tractor wheel along both sides of the slit in the ground 2 to 4 times to achieve nearly the same or greater compaction as the original undisturbed

soil. This vertical compaction reduces the air spaces between soil particles, which minimizes infiltration. Without this compaction infiltration can saturate the soil, and water may find a pathway under the fence. When a silt fence is holding back several tons of accumulated water and sediment, it needs to be supported by posts that are driven 18 inches into the soil. Driving in the posts and attaching the fabric to them completes the installation.

### Trenching Method

Trenching machines have been used for over twenty-five years to dig a trench for burying part of the filter fabric underground. Usually the trench is about 2-"6" wide with a 6" excavation. Post setting and fabric installation often precede compaction, which make effective compaction more difficult to achieve. EPA supported an independent technology evaluation (ASCE 2001), which compared three progressively better variations of the trenching method with static slicing method. The static slicing method performed better than two lower performance levels of the trenching method, and was as good as or better than the trenching method's highest performance level. The best trenching method typically required nearly triple the time and effort to achieve results comparable to the static slicing method.

***Along all state waters and other sensitive areas, two rows of Type S sediment barriers shall be used. The two rows of Type S should be placed a minimum of 36 inches apart.***

### MAINTENANCE

**Sediment shall be removed once it has accumulated to one-half the original height of the barrier.**

Sediment barriers shall be replaced whenever they have deteriorated to such an extent that the effectiveness of the product is reduced (approximately six months) or the height of the product is not maintaining 80% of its properly installed height.

Temporary sediment barriers shall remain in place until disturbed areas have been permanently stabilized. All sediment accumulated at the barrier shall be removed and properly disposed of before the barrier is removed.

**TO BE SHOWN ON THE EROSION, SEDIMENTATION, AND POLLUTION CONTROL PLAN**  
**When a SEDIMENT BARRIER is used, show the product height in inches for each barrier being used on site.**

**REFERENCES:**

ASCE 2001. Environmental Technology Verification Report for Installation of Silt Fence Using the Tommy Static Slicing Method, CERF Report #40565. Washington, DC: American Society of Civil Engineers. [www.epa.gov/etv/pubs/08\\_vs\\_tommy.pdf](http://www.epa.gov/etv/pubs/08_vs_tommy.pdf)

ASTM 2003. Standard Practice for Silt Fence Installation, D 6462-03(2008). West Conshohocken, PA: American Society of Testing Materials International. [www.astm.org/SEARCH/search-reskin.html?query=D6462-03&siteType=store-standards&searchType=standards-full](http://www.astm.org/SEARCH/search-reskin.html?query=D6462-03&siteType=store-standards&searchType=standards-full)

Carpenter, Thomas 2000. Silt Fence That Works. Ankey, Iowa: Thomas Carpenter. [www.tommy-sfm.com/pages/resources/Silt%20Fence%20That%20Works%20Manual.pdf](http://www.tommy-sfm.com/pages/resources/Silt%20Fence%20That%20Works%20Manual.pdf)

Fifield, Jerald S. 2011. Designing and Reviewing Effective Sediment and Erosion Control Plans, 3rd Edition. Santa Barbara, CA: Forester Press.

U.S. Environmental Protection Agency 2007. Developing Your Stormwater Pollution Prevention Plan, EPA 833-R-06-004. Washington: EPA. Available from EPA hardcopy 800-490-9198 or [www.epa.gov/npdes/pubs/sw\\_swppp\\_guide.pdf](http://www.epa.gov/npdes/pubs/sw_swppp_guide.pdf)

# SILT FENCE - TYPE A and B

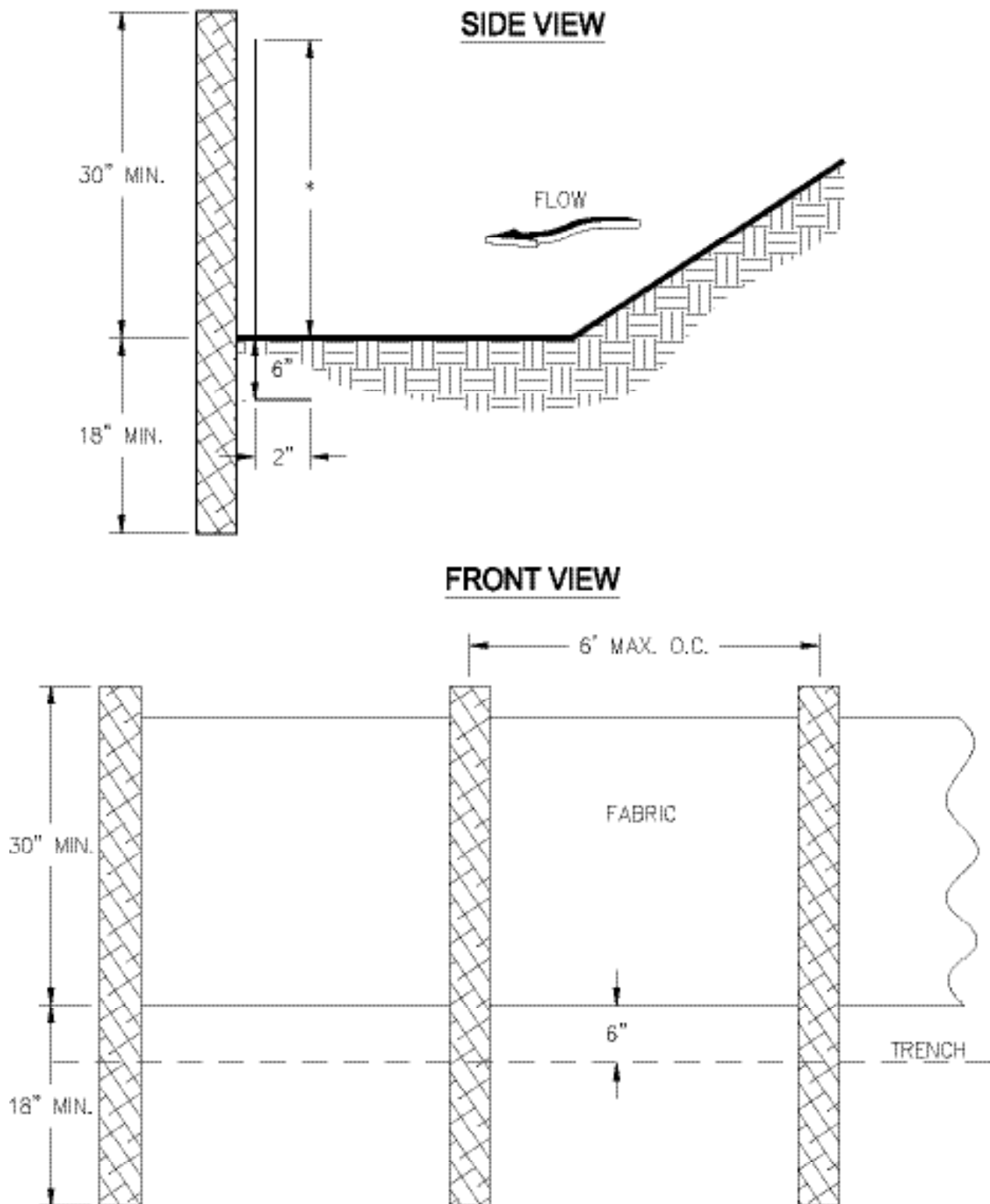

**NOTES:**

1. USE STEEL OR WOOD POSTS OR AS SPECIFIED BY THE EROSION, SEDIMENTATION, AND POLLUTION CONTROL PLAN.
2. HEIGHT (\*) IS TO BE SHOWN ON THE EROSION, SEDIMENTATION, AND POLLUTION CONTROL PLAN.

**Figure 6-27.1**

# SILT FENCE - TYPE C

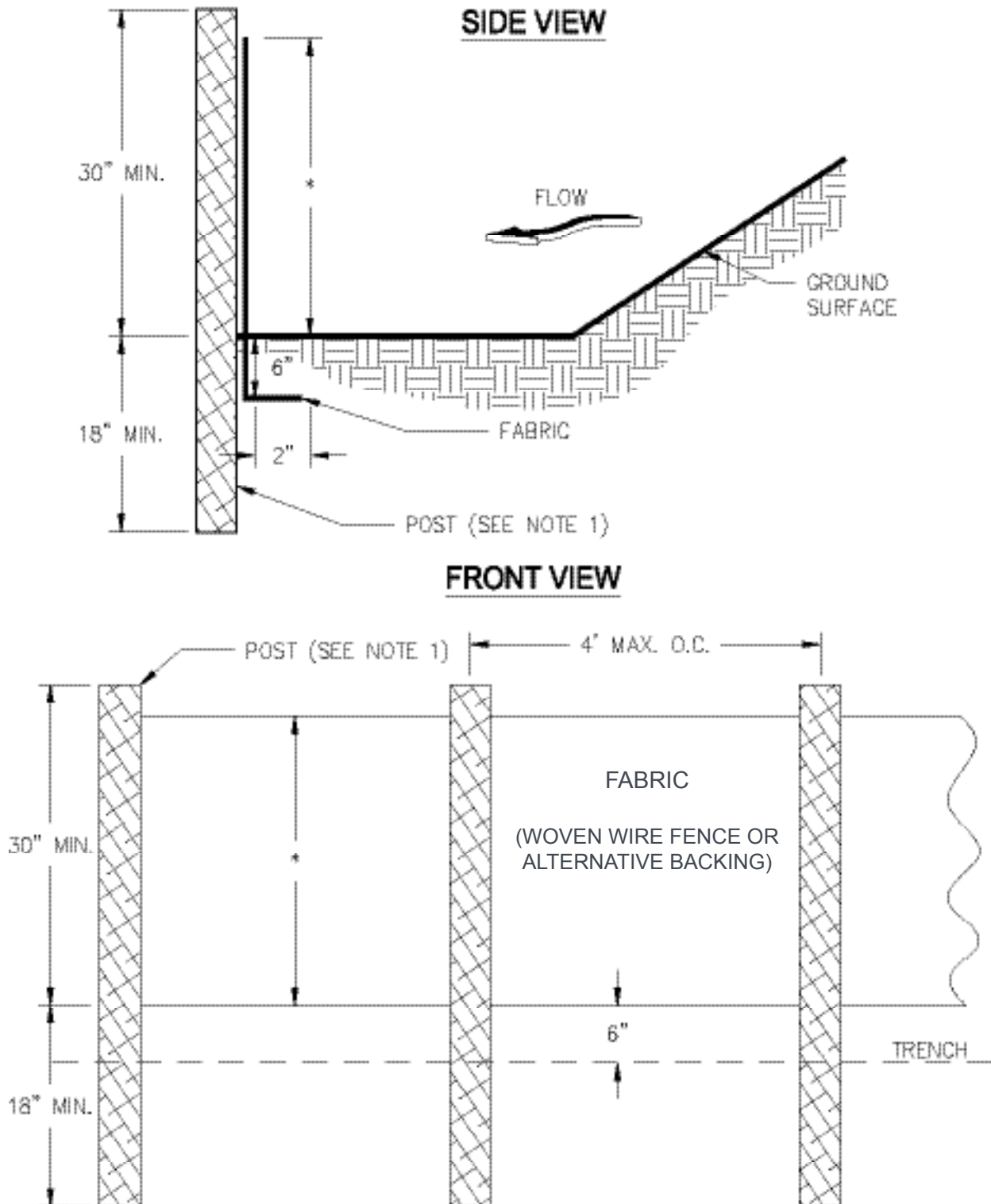

**NOTES:**

1. USE STEEL OR WOOD POSTS OR AS SPECIFIED BY THE EROSION, SEDIMENTATION, AND POLLUTION CONTROL PLAN.
2. HEIGHT (\*) IS TO BE SHOWN ON THE EROSION, SEDIMENTATION, AND POLLUTION CONTROL PLAN.

Figure 6-27.2

# EROSION AND SEDIMENT CONTROL

## TYPE B COMPOST FILTER SOCK

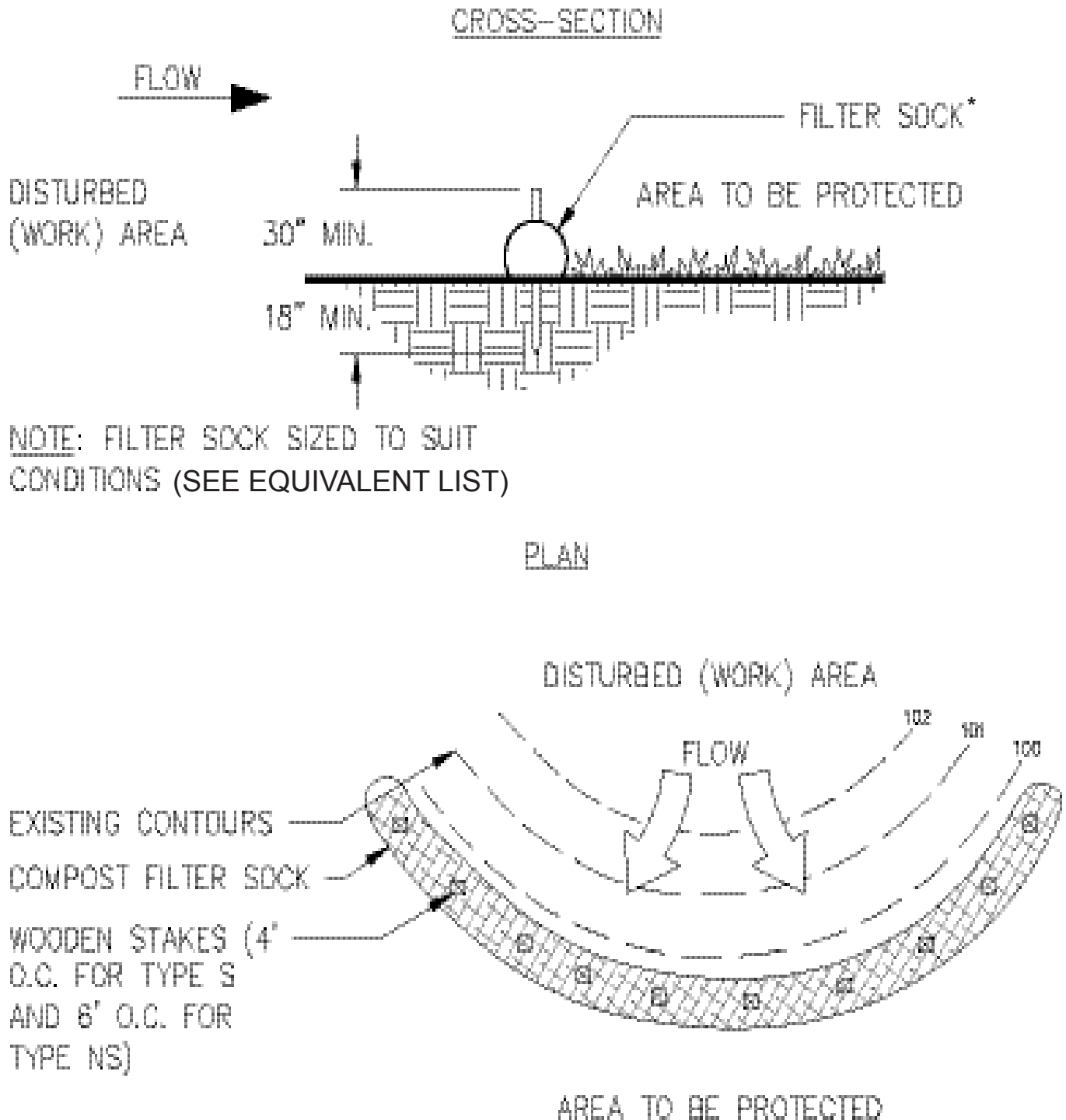

\*HEIGHT IS TO BE SHOWN ON THE EROSION, SEDIMENTATION AND POLLUTION CONTROL PLAN

Figure 6-27.3



# SEDIMENT BARRIERS

## BRUSH BARRIER SECTION

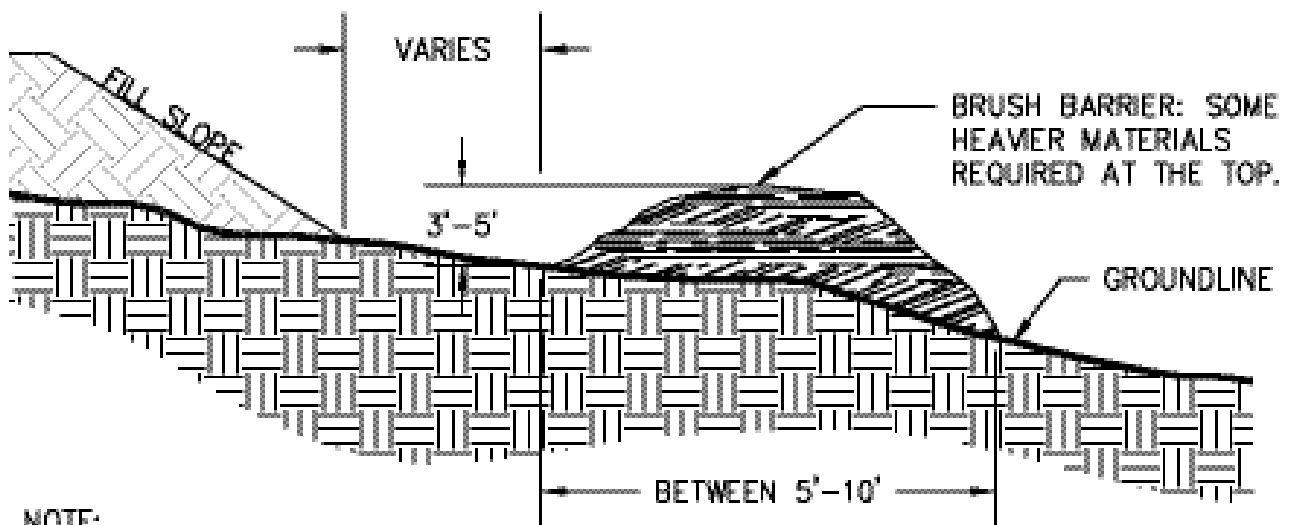

### NOTE:

1. INTERMINGLE BRUSH, LOGS, ETC. SO AS TO NOT FORM A SOLID DAM.
2. BRUSH SHOULD BE WIND-ROWED ON THE CONTOUR AS CLOSE AS POSSIBLE.
3. MINIMUM BASE WIDTH FOR BARRIER SHALL BE 5 FEET AND SHOULD BE NO WIDER THAN 10 FEET. THE HEIGHT OF THE BARRIER SHOULD BE BETWEEN 3' AND 5'.
4. A COMMERCIALY AVAILABLE FILTER FABRIC MAY BE PLACED ON THE SIDE OF THE BRUSH BARRIER RECEIVING SEDIMENT-LADEN RUNOFF FOR ADDED FILTER CAPACITY (LOWER EDGE MUST BE BURIED IN A 6 INCH DEEP TRENCH AND THE UPPER EDGE MUST BE FASTENED TO THE BRUSH BARRIER).

Figure 6-27.4

Type	Min Length	Type of Post	Size of Post
NS	4'	Soft wood Oak Steel	3" dia or 2x4 1.5" x 1.5" 1.15lb./ft. min
S	4'	Steel Oak	1.3lb./ft. min 2"x2"

	Gauge	Crown	Legs	Staples / Post
Wire Staples	17 min.	3/4" wide	1/2" long	5 min.
	Gauge	Length	Button Heads	Nail/ Post
Nails	14 min.	1"	3/4"	4 min.

Note: Filter Fabric may also be attached to the post by wire, cords, and pockets.

## FASTENERS FOR SILT FENCES

### OVERLAP AT FABRIC ENDS

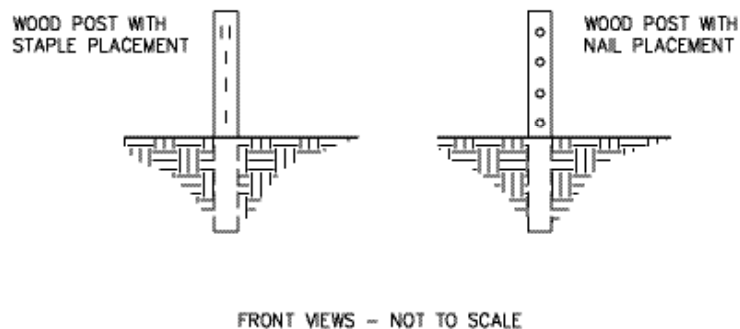
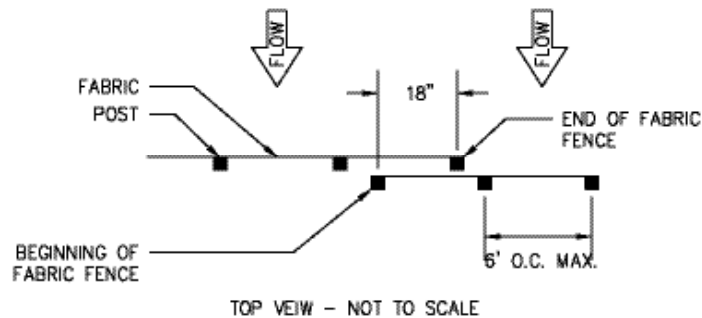

#### NOTES:

1. THE FABRIC AND WIRE SHOULD BE SECURELY FASTENED TO POSTS AND FABRIC ENDS MUST BE OVERLAPPED A MINIMUM OF 18" OR WRAPPED TOGETHER AROUND A POST TO PROVIDE A CONTINUOUS FABRIC BARRIER.

**Figure 6-27.5**

**Table 6-27.4**

<b>TYPE FENCE</b>	<b>A</b>	<b>B</b>	<b>C</b>
Tensile Strength (Lbs. Min.) (1) (ASTM D-4632)	Warp - 120 Fill - 100	Warp - 120 Fill - 100	Warp - 260 Fill - 180
Elongation (% Max.) (ASTM D-4632)	40	40	40
AOS (Apparent Opening Size) (Max. Sieve Size) (ASTM D-4751)	#30	#30	#30
Flow Rate (Gal/Min/Sq. Ft.) (GDT-87)	25	25	70
Ultraviolet Stability (2) (ASTM D-4632 after 300 hours weathering in accordance with ASTM D-4355)	80	80	80
Bursting Strength (PSI Min.) (ASTM D-3786 Diaphragm Bursting Strength Tester)	175	175	175
Minimum Fabric Width (Inches)	36	22	36

(1) Minimum roll average of five specimens.

(2) Percent of required initial minimum tensile strength.

# Inlet Sediment Trap **Sd2**



## DEFINITION

A temporary protective device formed at or around an inlet to a storm drain to trap sediment.

## PURPOSE

To prevent sediment from entering a storm drainage systems prior to permanent stabilization of the disturbed area draining to the inlet.

## CONDITIONS

All storm drain drop inlets that receive runoff from disturbed areas.

## DESIGN CRITERIA

Through testing there are two different categories (high retention and high flow) supported. In areas where BMPs are being used on paved surfaces, or safety is a concern, the potentially negative effects of ponding should be taken into account. In such cases, a high flow BMP is preferred.

On unpaved areas where ponding will not cause a safety hazard, high retention shall be taken into account. If high retention is not used in this situation a rationale shall be given on the plan and an unpaved application should apply.

Sediment traps must be self-draining unless they are otherwise protected in an approved fashion that will not present a safety hazard. The drainage area entering the inlet sediment trap shall be no greater than one acre.

If runoff may bypass the protected inlet, a temporary dike should be constructed on the down slope side of the structure. Also, a stone

filter ring may be used on the up slope side of the inlet to slow runoff and filter larger soil particles. Refer to **Fr-Stone Filter Ring**.

## CONSTRUCTION SPECIFICATIONS Excavated Inlet Sediment Trap

An excavation may be created around the inlet sediment trap to provide additional sediment storage. The trap shall be sized to provide a minimum storage capacity calculated at the rate of 67 cubic yards per acre of drainage area. A minimum depth of 1.5 feet for sediment storage should be provided. Side slopes shall not be steeper than 2:1.

Sediment traps may be constructed on natural ground surface, on an excavated surface, or on machine compacted fill, provided they have a non-erodible outlet.

## Filter Fabric with Supporting Frame

**Sd2 -F**

This method of inlet protection is applicable where the inlet drains a relatively flat area (slope no greater than 5%) and shall not apply to inlets receiving concentrated flows, such as in street or highway medians. As shown in Figure 6-28.1, Type S silt fence supported by steel posts should be used. The stakes shall be spaced evenly around the perimeter of the inlet a maximum of 3 feet apart, and securely driven into the ground, approximately 18 inches deep. The fabric shall be 36 inches tall and entrenched 12 inches and backfilled with crushed stone or compacted soil. Fabric and wire shall be securely fastened to the posts, and fabric ends must be overlapped a minimum of 18 inches or wrapped together around a post to provide a continuous fabric barrier around the inlet.

## Baffle Box

**Sd2 -B**

For inlets receiving runoff with a higher volume or velocity, a baffle box inlet sediment trap should be used. As shown in Figure 6-28.2, the baffle box shall be constructed of 2" x 4" boards spaced a maximum of 1 inch apart or of plywood with weep holes 2 inches in diameter. The weep holes shall be placed approximately 6 inches on center vertically and horizontally. Gravel shall be placed outside the box, all around the inlet, to a depth of 2 to 4 inches. The entire box is wrapped

in Type C filter fabric that shall be entrenched 12 inches and backfilled.

### **Block and Gravel Drop Inlet Protection**

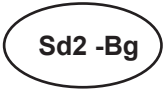

This method of inlet protection is applicable where heavy flows are expected and where an overflow capacity is necessary to prevent excessive ponding around the structure. As shown in Figure 6-28.3, one block is placed on each side of the structure on its side in the bottom row to allow pool drainage. The foundation should be excavated at least 2 inches below the crest of the storm drain. The bottom row of blocks is placed against the edge of the storm drain for lateral support and to avoid washouts when overflow occurs. If needed, lateral support may be given to subsequent rows by placing 2" x 4" wood studs through block openings. Hardware cloth or comparable wire mesh with 1/2 inch openings shall be fitted over all block openings to hold gravel in place. Clean gravel should be placed 2 inches below the top of the block on a 2:1 slope or flatter and smoothed to an even grade. DOT #57 washed stone is recommended.

### **Gravel drop Inlet Protection**



This method of inlet protection is applicable where heavy concentrated flows are expected. As shown in Figure 6-28.4, stone and gravel are used to trap sediment. The slope toward the inlet shall be no steeper than 3:1. A minimum 1 foot wide level stone area shall be left between the structure and around the inlet to prevent gravel from entering the inlet. On the slope toward the inlet, stone 3 inches in diameter and larger should be used. On the slope away from the inlet, 1/2 to 3/4 inch gravel (#57 washed stone) should be used at a minimum thickness of 1 foot.

### **Sod Inlet Protection**

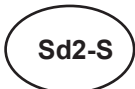

This method of inlet protection is applicable only at the time of permanent seeding, to protect the inlet from sediment and mulch material until permanent vegetation has become established. As shown in Figure 6-28.5, the sod shall be placed to form a turf mat covering the soil for

a distance of 4 feet from each side of the inlet structure. Sod strips shall be staggered so that adjacent strip ends are not aligned.

### **Curb Inlet Protection**

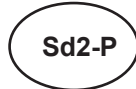

Once pavement has been installed, a curb inlet filter shall be installed on inlets receiving runoff from disturbed areas. This method of inlet protection shall be removed if a safety hazard is created.

One method of curb inlet protection uses "pigs-in-a-blanket"- 8-inch concrete blocks wrapped in filter fabric. See Figure 6-28.6. Another method uses gravel bags constructed by wrapping DOT #57 stone with filter fabric, wire, plastic mesh, or equivalent material.

A gap of approximately 4 inches shall be left between the inlet filter and the inlet to allow for overflow and prevent hazardous ponding in the roadway. Proper installation and maintenance are crucial due to possible ponding in the roadway, resulting in a hazardous condition. Several other methods are available to prevent the entry of sediment into storm drain inlets.

Figure 6-28.7 shows one of these alternative methods.

### **MAINTENANCE**

The trap shall be inspected daily and after each rain, and repairs made as needed. Sediment shall be removed when the sediment has accumulated to one-half the height of the trap. Sediment shall be removed from curb inlet protection immediately. For excavated inlet sediment traps, sediment shall be removed when one-half of the sediment storage capacity has been lost to sediment accumulation. Sod inlet protection shall be maintained as specified in **Ds4 - Disturbed Area Stabilization (With Sodding)**.

Sediment shall not be washed into the inlet. It shall be removed from the sediment trap, disposed of and stabilized so that it will not enter the inlet again.

When the contributing drainage area has been permanently stabilized, all materials and any sediment shall be removed, and either

salvaged or disposed of properly. The disturbed area shall be brought to proper grade, then smoothed and compacted. Appropriately stabilize all disturbed areas around the inlet.

# FABRIC AND SUPPORTING FRAME FOR INLET PROTECTION

## STEEL FRAME AND SILT FENCE INSTALLATION

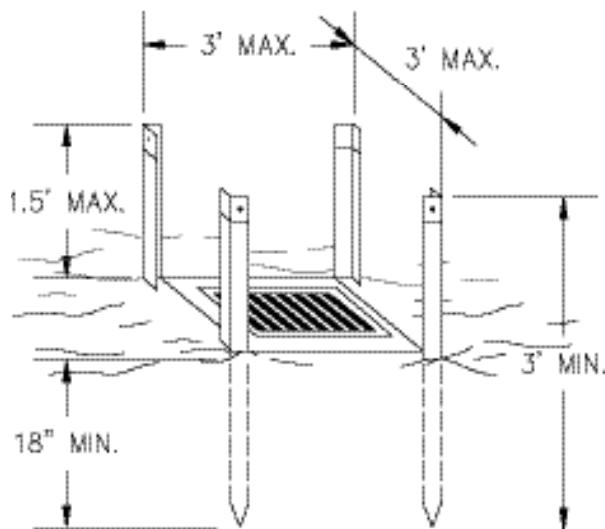

### NOTES:

1. DESIGN IS FOR SLOPES NO GREATER THAN 5% (NOT DESIGNED FOR CONCENTRATED FLOWS).
2. THE STEEL POSTS SUPPORTING THE SILT FENCE MATERIAL SHOULD BE SPACED EVENLY AROUND THE PERIMETER OF THE INLET (MAXIMUM OF 3' APART).
3. THE STEEL POSTS SHOULD BE SECURELY DRIVEN AT LEAST 18" DEEP.
4. THE FABRIC SHOULD BE ENTRENCHED AT LEAST 12" AND THEN BACKFILLED WITH CRUSHED STONE OR COMPACTED SOIL.

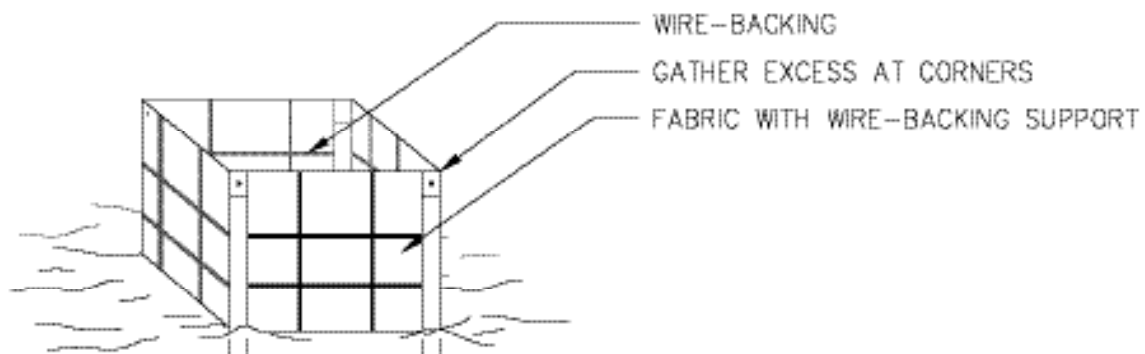
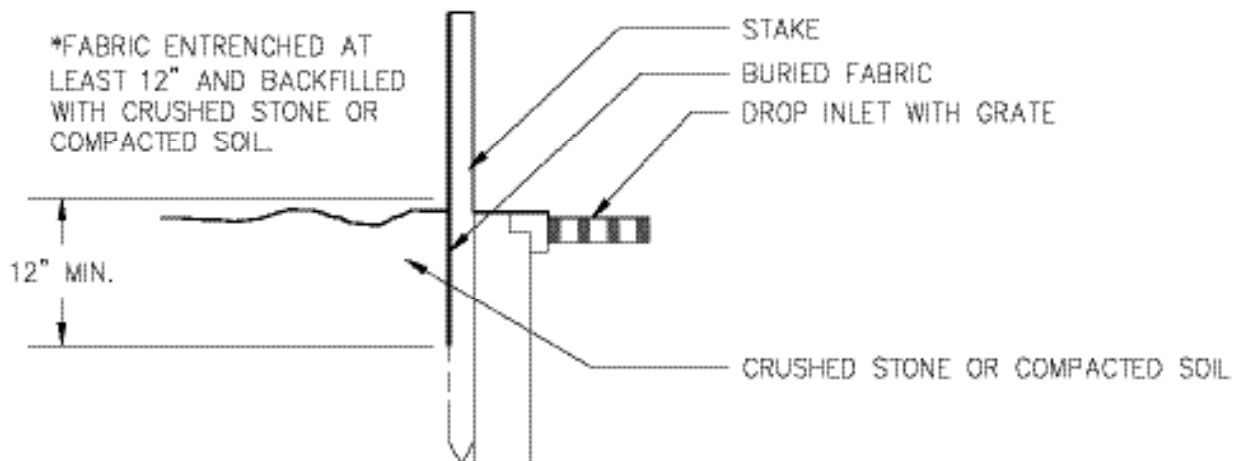

Figure 6-28.1 - Fabric and Supporting Frame For Inlet Projection

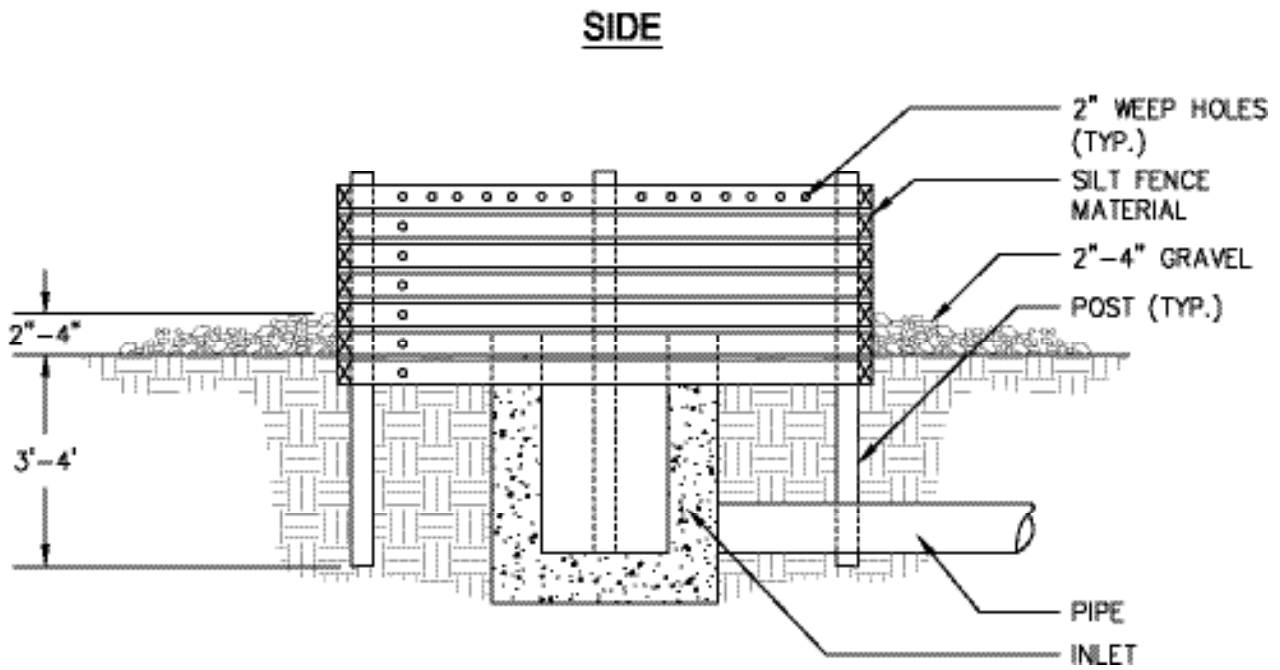
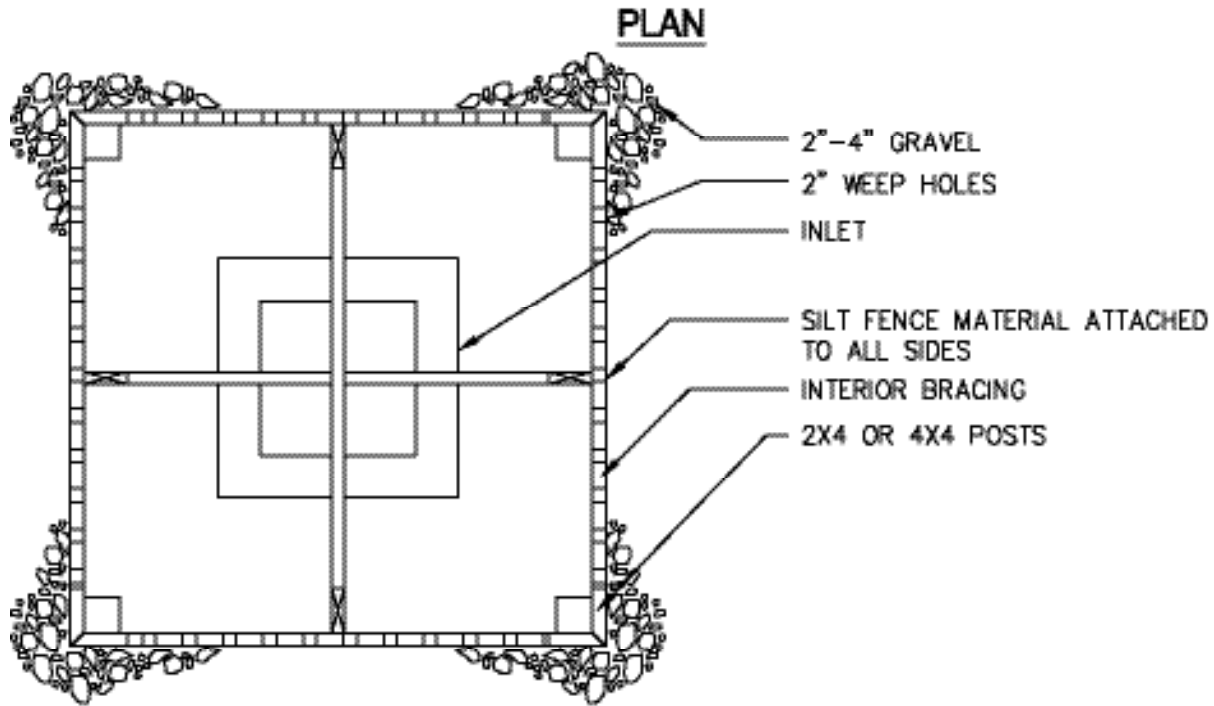
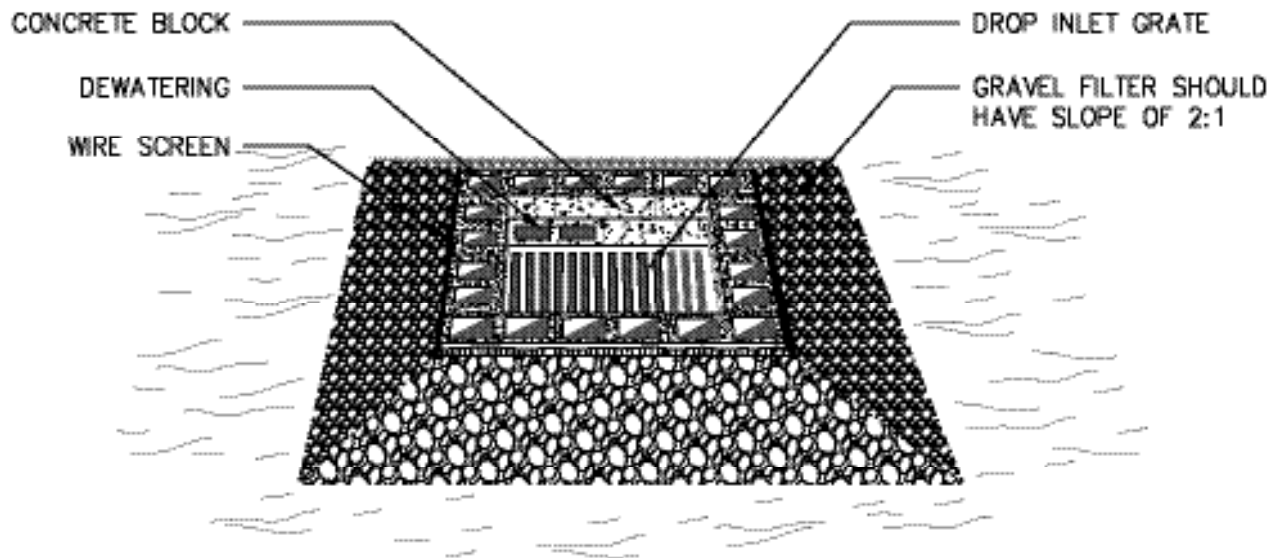

Figure 6-28.2 Baffle Box



## BLOCK AND GRAVEL PERSPECTIVE



## BLOCK AND GRAVEL SECTION

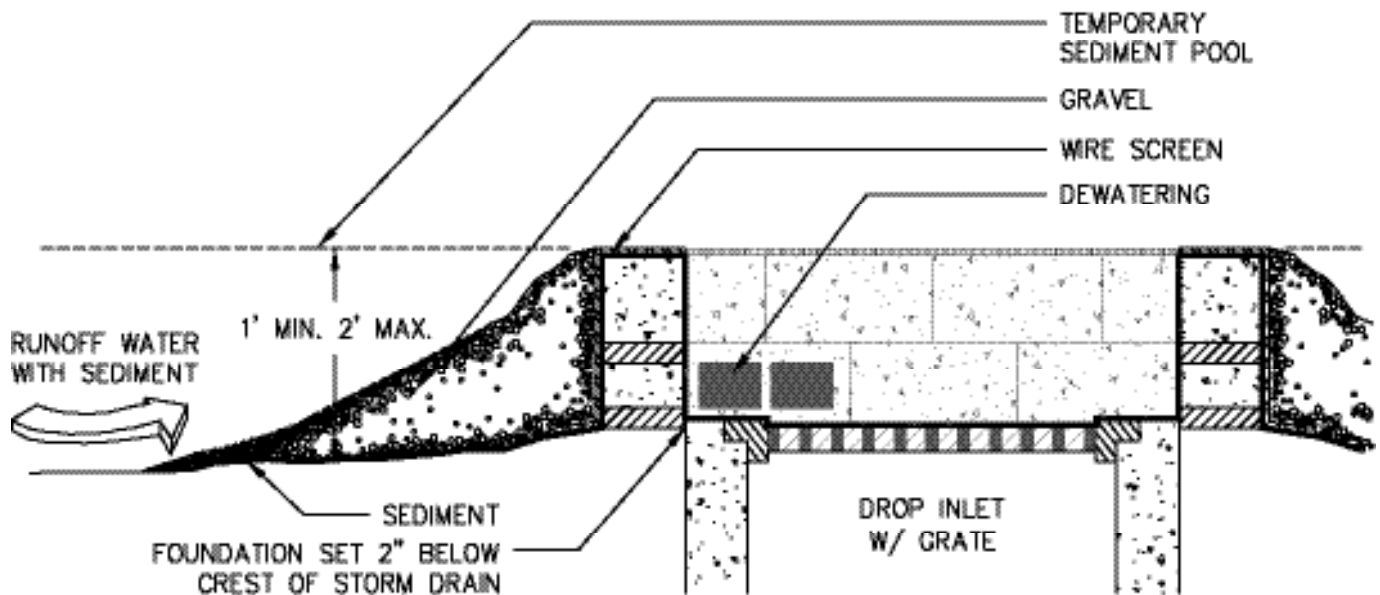

**NOTE:**

1. HARDWARE CLOTH OR COMPARABLE WIRE MESH WITH  $\frac{1}{2}$  INCH OPENINGS SHALL BE FITTED OVER ALL BLOCK OPENINGS TO HOLD GRAVEL IN PLACE.
2. THE FOUNDATION SHOULD BE EXCAVATED AT LEAST 2 INCHES BELOW THE CREST OF THE STORM DRAIN. THE FIRST ROW OF BLOCKS WILL BE PLACED HERE FOR LATERAL SUPPORT.
3. ONE BLOCK (AS SHOWN) IS TO BE PLACED ON EACH SIDE OF THE STRUCTURE ON ITS SIDE IN THE BOTTOM ROW TO ALLOW FOR POOL DRAINAGE.

Figure 6-28.3 Block and Gravel Drop Inlet Protections

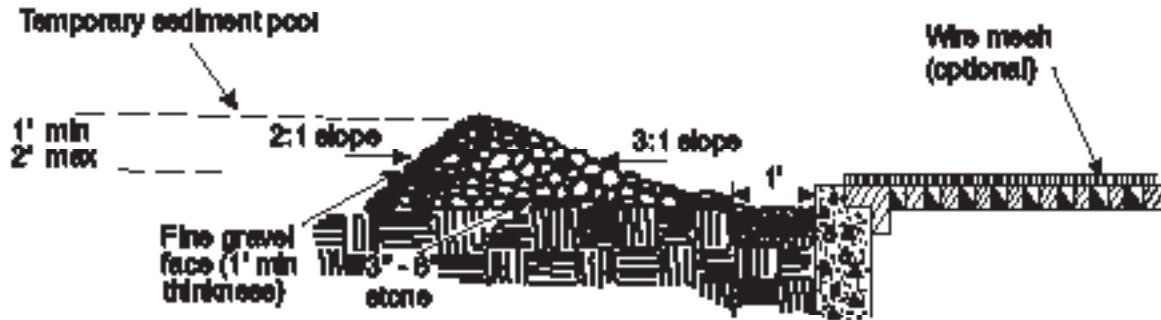

Figure 6-28.4 Gravel Drop Inlet Protection

SOD STRIPS PROTECT INLET AREA FROM EROSION  
(SOURCE: VA SWCC)

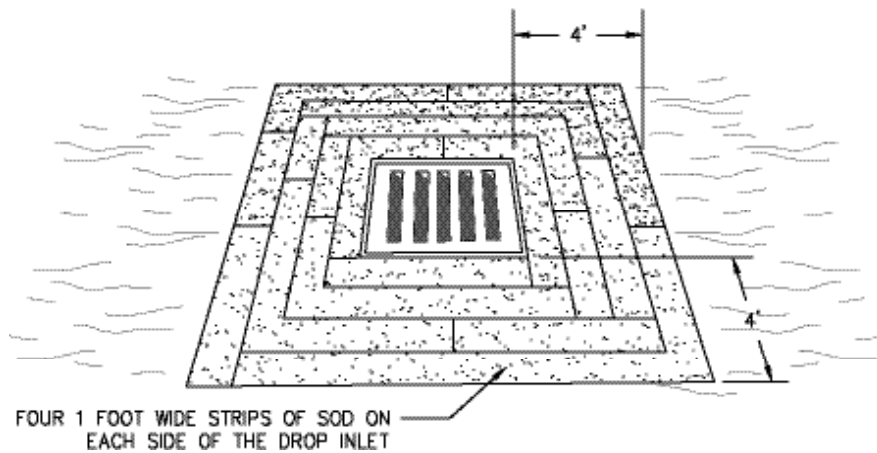

Figure 6-28.5 Sod Inlet Protection

# CURB INLET FILTER "PIGS IN BLANKET"

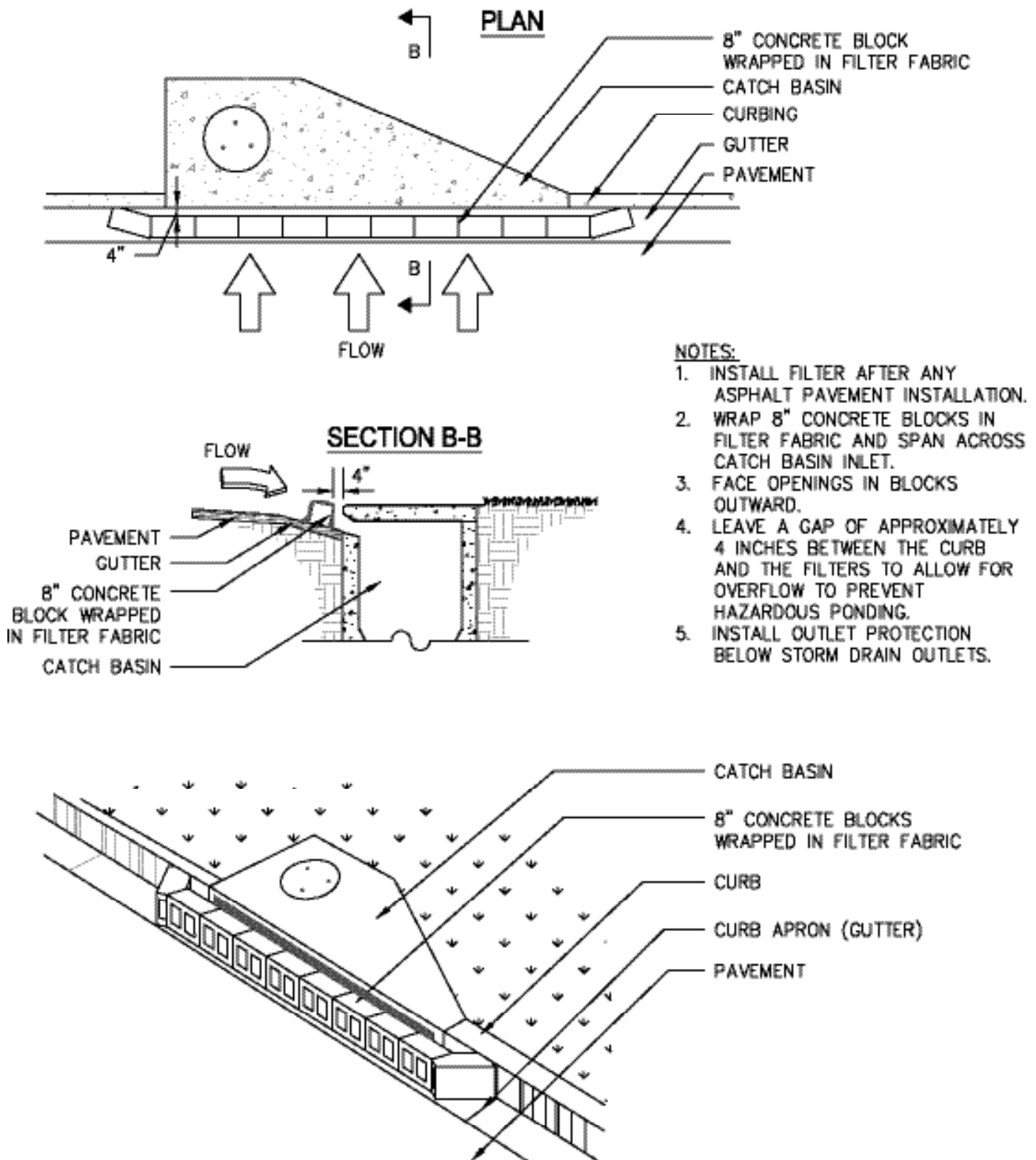

Figure 6-28.6 Curb Inlet Filter "Pigs in Blanket"

## TO BE SHOWN ON THE EROSION AND SEDIMENT CONTROL PLAN

If the **EXCAVATED INLET SEDIMENT TRAP** is used, show the following information:

1. **Drainage area** = \_\_\_\_\_ ac
2. Required sediment storage = 67 cy/ac \* drainage area  
Required sediment storage = 67 cy/ac \* \_\_\_\_\_ ac  
**Required sediment storage** = \_\_\_\_\_ cy = \_\_\_\_\_ cf
3. Assume excavation **depth** (minimum of 1.5 ft.) = \_\_\_\_\_ ft
4. Assume **slope of sides** (shall not be steeper than 2:1) = \_\_\_ :1
5. Determine required surface area  
 $SA_{min} = \text{Required sediment storage} / \text{excavation depth}$   
 $SA_{min} = \text{_____ cy} / \text{_____ ft}$   
**SA<sub>min</sub>** = \_\_\_\_\_ sf
6. Assume shape of excavation and determine dimensions.  
(A rectangular shape with 2:1 length to width ratio is recommended.)  
**Shape:** \_\_\_\_\_  
**Dimensions:** l = \_\_\_\_\_ ft    w = \_\_\_\_\_ ft    diameter (*if applicable*) = \_\_\_\_\_ ft

Provide a detail showing the depth, length and width, or diameter (*if applicable*), and side slopes of the excavation.



**Figure 6-28.7 Equivalent Inlet Sediment Trap**



# Temporary Sediment Basin

Sd3



## DEFINITION

A basin created by the construction of a barrier or dam across a concentrated flow area, or by excavating a basin, or by a combination of both. A sediment basin typically consists of a dam, a pipe outlet, and an emergency spillway. The size of the structure will depend upon the location, size of the drainage area, soil type, and rainfall pattern.

## PURPOSE

To detain runoff waters and trap sediment from erodible areas in order to protect properties and drainage ways below the installation from damage by excessive sedimentation and debris. The water is temporarily stored and the bulk of the sediment carried by the water drops out and is retained in the basin while the water is automatically released.

## CONDITIONS

This practice applies to critical areas where physical site conditions, construction schedules, or other restrictions preclude the installation or establishment of erosion control practices to satisfactorily reduce runoff, erosion, and sedimentation. The structure may be used in combination with other practices and should remain in effect until the sediment-producing area is permanently stabilized.

This standard applies to the installation of temporary (to be removed within 18 months) sediment basins on sites where: (1) failure of the structure would not result in loss of life or interruption of use or service of public utilities, and (2) the drainage area does not exceed 150 acres.

## DESIGN CRITERIA

### Compliance With Laws and Regulations

Design and construction shall comply with state and local laws, ordinances, rules and regulations. Basins shall be constructed according to the approved erosion and sediment control plan unless modified by the design professional.

### Location

**Sediment basins shall never be placed in live streams.** They should be located so that storm drains discharge into the basin. The sediment basin should be located to obtain the maximum storage benefit from the terrain and for ease of clean-out of the trapped sediment. It should be located to minimize interference with construction activities and construction of utilities.

### Volume

The sediment storage volume of the basin, as measured to the elevation of the crest of the principal spillway, shall be at least 67 cubic yards per acre for the disturbed area draining into the basin (67 cubic yards is equivalent to 1/2 inch of sediment per acre of drainage area). *The entire drainage basin area should be used for this computation*, rather than the disturbed area alone, to help ensure adequate trapping efficiency. *Sediment shall be removed from the basin when approximately one-third of the storage volume has been lost to sediment accumulation.* This volume shall be marked on the riser or by setting a marked post near the riser.

### Surface Area

Studies (Barfield and Clar, 1985) indicate that the following relationship between surface area and peak inflow rate gives a trapping efficiency from greater than 75% for clay loam to 95% for loamy sandy soils.

$$A = 0.01q$$

Where A is basin surface area in acres and q is peak inflow rate in cfs. Area is measured at the crest of the principal spillway riser. The minimum peak inflow rate is determined from a 2-year, 24-hour storm.

### Shape

It is recommended that the designer of a sediment basin incorporate features to maximize detention time within the basin. Suggested methods

of accomplishing this objective are:

1. Length to width ratio greater than 2:1, where length is the distance between the inlet and outlet.
2. A wedge shape with the inlet located at the narrow end.
3. Installation of baffles or diversions.

#### *Procedure for Determining or Altering Sediment Basin Shape*

As specified in the Standards and Specification, the pool area at the elevation of crest of the principal spillway shall have a length to width ratio of at least 2:1. The purpose of this requirement is to minimize the “short-circuiting” effect of the sediment-laden inflow to the riser and thereby increasing the effectiveness of the sediment basin. The purpose of this procedure is to prescribe the parameters, procedures and methods of determining and modifying the shape of the basin.

The length of the flow path (L) is the distance from the point of inflow to the riser (outflow point). The point of inflow is the point that the stream enters the normal pool (pool level at the riser crest elevation). The pool area (A) is the area of the normal pool. The effective width (We) is equal to the Area (A) divided by the length (L). The length to width ratio (L:W) is found by the equation:

$$L:W = A/We \text{ where } We = A/L$$

In the event there is more than one inflow point, *any inflow point that conveys more than 30 percent of the total peak inflow rate shall meet the length-width ratio criteria.*

The required basin shape may be obtained by proper site selection, by excavation, or by constructing a baffle in the basin. The purpose of the baffle is to increase the effective flow length from the inflow point to the riser. Baffles shall be placed mid-way between the inflow point and the riser. The baffle length shall be as required to provide the minimum 2:1 length-width ratio. The effective length (Le) shall be the shortest distance the water must flow from the inflow point around the end of the baffle to the outflow point. Then:

$$L:W = Le/We \text{ where } We = A/Le$$

Three examples are shown on the following pages. Note that for the special case in example C the water is allowed to go around both ends of the baffle and the effective length,  $Le = L1a + L1b = L2a + L2d$ . Otherwise, the length-width ratio computations are the same as shown above. This special case procedure for computing Le is allowable only when the two flow paths are equal, *i.e.*, when  $L1 = L2$ . A baffle detail is also shown. For examples of sediment basin baffles, refer to Figure 6-29.2.

The dimensions necessary to obtain the required basin volume and surface area shall be clearly shown on the plans to facilitate plan review, construction and inspection.

#### **Spillways**

Runoff may be computed by the method outlined in Appendix A. Other approved equivalent methods may be used. Runoff computations shall be based upon the worst soil-cover conditions expected to prevail in the contributing drainage area during the anticipated effective life of the structure. *The combined capacities of the principal and emergency spillway shall be sufficient to pass the peak rate of runoff from a 25-year, 24-hour frequency storm.* Even if the principal spillway is designed to convey the peak rate of runoff from a 25-year, 24-hour storm, an emergency spillway shall be present.

1. **Principal spillway** - A spillway consisting of a vertical pipe or box type riser joined (watertight connection) to a pipe that shall extend through the embankment and an outlet beyond the downstream toe of the fill shall be provided. See Figure 6-29.3. The metal gauge thickness shall comply with DOT or NRCS specifications. The discharge shall be based on a 2-year, 24-hour storm for the total drainage area without causing flow through the emergency spillway. The appropriate disturbed soil cover condition shall be used. *The minimum size of the pipe shall be 8 inches in diameter.* Principal spillway capacities may be determined from Table 6-29.1. Weir flow discharge above the crest of the riser may be determined from Table 6-29.2. Principal spillway pipe, riser pipe, and trash rack proportions are shown in Table 6-29.2.
  - a. **Crest elevation** - The crest elevation of the riser shall be a minimum of one foot

below the elevation of the control section of the emergency spillway.

- b. **Watertight barrel assembly** - The riser and all pipe connections shall be completely water tight except for the inlet opening at the top or dewatering openings, and shall not have any other holes, leaks, rips or perforations.
- c. **Dewatering the basin** - Retention time within the basin is an important factor in effective sediment retention. The method used to dewater the sediment basin may be selected from the following two methods:

*Perforated Riser Pipe* - The perforated riser pipe is the conventional method for dewatering a sediment basin. The lower half of the riser is perforated with 1/2-inch holes spaced approximately 3-inches apart. It is covered with two feet of 3 to 4 inch stone.

*Skimmer Outlet* - The skimmer-type dewatering device operates at the surface of the ponded water and will not withdraw sediment from the submerged volume of the basin. As compared to conventional perforated risers, skimmers discharge a 45 percent less mass of sediment. However, skimmers are mechanically more complex and will require frequent inspection and maintenance in order to operate as designed. Refer to specification **Sk-Floating Surface Skimmer**.

- d. **Trash rack and anti-vortex device** - A trash rack and anti-vortex device shall be securely installed on top of the riser and may be the type as shown in Figure 6-29.4.
- e. **Base** - The riser shall have a base attached with a watertight connection and shall have sufficient weight to prevent flotation of the riser. *A concrete base 18" thick with the riser embedded 9-inches in the base is recommended.* Computations shall be made to design a base that will prevent flotation. See Figure 6-29.5 and Table 6-29.3 for details.
- f. **Anti-Seep Collars** - One anti-seep collar shall be installed around the pipe, near the center of the dam, when **any** of the following conditions exist:
  - 1. The settled height of the dam is greater

than 15 feet.

- 2. The conduit is smooth pipe larger than 8" in diameter.
- 3. The conduit is corrugated metal pipe larger than 12" in diameter.

Use an anti-seep collar with an 18-inch projection for heads (H) less than or equal to 10 feet and a 24-inch projection for heads (H) greater than 10 feet. The anti-seep collar and its connection shall be watertight.

- g. **Outlet** - An outlet shall be provided, including a means of conveying the discharge in an erosion-free manner to an existing stable area. Where discharge occurs at the property line, drainage easements will be obtained in accordance with local ordinances. Adequate notes and references will be shown on the erosion and sediment control plan. Protection against scour at the discharge end of the pipe spillway shall be provided. Measures may include excavated plunge pools, riprap, impact basins, revetments, or other approved methods. Refer to specification **St - Storm Drain Outlet Protection**.
- h. For typical features of a temporary sediment basin, see Figure 6-29.1.

- 2. **Emergency Spillway** - *The entire flow area of the emergency spillway shall be constructed in undisturbed ground (not fill).* The emergency spillway cross-section shall be trapezoidal with a minimum bottom width of eight feet. This spillway channel shall have a straight control section of at least 20 feet in length and a straight outlet section for a minimum distance equal to 25 feet. See Figure 6-30.6.
  - a. **Capacity** - The minimum capacity of the emergency spillway shall be that *required to pass the peak rate of runoff from the 25-year, 24-hour frequency storm, less any reduction due to flow in the principal spillway.* The appropriate disturbed soil cover condition shall be used. Emergency spillway dimensions may be determined by using the method described in this section. Refer to Table 6-29.4 and Figure



6-29.6.

- b. **Velocities** - *The velocity of flow in the exit channel shall not exceed 5 feet per second for vegetated channels.* For channels with erosion protection other than vegetation, velocities shall be within the non-erosive range for the type of protection used. Vegetation, riprap, asphalt or concrete shall be provided to prevent erosion. Refer to specification **Ch - Channel Stabilization**.
- c. **Freeboard** - Freeboard is the difference between the design high water elevation in the emergency spillway and the top of the settled embankment. *The freeboard shall be at least one foot.*

### **Entrance of Runoff Into Basin**

Points of entrance of surface runoff into excavated sediment basins shall be protected to prevent erosion and sediment generation. Dikes, swales, or other water control devices, shall be installed as necessary to direct runoff into the basin. Points of runoff entry should be located as far away from the riser as possible, to maximize travel time. Refer to **St - Storm Drain Outlet Protection**.

## **CONSTRUCTION SPECIFICATIONS**

### **Site Preparation**

Areas under the embankment and under structural works shall be cleared, grubbed, and stripped of top-soil. All trees, vegetation, roots and other objectionable material shall be removed and disposed of by approved methods. In order to facilitate clean-out or restoration, the pool area (measured at the top of the pipe spillway) will be cleared of all brush and trees.

### **Cut-off Trench**

A cut-off trench will be excavated along the center-line of earth fill embankments. *The minimum depth shall be 2 feet.* The cut-off trench shall extend up both abutments to the riser crest elevation. The minimum bottom width shall be 4 feet, but wide enough to permit operation of compaction equipment. The side slopes shall be no steeper than 1:1. Compaction requirements shall be the same as those for the embankment. The trench shall be drained during the backfilling and compaction operations.

### **Embankment**

The fill material shall be taken from approved areas shown on the plans. It shall be clean mineral soil free of roots, woody vegetation, oversized stones, rocks or other objectionable material. Relatively pervious materials such as sand or gravel (Unified Soil Classes GW, GP, SW & SP) shall be placed in the downstream section of the embankment. Areas on which fills are to be placed shall be scarified prior to placement of fill. The fill material shall contain sufficient moisture so that it can be formed by hand into a ball without crumbling. If water can be squeezed out of the ball, it is too wet for proper compaction. *Fill material shall be placed in six-inch to eight-inch thick continuous layers over the entire length of the fill.* Compaction shall be obtained by routing and hauling the construction equipment over the fill so that the entire surface of the fill is traversed by at least one wheel or tread track of the equipment or by the use of a compactor. *The embankment shall be constructed to an elevation 5 percent higher than the design height to allow for settlement.*

### **Principal Spillway**

The riser shall be securely attached to the pipe or pipe stub by welding the full circumference making a watertight structural connection. The pipe stub must be attached to the riser at the same percent (angle) of grade as the outlet conduit. The connection between the riser and the riser base shall be watertight. All connections between pipe sections must be achieved by approved watertight band assemblies. The pipe and riser shall be placed on a firm, smooth foundation of impervious soil as the embankment is constructed. Breaching the embankment is unacceptable. Pervious materials such as sand, gravel, or crushed stone shall not be used as backfill around the pipe or anti-seep collar. *The fill material around the pipe spillway shall be placed in four inch layers and compacted under and around the pipe to at least the same density as the adjacent embankment.* Care must be taken not to raise the pipe from firm contact with its foundation when compacting under the pipe haunches. A minimum depth of two feet of hand compacted backfill shall be placed over the pipe spillway before crossing it with construction equipment.

## **Emergency Spillway**

**The emergency spillway shall be installed in undisturbed ground.** The achievement of planned elevations, grades, design width, entrance and exit channel slopes are critical to the successful operation of the emergency spillway and must be constructed within a tolerance of  $\pm$  0.2 feet. If the emergency spillway requires erosion protection other than vegetation, *the lining shall not compromise the capacity of the emergency spillway, e.g. the emergency spillway shall be over-excavated so that the lining will be flush with the slope surface.*

## **Vegetative Treatment**

Stabilize the embankment and all other disturbed areas in accordance with the appropriate permanent vegetative measure, Ds3, immediately following construction. *In no case shall the embankment remain unstabilized for more than seven (7) days.* Refer to specifications **Ds2 Disturbed Area Stabilization (Temporary Seeding)** , **Ds3 - Disturbed Area Stabilization (Permanent Vegetation)** and **Ds4 - Disturbed Area Stabilization (With Sodding)** respectively.

## **Erosion and Pollution Control**

Construction operations will be carried out in such a manner that erosion and water pollution will be minimized. State and local law concerning pollution abatement shall be complied with.

## **Safety**

State and local requirements shall be met concerning fencing and signs warning the public of hazards of soft sediment and floodwater.

## **MAINTENANCE**

Repair all damages caused by soil erosion or construction equipment at or before the end of each working day.

Sediment shall be removed from the basin when it reaches the specified distance below the top of the riser. *Sediment shall not enter adjacent streams or drainageways during sediment removal or disposal.* The sediment shall not be deposited downstream from the embankment, adjacent to a stream or floodplain.

## **FINAL DISPOSAL**

When temporary structures have served their intended purpose and the contributing drainage

area has been properly stabilized, the embankment and resulting sediment deposits are to be leveled or otherwise disposed of in accordance with approved sediment control plan. The proposed use of a sediment basin site will often dictate final disposition of the basin and any sediment contained therein. *If the site is scheduled for future construction, then the embankment and trapped sediment must be removed, safely disposed of, and backfilled with a structural fill.* When the basin area is to remain open space, the pond may be pumped dry, graded and back-filled.

**TO BE SUBMITTED WITH/ON  
THE EROSION, SEDIMENTATION AND POLLUTION CONTROL PLAN**

**On the ES&PC Plan**

1. The specific location of the basin, showing existing and proposed contours.
2. Maintenance equipment access points.
3. Completed Figures 6-29.7 and 6-29.8. (details for the cross section of dam, principal spillway, and emergency spillway, and profile of emergency spillway).
4. Details of trash rack, concrete riser base, and outlet structure assembly. (Refer to Figures 6-29.4 to 6-29.6)

**On 8 1/2" x 11" Sheet(s)**

1. Hydrological study, including information regarding stage/storage relationship.
2. Temporary sediment basin design sheet, p.6-231 to 6-233.
3. Completed Figures 6-29.7 and 6-29.8 (details for the cross section of the dam, principal spillway, and emergency spillway, and profile of emergency spillway).

# BASIC COMPONENTS OF TEMPORARY SEDIMENT BASIN

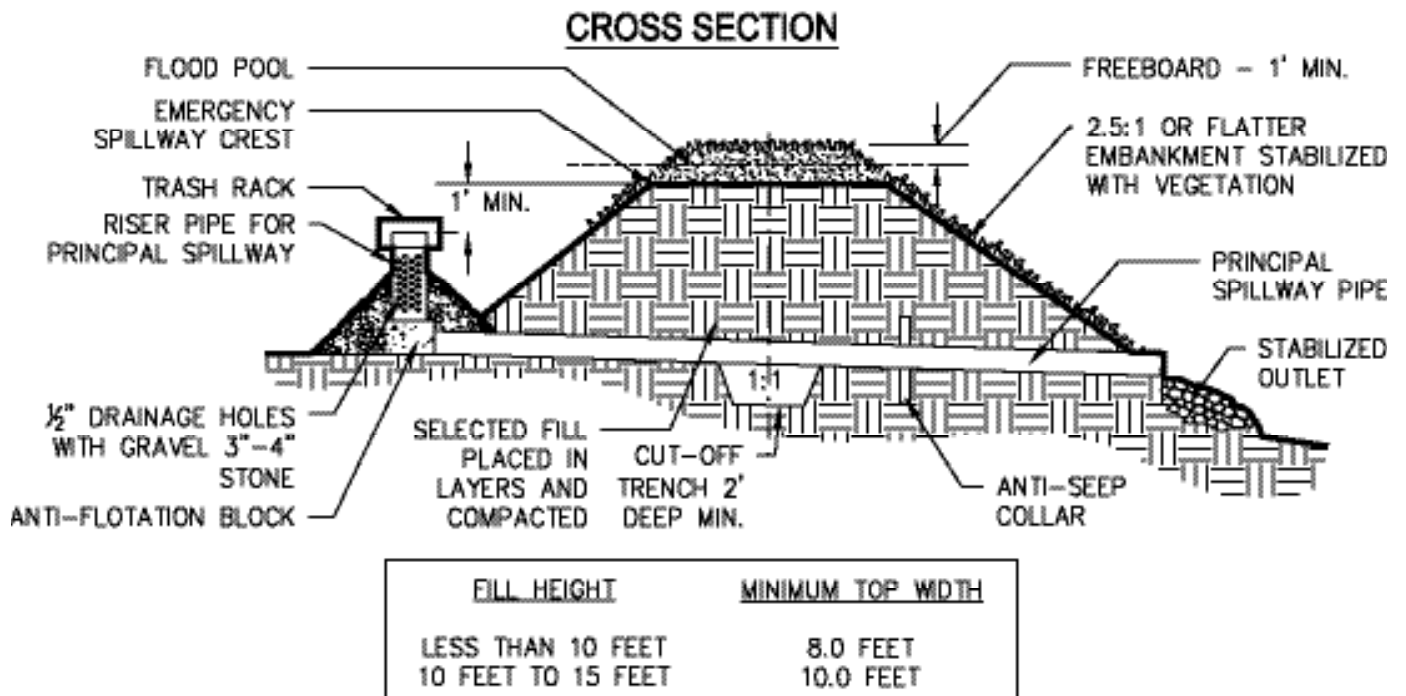

## PLAN VIEW

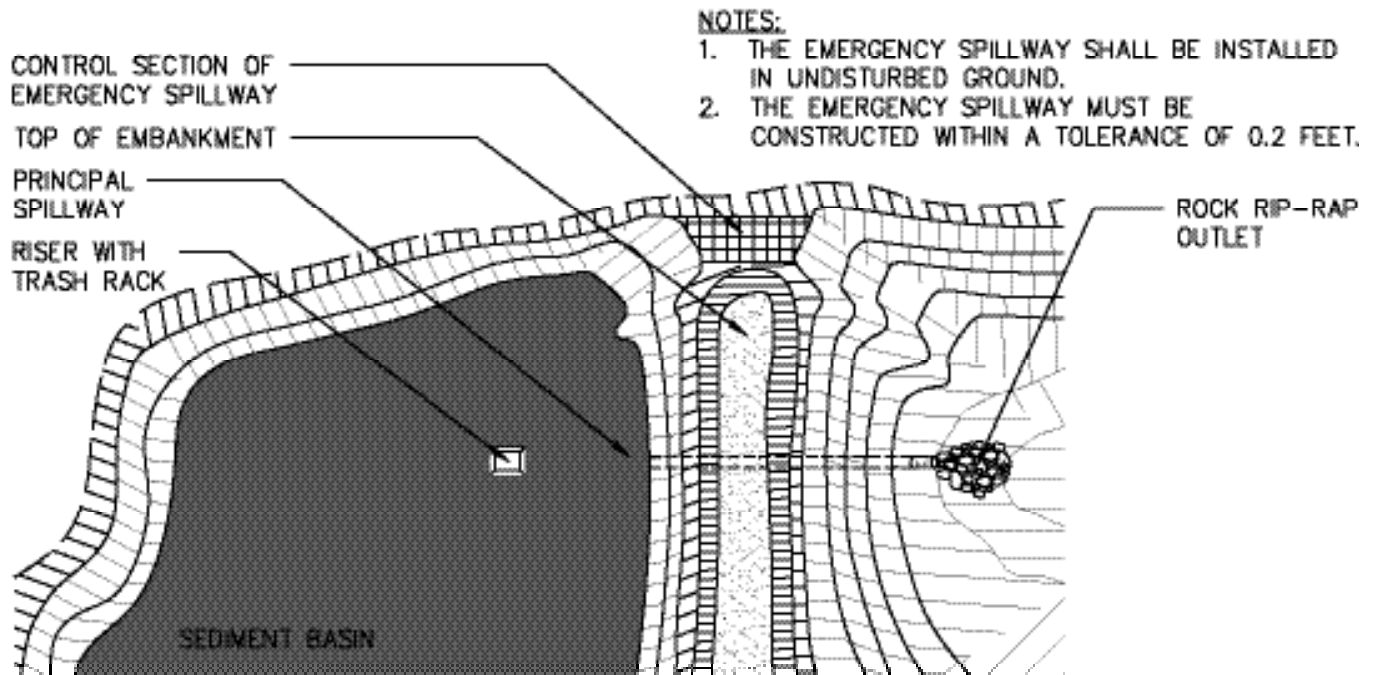

Figure 6-29.1

**EXAMPLES: PLAN VIEWS (NOT TO SCALE)**

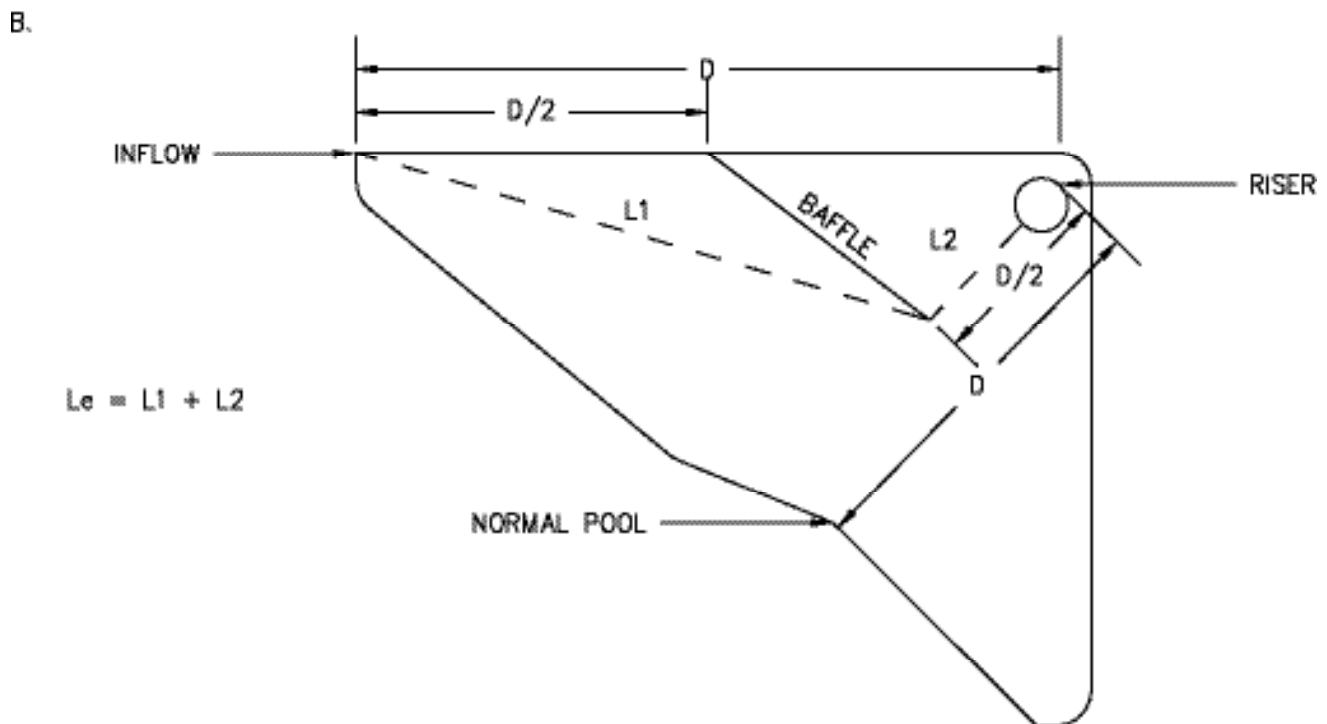
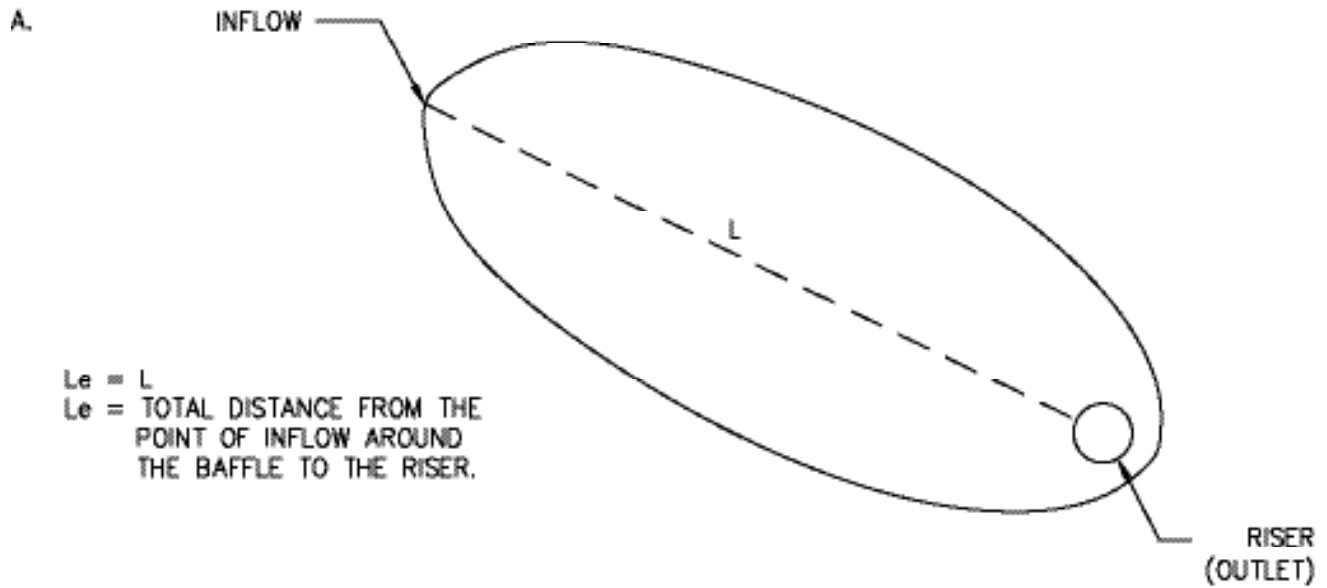

Figure 6-29.2 Baffles (Sheet 1 of 2)

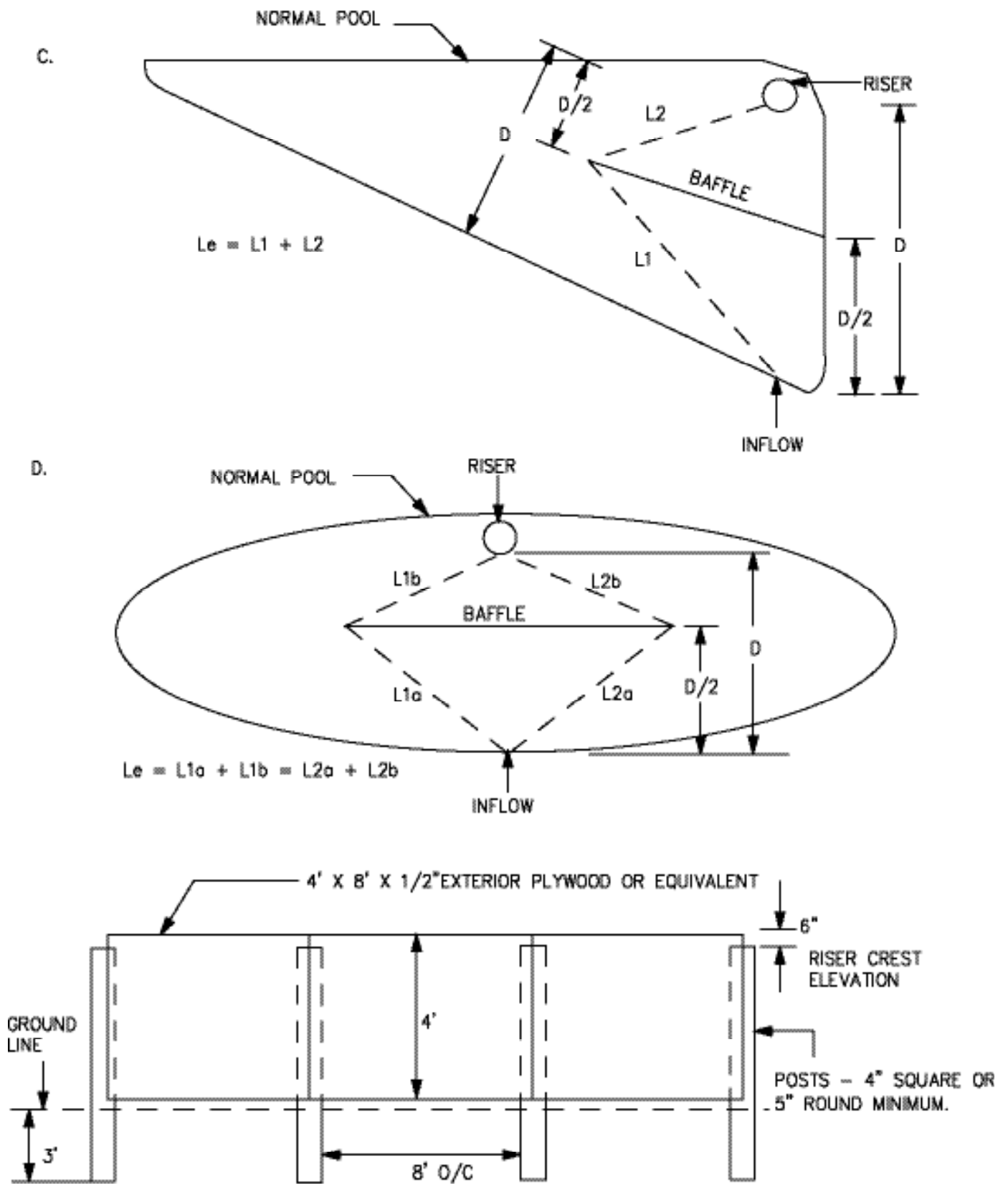
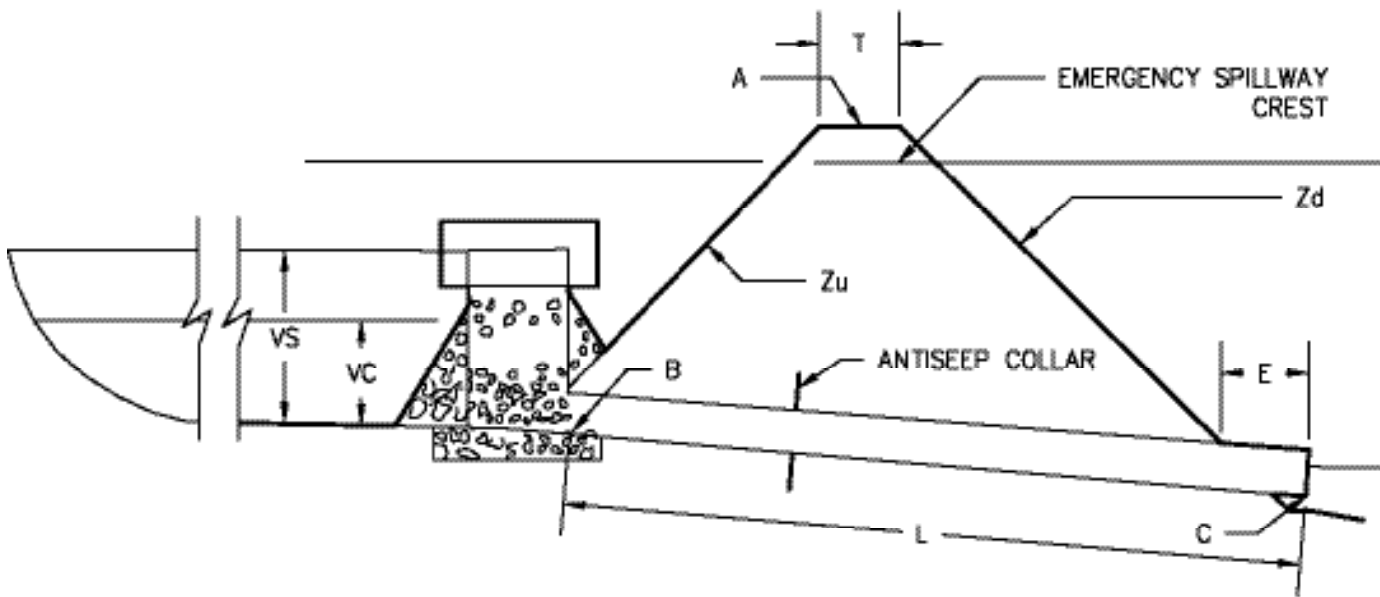

Figure 6-29.2 (Sheet 2)



A = TOP OF DAM ELEVATION

B = LOWEST ELEVATION OF PIPE AT RISER

C = LOWEST ELEVATION OF PIPE AT OUTLET

E = EXTENDED LENGTH OF PIPE BEYOND TOE OF DAM

L = TOTAL LENGTH OF PIPE, FT.

$L = [ A - (B + C) / 2 ] [ Z_U + Z_D ] + T + E$

T = TOP WIDTH OF DAM, FT.

Z<sub>u</sub> = UPSTREAM SIDE SLOPE

Z<sub>d</sub> = DOWNSTREAM SIDE SLOPE

Figure 6-29.3 Principle Spillway

**Table 6-29.1. Pipe Flow Chart For Corrugated Metal Pipe Drop Inlet Principal Spillway Conduit**

For Corrugated Metal Pipe Inlet  $K_m = K_a + K_b = 1.0$  and 70 Feet of  
 Corrugated Metal Conduit (full flow assumed),  $n = 0.025$   
 (Note correction factors for pipe lengths other than 70 feet)

Diameter Of Pipe In Inches								
H, in feet	8"	12"	18"	24"	30"	36"	42"	48"
Discharge In Cubic Feet Per Second								
3	1.22	3.43	9.48	19.1	32.6	49.9	71.2	96.5
4	1.40	3.97	10.9	22.1	37.6	57.7	82.3	111
5	1.57	4.43	12.2	24.7	42.1	64.5	92.0	125
6	1.72	4.86	13.4	27.0	46.1	70.6	101	136
7	1.86	5.25	14.5	29.2	49.8	76.3	109	147
8	1.99	5.61	15.5	31.2	53.2	81.5	116	158
9	2.11	5.95	16.4	33.1	56.4	86.5	123	167
10	2.22	6.27	17.3	34.9	59.5	91.2	130	176
11	2.33	6.58	18.2	36.6	62.4	95.6	136	185
12	2.43	6.87	19.0	38.2	65.2	99.9	142	193
13	2.53	7.15	19.7	39.8	67.8	104	148	201
14	2.63	7.42	20.5	41.3	70.4	108	154	208
15	2.72	7.68	21.2	42.8	72.8	112	159	216
16	2.81	7.93	21.9	44.2	75.2	115	165	223
17	2.90	8.18	22.6	45.5	77.5	119	170	230
18	2.98	8.41	23.2	46.8	79.8	120	174	236
19	3.06	8.64	23.9	48.1	82.0	126	179	243
20	3.14	8.87	24.5	49.4	84.1	129	184	249
Correction Factors For Other Pipe Lengths								
L, in feet								
30	1.41	1.36	1.29	1.24	1.21	1.18	1.15	1.13
40	1.27	1.23	1.20	1.17	1.14	1.12	1.11	1.10
50	1.16	1.14	1.12	1.10	1.09	1.08	1.07	1.06
60	1.07	1.06	1.05	1.05	1.04	1.04	1.03	1.03
70	1.00	1.00	1.00	1.00	1.00	1.00	1.00	1.00
80	0.94	0.95	0.95	0.96	0.96	0.97	0.97	0.97
90	0.89	0.90	0.91	0.92	0.93	0.94	0.94	0.95
100	0.85	0.86	0.88	0.89	0.90	0.91	0.92	0.93
120	0.79	0.90	0.82	0.83	0.85	0.86	0.87	0.89
140	0.73	0.75	0.77	0.79	0.81	0.82	0.84	0.85
160	0.69	0.70	0.73	0.75	0.77	0.79	0.80	0.82



HEAD-h in feet	12	18	24	30	36	48	54	60	HEAD-h in feet
	<u>Flow In Cubic Feet Per Second</u>								
0.1	0.3	0.5	0.6	0.8	0.9	1.2	1.4	1.5	0.1
0.2	0.9	1.3	1.7	2.2	2.6	3.5	3.9	4.4	0.2
0.3	1.6	2.4	3.2	4.0	4.8	6.4	7.2	8.0	0.3
0.4	2.5	3.7	4.9	6.2	7.4	9.9	11.1	12.3	0.4
0.6	4.5	6.8	9.1	11.3	13.6	18.1	20.4	22.6	0.6
0.8		10.5	13.9	17.4	20.9	27.9	31.4	34.8	0.8
1.0			19.5	24.3	29.2	39.0	43.8	48.7	1.0
1.2			25.6	32.0	38.4	51.2	57.6	64.0	1.2
1.4				40.3	48.4	64.5	72.6	80.7	1.4
1.6				49.3	59.1	78.8	88.7	98.6	1.6
1.8					70.6	94.1	105.8	117.6	1.8
2.0					82.6	110.2	124.0	137.7	2.0
2.2						127.1	143.0	158.9	2.2
2.4							162.9	181.0	2.4
2.6							183.7	204.1	2.6
2.8								228.1	2.8
3.0								253.0	3.0

Table 6-29.2

Pipe, Riser, and Trash Rack Proportions

Eq. 6-10  $D_r \geq (1.50) (D_{ps})$   
 where  $D_r$  = diameter of riser  
 $D_{ps}$  = diameter of principal spillway

Eq. 6-11  $D_t \geq (1.4) (D_r)$   
 where  $D_t$  = diameter of trash rack  
 $D_r$  = diameter of riser

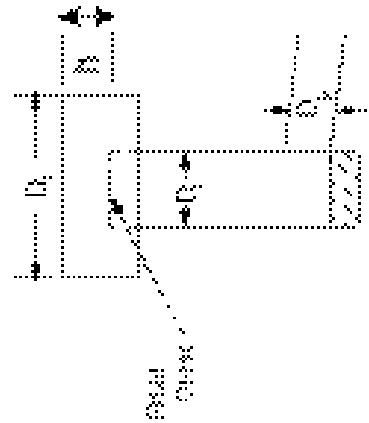

Equation 6-10:  $D_r \geq (1.50) (D_{ps})$   
 Equation 6-11:  $D_t \geq (1.4) (D_r)$   
 where  $D_r$  = diameter of riser  
 $D_{ps}$  = diameter of principal spillway  
 $D_t$  = diameter of trash rack  
 $D_r$  = diameter of riser

Eq. 6-10:  $D_r \geq (1.50) (D_{ps})$

Eq. 6-11:  $D_t \geq (1.4) (D_r)$

Eq. 6-11:  $D_t \geq (1.4) (D_r)$

Eq. 6-11:  $D_t \geq (1.4) (D_r)$

Eq. 6-11:  $D_t \geq (1.4) (D_r)$

Eq. 6-11:  $D_t \geq (1.4) (D_r)$

NOTE: The minimum diameter of the trash rack should be determined based on the design flow rate and the design head.

## TYPICAL TRASH RACK

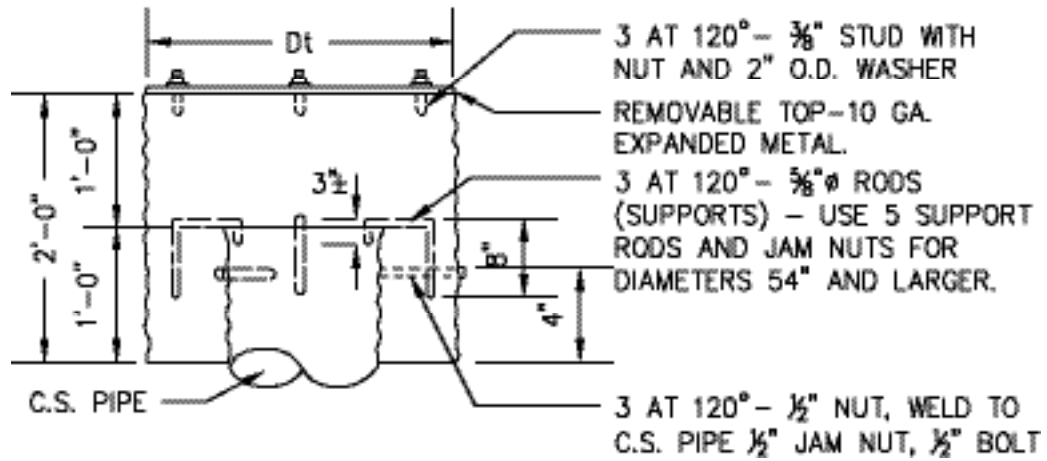

Figure 6-29.4

## CONCRETE RISER BASE DETAIL

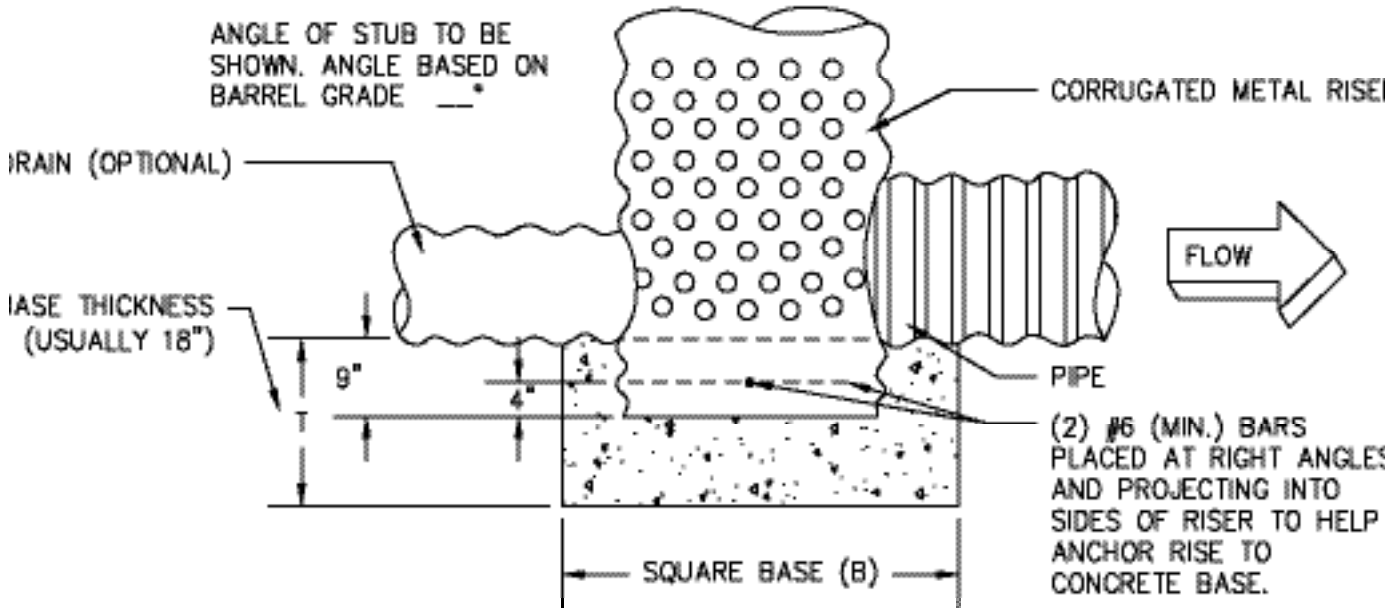

Figure 6-29.5

Riser Pipe Diameter (in)	Bouoyant Force (lbs / V.F. of Riser Height) <sup>1</sup>	Volume of Concrete per Vertical Foot of Riser Height (c.f. / V. F.) Needed to Prevent Flotation <sup>2</sup>
12	49.0	0.69
18	110.3	1.54
21	150.1	2.10
24	196.0	2.75
30	306.3	4.29
36	441.1	6.18
48	784.1	10.98
54	992.4	13.90
60	1225.2	17.16

EXAMPLE: Find the volume of concrete required to stabilize a 24 inch diameter riser 10 feet high.

$$\text{VOL.} = (2.75 \text{ cu.ft./V.F.}) (10 \text{ feet}) = 27.5 \text{ cu. ft.} = 1 \text{ cu. yd.}$$

### CONCRETE VOLUME REQUIRED TO PREVENT FLOTATION OF RISER

Table 6-29.3

# EXCAVATED EARTH SPILLWAY – PLAN VIEW

## TYPICAL SPILLWAY

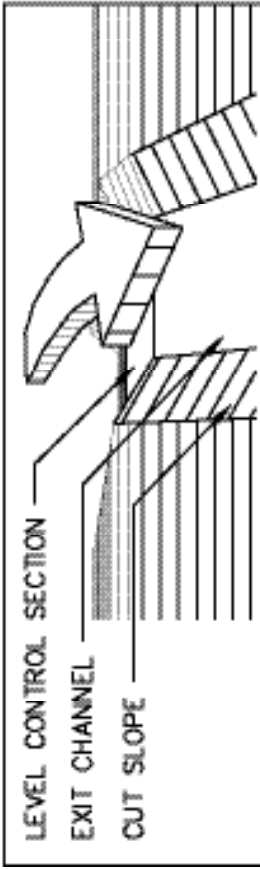
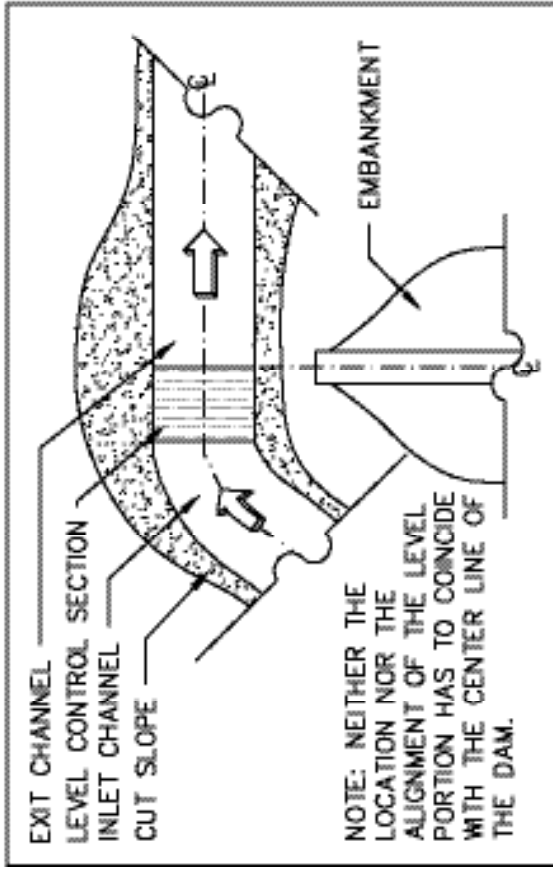

## WING DIKE SPILLWAY

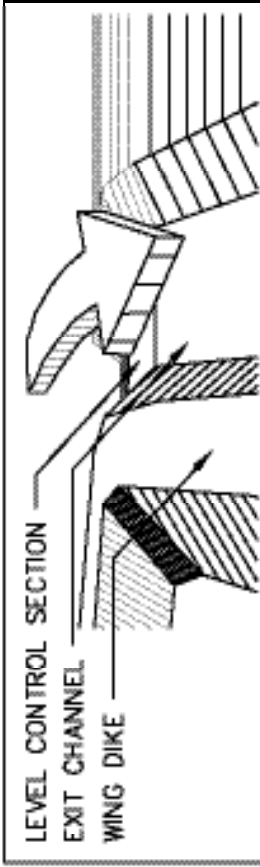
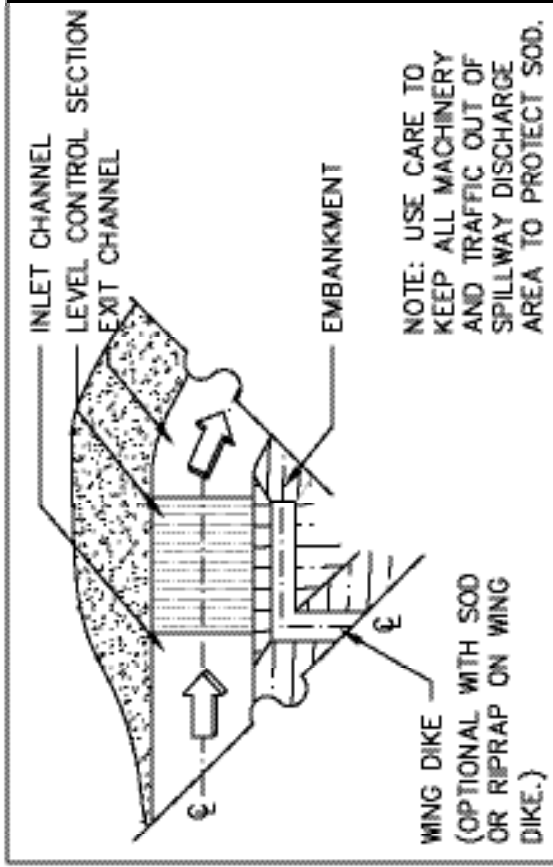

## PROFILE ALONG CENTERLINE



## CROSS-SECTION OF CONTROL SECTION

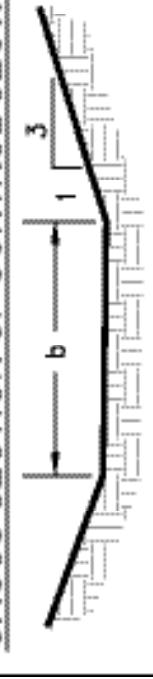

## LEGEND:

- $H_p$  = DIFFERENCE IN ELEVATION BETWEEN CREST OF EARTH SPILLWAY AT THE CONTROL SECTION AND WATER SURFACE IN THE RESERVOIR (IN FEET).
- $b$  = BOTTOM WIDTH OF EARTH SPILLWAY AT THE CONTROL SECTION (IN FEET) SEE TABLE 6-22.4
- $Q$  = TOTAL DISCHARGE (IN CFS.)
- $V$  = VELOCITY (IN FEET PER SECOND) THAT WILL EXIST IN CHANNEL BELOW CONTROL SECTION, AT DESIGN  $Q$ , IF CONSTRUCTED TO SLOPE ( $S$ ) THAT IS SHOWN (TABLE 6-22.4)
- $S$  = FLATTEST SLOPE (IN %) ALLOWABLE FOR CHANNEL BELOW CONTROL SECTION (TABLE 6-22.4)
- $S_e$  = ENTRY SLOPE
- $S_o$  = EXIT SLOPE

## NOTES:

1. FOR  $Q$ ,  $V$ , AND  $S$  RELATIONSHIPS, SEE THE CHART ON THE FOLLOWING PAGE.
2. FOR A GIVEN  $H_p$ , A DECREASE IN THE EXIT SLOPE AS GIVEN IN THE TABLE DECREASES SPILLWAY DISCHARGE, BUT INCREASING THE EXIT SLOPE FROM  $S$  DOES NOT INCREASE DISCHARGE. IF AN EXIT SLOPE ( $S_o$ ) IS STEEPER THAN  $S$  IS USED, THE VELOCITY ( $V_o$ ) IN THE EXIT CHANNEL WILL INCREASE ACCORDING TO THE FOLLOWING RELATIONSHIP:

$$V_o = V (S_o/S)^{0.3}$$

Figure 6-29.6



## DESIGN DATA FOR EARTH SPILLWAYS

DEPTH (ft) IN FEET	SPILLWAY VARIABLES	BOTTOM WIDTH (ft) IN FEET																	
		8	10	12	14	16	18	20	22	24	26	28	30	32	34	36	38	40	
0.5	Q	8	7	6	6	11	12	14	16	17	18	20	21	22	24	25	27	28	
	V	2.7	2.7	2.7	2.7	2.7	2.7	2.7	2.7	2.7	2.7	2.7	2.7	2.7	2.7	2.7	2.7	2.7	
	S	2.9	2.9	2.9	2.9	2.8	2.8	2.8	2.8	2.8	2.8	2.8	2.8	2.8	2.8	2.8	2.8	2.8	
0.6	Q	8	10	12	14	16	18	20	22	24	26	28	30	32	34	36	37	38	
	V	2.0	2.0	2.0	2.0	2.0	2.0	2.0	2.0	2.0	2.0	2.0	2.0	2.0	2.0	2.0	2.0	2.0	
	S	2.7	2.7	2.7	2.7	2.6	2.7	2.6	2.6	2.6	2.6	2.6	2.6	2.6	2.6	2.6	2.6	2.6	
0.7	Q	11	12	14	16	20	22	26	28	30	32	36	38	41	42	44	44	44	
	V	2.2	2.2	2.2	2.2	2.2	2.2	2.2	2.2	2.2	2.2	2.2	2.2	2.2	2.2	2.2	2.2	2.2	
	S	2.5	2.5	2.4	2.4	2.4	2.4	2.4	2.4	2.4	2.4	2.4	2.4	2.4	2.4	2.4	2.4	2.4	
0.8	Q	12	14	16	22	26	28	32	36	38	42	46	48	48	51	54	57	58	
	V	2.5	2.5	2.5	2.5	2.5	2.5	2.5	2.5	2.5	2.5	2.5	2.5	2.5	2.5	2.5	2.5	2.5	
	S	2.8	2.8	2.8	2.2	2.2	2.2	2.2	2.2	2.2	2.2	2.2	2.2	2.2	2.2	2.2	2.2	2.2	
0.9	Q	17	20	24	28	32	36	38	42	47	51	52	57	60	64	68	71	76	
	V	2.7	2.5	2.5	2.5	2.5	2.5	2.5	2.5	2.5	2.5	2.5	2.5	2.5	2.5	2.5	2.5	2.5	
	S	2.2	2.1	2.1	2.1	2.1	2.1	2.1	2.1	2.1	2.1	2.1	2.1	2.1	2.1	2.1	2.1	2.1	
1.0	Q	20	24	28	32	38	42	47	51	52	58	62	68	72	77	81	84	88	
	V	4.0	4.0	4.0	4.0	4.0	4.0	4.0	4.0	4.0	4.0	4.0	4.0	4.0	4.0	4.0	4.0	4.0	
	S	2.1	2.0	2.0	2.0	2.0	2.0	2.0	2.0	2.0	2.0	2.0	2.0	2.0	2.0	2.0	2.0	2.0	
1.1	Q	22	28	34	38	44	48	54	58	66	70	74	78	84	88	96	100	106	
	V	4.2	4.2	4.2	4.2	4.2	4.2	4.2	4.2	4.2	4.2	4.2	4.2	4.2	4.2	4.2	4.2	4.2	
	S	2.9	2.9	2.9	2.9	2.9	2.9	2.9	2.9	2.9	2.8	2.8	2.8	2.8	2.8	2.8	2.8	2.8	
1.2	Q	22	32	40	46	51	58	64	68	78	84	88	96	104	110	118	122	128	
	V	4.4	4.4	4.4	4.4	4.4	4.5	4.5	4.5	4.5	4.5	4.5	4.5	4.5	4.5	4.5	4.5	4.5	
	S	2.9	2.9	2.8	2.8	2.8	2.8	2.8	2.8	2.8	2.8	2.8	2.8	2.8	2.8	2.8	2.8	2.8	
1.3	Q	32	38	44	52	58	66	72	80	84	94	100	108	112	118	126	132	140	
	V	4.5	4.6	4.6	4.6	4.6	4.6	4.7	4.7	4.7	4.7	4.7	4.7	4.7	4.7	4.7	4.7	4.7	
	S	2.8	2.8	2.8	2.7	2.7	2.7	2.7	2.7	2.7	2.7	2.7	2.7	2.7	2.7	2.7	2.7	2.7	
1.4	Q	37	44	51	58	64	74	82	88	94	108	111	118	127	134	142	150	158	
	V	4.7	4.8	4.8	4.8	4.8	4.8	4.8	4.8	4.8	4.9	4.9	4.9	4.9	4.9	4.9	4.9	4.9	
	S	2.8	2.7	2.7	2.7	2.7	2.7	2.7	2.6	2.6	2.6	2.6	2.6	2.6	2.6	2.6	2.6	2.6	
1.5	Q	41	50	58	64	76	86	92	104	108	118	126	132	142	150	158	166	174	
	V	4.8	4.9	4.9	5.0	5.0	5.0	5.0	5.0	5.0	5.0	5.0	5.0	5.0	5.0	5.0	5.1	5.1	
	S	2.7	2.7	2.6	2.6	2.6	2.6	2.6	2.6	2.6	2.6	2.6	2.6	2.6	2.6	2.6	2.5	2.5	
1.6	Q	44	54	66	76	84	94	104	112	122	132	142	148	158	168	178	187	197	
	V	5.0	5.1	5.1	5.1	5.1	5.2	5.2	5.2	5.2	5.2	5.2	5.2	5.2	5.2	5.2	5.2	5.2	
	S	2.6	2.6	2.6	2.6	2.5	2.5	2.5	2.5	2.5	2.5	2.5	2.5	2.5	2.5	2.5	2.5	2.5	
1.7	Q	52	62	72	82	94	106	116	128	136	146	154	167	176	187	194	204	217	
	V	5.2	5.2	5.2	5.2	5.2	5.2	5.2	5.2	5.4	5.4	5.4	5.4	5.4	5.4	5.4	5.4	5.4	
	S	2.6	2.6	2.5	2.5	2.5	2.5	2.5	2.5	2.5	2.5	2.5	2.5	2.5	2.5	2.5	2.5	2.5	
1.8	Q	58	68	81	94	104	118	127	138	150	160	171	182	194	204	214	224	233	
	V	5.2	5.4	5.4	5.5	5.5	5.5	5.5	5.5	5.5	5.5	5.5	5.5	5.5	5.5	5.5	5.5	5.5	
	S	2.5	2.5	2.5	2.5	2.4	2.4	2.4	2.4	2.4	2.4	2.4	2.4	2.4	2.4	2.4	2.4	2.4	
1.9	Q	64	78	90	102	114	127	140	152	164	176	188	204	218	226	236	244	254	
	V	5.5	5.5	5.5	5.6	5.6	5.6	5.7	5.7	5.7	5.7	5.7	5.7	5.7	5.7	5.7	5.7	5.7	
	S	2.5	2.5	2.5	2.4	2.4	2.4	2.4	2.4	2.4	2.4	2.4	2.4	2.4	2.4	2.4	2.4	2.4	
2.0	Q	71	82	97	111	126	138	153	164	178	190	204	218	232	246	254	264	273	
	V	5.6	5.7	5.7	5.7	5.8	5.8	5.8	5.8	5.8	5.8	5.8	5.8	5.9	5.9	5.9	5.9	5.9	
	S	2.5	2.4	2.4	2.4	2.4	2.4	2.4	2.4	2.4	2.5	2.5	2.5	2.5	2.5	2.5	2.5	2.5	
2.1	Q	77	94	107	122	136	148	162	177	192	207	222	234	250	257	270	284	296	
	V	5.7	5.8	5.9	5.9	5.9	5.9	5.9	5.9	6.0	6.0	6.0	6.0	6.0	6.0	6.0	6.0	6.0	
	S	2.4	2.4	2.4	2.4	2.4	2.4	2.4	2.4	2.4	2.4	2.4	2.4	2.4	2.4	2.4	2.4	2.4	

**DATA TO RIGHT OF HEAVY VERTICAL LINES SHOULD BE USED WITH CAUTION, AS THE RESULTING SECTIONS WILL BE EITHER POORLY PROPORTIONED, OR HAVE VELOCITIES IN EXCESS OF 6 FEET PER SECOND.**

Source: USDA-SCS

Table 6-29.4



## TEMPORARY SEDIMENT BASIN DESIGN DATA SHEET

### EXAMPLE PROBLEM

Computed by \_\_\_\_\_ Date \_\_\_\_\_  
Checked by \_\_\_\_\_ Date \_\_\_\_\_

Project Name Independence School, Paradise City

Basin No. 1

Total area draining to basin = 18.1 acres

Disturbed area draining to basin = 18.1 acres

#### Volume

1. Compute minimum required storage volume ( $V_s$ )  
 $V_s = 67 \text{ cy/ac} * 18.1 \text{ acres} = 1212.7 \text{ cy}$
2. Compute volume of basin at clean-out ( $V_c$ )  
 $V_c = 22 \text{ cy/ac} * 18.1 \text{ acres} = 398.2 \text{ cy}$
3. Determine elevation corresponding to minimum required storage volume,  $V_s$   
Minimum riser crest elevation = 1052.5 ft (determined by stage/storage relationship)
4. Determine elevation corresponding to clean-out volume,  $V_c$   
Clean-out elevation = 1051.9 ft (determined by stage/storage relationship)  
Note: Clean-out elevation shall be clearly marked on the riser or marked by a post near the riser.
5. Compute length of riser  
Riser length = Minimum elevation of riser crest - Lowest elevation of pipe at riser  
Riser length = 1052.5 ft - 1050.0 ft  
Riser length = 2.5 ft

#### Stormwater Runoff

6. Compute peak discharge from a 2-yr, 24-hr storm event.  
 $Q_2 = 26$  cfs (Attach runoff computation sheet.)
7. Compute peak discharge from a 25-yr, 24-hr storm event.  
 $Q_{25} = 46$  cfs (Attach runoff computation sheet.)

#### Surface Area/Configuration Design

8. Compute minimum basin surface area ( $SA_{min}$ )  
 $SA_{min} = 0.01 \text{ ac/cfs} * Q_2$   
 $SA_{min} = 0.01 \text{ ac/cfs} * 26 \text{ cfs}$   
 $SA_{min} = 0.26 \text{ ac} = 43560 \text{ sf/ac} * 0.26 \text{ ac} = 11310 \text{ sf}$
9. Check available area at elevation of riser crest  
Available area = 18532 sf (determined by stage/storage relationship)  
Available area  $\geq SA_{min}$  ? Yes X No \_\_\_\_\_
10. Compute required length to achieve 2:1 L:W ratio  
Average width = 80 ft  
Required length = 2 \* average width  
Required length = 2 \* 80 ft  
Required length = 160 ft  
Available length = 170 ft  
2:1 L:W ratio satisfied? Yes X No \_\_\_\_\_  
If no, refer to Figure 6-22.2 for baffle designs. Note any required baffles on E&SC Plan and include calculations and details for baffle(s).

#### Principal Spillway (ps)

11. Determine maximum principal spillway capacity =  $Q_2 = 26$  cfs
12. Compute the vertical distance between the centerline of the outlet pipe and the emergency spillway crest (H)  
 $H = 9.75$  ft
13. Compute the total pipe length of the principal spillway, L, using Figure 6-22.3.  
 $L = [A - (B+C)/2] [Z_u + Z_d] + T + E$   
 $L = 70$  ft



14. Determine diameter of principal spillway ( $D_{ps}$ ) and flow through the principal spillway ( $Q$ ) from Table 6-22.1 using  $H$  and  $Q_2$ .  
 $D_{ps} = 24$  in.  $Q = 33.1$  cfs (value directly from table)
15. Compute actual flow through the principal spillway, using Table 6-22.1 to determine the correction factor for pipe length,  $L$ .  
 $Q_{ps} = Q * \text{correction factor} = 33.1 \text{ cfs} * 1.00$   
 $Q_{ps} = 33.1$  cfs
16. Compute riser diameter ( $D_r$ )  
 $D_r \geq 1.5 * D_{ps}$   
 $D_r \geq 1.5 * 24$  in.  
 $D_r \geq 36$  in.  
 $D_r = 36$  in.
17. Compute trash rack diameter ( $D_t$ )  
 $D_t \geq 1.4 * D_r$   
 $D_t \geq 1.4 * 36$  in.  
 $D_t \geq 50.4$  in.  
 $D_t = 54$  in.
18. Determine the minimum distance between the riser crest and the emergency spillway crest,  $h$ , using Table 6-22.2  $D_r$ , and  $Q_{ps}$ .  
 $h = 1.1$  ft

### Concrete Riser Base Design

19. Determine the volume of concrete per vertical foot of riser height needed (from Table 6-22.3) to prevent flotation.  
 Required volume of concrete per vertical foot = 6.18 cf/v.f.
20. Compute total volume of concrete required.  
 Total required volume of concrete = Required volume per vertical foot \* Riser length  
 Total required volume of concrete = 6.18 cf/v.f. \* 2.5 ft  
 Total volume of concrete required = 15.45 cf
21. Assume base thickness (usually 18") ( $B$ ).  
 $B = 18$  in = 1.5 ft
22. Compute required surface area.  
 Required surface area = Total volume required /  $B$   
 Required surface area = 15.45 cf / 1.5 ft  
 Required surface area = 10.3 sf
23. Compute riser base length ( $l$ ) and width ( $w$ ) (assume square base).  
 $l = w = (\text{required surface area})^{1/2}$   
 $l = w = (10.3 \text{ sf})^{1/2}$   
 $l = w = 3.21$  ft = 12in/ft \* 3.21 ft = 39 in.

### Anti-Seep Collar Design

24. Determine if anti-seep collar is required. If yes to any of the following conditions, a collar is required:  
 \_\_\_\_\_ The settled height of the dam is greater than 15 feet.  
 \_\_\_\_\_ The principal spillway diameter ( $D_{ps}$ ) is smooth pipe larger than 8".  
X The principal spillway diameter ( $D_{ps}$ ) is corrugated metal pipe larger than 12".
25. Determine size of anti-seep collar required.  
X 18-inch projection (for heads ( $H$ ) less than or equal to 10 feet).  
 \_\_\_\_\_ 24-inch projection (for heads ( $H$ ) greater than 10 feet).

### Emergency Spillway ( $es$ )

26. Compute minimum capacity of emergency spillway ( $Q_{es}$ )  
 $Q_{es} = Q_{25} - Q_{ps} = 46$  cfs - 33 cfs  
 $Q_{es} = 13$  cfs
27. Determine stage ( $H_p$ ), bottom width ( $b$ ), velocity ( $V$ ) and minimum exit slope ( $S$ ) using Table 6-22.4 and  $Q_{es}$ .  
 $H_p = 0.7$  ft  $b = 10$  ft  $V = 3.2$  fps  $S = 3.5$  %
28. Actual entrance channel slope,  $S_e = 5$  %
29. Actual exit channel slope,  $S_o = 7$  %  
 Note: If  $S_o$  is steeper than  $S$  (from Table 6-22.4), then the velocity in the exit channel will increase.  
 a.) Calculate exit velocity ( $V_o$ )

$$V_o = V (S_o / S)^{0.3} = 3.8 \text{ fps} * (7 / 35)^{0.3}$$

$$V_o = 4.7 \text{ fps}$$

Note: Refer to Channel Stabilization (Ch) to determine the proper lining for the emergency spillway.

Grass   X   Rip-rap        Concrete       

### Design Elevations

30. Riser crest elevation = 1052.5 ft

31. Compute minimum emergency spillway crest elevation

Minimum emergency spillway crest elevation = Riser crest elevation + h

Minimum emergency spillway crest elevation = 1052.5 ft + 1.1 ft

Minimum emergency spillway crest elevation = 1053.6 ft

Actual emergency spillway crest elevation = 1053.6 ft

32. Determine design high water elevation

Design high water elevation = Emergency spillway crest elevation + Stage elevation (Hp)

Design high water elevation = 1053.6 ft + 0.9 ft

Design high water elevation = 1054.5 ft

33. Determine elevation of top of dam

Elevation of top of dam = Design high water elevation + 1 ft freeboard

Elevation of top of dam = 1054.5 ft + 1 ft

Elevation of top of dam = 1055.5 ft



# TEMPORARY SEDIMENT BASIN DESIGN SHEET

Computed by \_\_\_\_\_ Date \_\_\_\_\_  
Checked by \_\_\_\_\_ Date \_\_\_\_\_

Project Name \_\_\_\_\_  
Basin No. \_\_\_\_\_  
Total area draining to basin = \_\_\_\_\_ acres  
Disturbed area draining to basin = \_\_\_\_\_ acres

## Volume

1. Compute minimum required storage volume ( $V_s$ ).  
 $V_s = 67 \text{ cy/ac} * \text{_____ acres} = \text{_____ cy}$
2. Compute volume of basin at clean-out ( $V_c$ ).  
 $V_c = 22 \text{ cy/ac} * \text{_____ acres} = \text{_____ cy}$
3. Determine elevation corresponding to minimum required storage volume,  $V_s$ .  
Minimum riser crest elevation = \_\_\_\_\_ ft (determined by stage/storage relationship)
4. Determine elevation corresponding to clean-out volume,  $V_c$ .  
Clean-out elevation = \_\_\_\_\_ ft (determined by stage/storage relationship)  
Note: Clean-out elevation shall be clearly marked on the riser or marked by a post near the riser.
5. Compute length of riser.  
Riser length = Minimum elevation of riser crest - Lowest elevation of pipe at riser  
Riser length = \_\_\_\_\_ ft - \_\_\_\_\_ ft  
Riser length = \_\_\_\_\_ ft

## Stormwater Runoff

6. Compute peak discharge from a 2-yr, 24-hr storm event.  
 $Q_2 = \text{_____ cfs}$  (Attach runoff computation sheet.)
7. Compute peak discharge from a 25-yr, 24-hr storm event.  
 $Q_{25} = \text{_____ cfs}$  (Attach runoff computation sheet.)

## Surface Area/Configuration Design

8. Compute minimum basin surface area ( $SA_{min}$ ).  
 $SA_{min} = 0.01 \text{ ac/cfs} * Q_2$   
 $SA_{min} = 0.01 \text{ ac/cfs} * \text{_____ cfs}$   
 $SA_{min} = \text{_____ ac} = 43560 \text{ sf/ac} * \text{_____ ac} = \text{_____ sf}$
9. Check available area at elevation of riser crest.  
Available area = \_\_\_\_\_ sf (determined by stage/storage relationship)  
Available area  $SA_{min}$ ? Yes \_\_\_\_\_ No \_\_\_\_\_
10. Compute required length to achieve 2:1 L:W ratio.  
Average width = \_\_\_\_\_ ft  
Required length = 2 \* average width  
Required length = 2 \* \_\_\_\_\_ ft  
Required length = \_\_\_\_\_ ft  
Available length = \_\_\_\_\_ ft  
2:1 L:W ratio satisfied? Yes \_\_\_\_\_ No \_\_\_\_\_  
If "no", refer to Figure 6-22.2 for baffle designs. Note any required baffles on E&SC Plan and include calculations and details for baffle(s).

## Principal Spillway (ps)

11. Determine maximum principal spillway capacity.  
 $Q_{max} = Q_2 = \text{_____ cfs}$
12. Compute the vertical distance between the centerline of the outlet pipe and the emergency spillway crest (H).  
 $H = \text{_____ ft}$
13. Compute the total pipe length of the principal spillway, L, using Figure 6-22.3.  
 $L = [A - (B+C)/2] [Zu+Zd] + T + E = [ \text{_____} - ( \text{_____} + \text{_____} ) / 2 ] [ \text{_____} + \text{_____} ] + \text{_____} + \text{_____}$   
 $L = \text{_____ ft}$

## TEMPORARY SEDIMENT BASIN DESIGN SHEET

Project Name \_\_\_\_\_

Page 2

14. Determine diameter of principal spillway ( $D_{ps}$ ) and flow through the principal spillway ( $Q$ ) from Table 6-22.1 using  $H$  and  $Q_{max}$ .
- $D_{ps} =$  \_\_\_\_\_ in.       $Q =$  \_\_\_\_\_ cfs (value directly from table)
15. Compute actual flow through the principal spillway, using Table 6-22.1 to determine the correction factor for pipe length,  $L$ .
- $Q_{ps} = Q * \text{correction factor} =$  \_\_\_\_\_ cfs \* \_\_\_\_\_
- $Q_{ps} =$  \_\_\_\_\_ cfs
16. Compute riser diameter ( $D_r$ ).
- $D_r = 1.5 * D_{ps}$
- $D_r = 1.5 *$  \_\_\_\_\_ in.
- $D_r =$  \_\_\_\_\_ in.
- $D_r =$  \_\_\_\_\_ in.
17. Compute trash rack diameter ( $D_t$ ).
- $D_t = 1.4 * D_r$
- $D_t = 1.4 *$  \_\_\_\_\_ in.
- $D_t =$  \_\_\_\_\_ in.
- $D_t =$  \_\_\_\_\_ in.
18. Determine the minimum distance between the riser crest and the emergency spillway crest,  $h$ , using Table 6-22.2
- $D_r$  and  $Q_{ps}$ .
- $h =$  \_\_\_\_\_ ft

### Concrete Riser Base Design

19. Determine the volume of concrete per vertical foot of riser height needed, from Table 6-22.3 to prevent flotation.
- Required volume of concrete per vertical foot = \_\_\_\_\_ cf/v.f.
20. Compute total volume of concrete required.
- Total required volume of concrete = Required volume per vertical foot \* Riser length
- Total required volume of concrete = \_\_\_\_\_ cf/v.f. \* \_\_\_\_\_ ft
- Total volume of concrete required = \_\_\_\_\_ cf
21. Assume base thickness,  $B$  (usually 18").
- $B =$  \_\_\_\_\_ in = \_\_\_\_\_ ft
22. Compute required surface area.
- Required surface area = Total volume required /  $B$
- Required surface area = \_\_\_\_\_ cf / \_\_\_\_\_ ft
- Required surface area = \_\_\_\_\_ sf
23. Compute riser base length ( $l$ ) and width ( $w$ ) (assume square base).
- $l = w = (\text{required surface area})^{1/2}$
- $l = w =$  (\_\_\_\_\_ sf)<sup>1/2</sup>
- $l = w =$  \_\_\_\_\_ ft = 12in/ft \* \_\_\_\_\_ ft = \_\_\_\_\_ in

### Anti-Seep Collar Design

24. Determine if anti-seep collar is required. If yes, to any of the following conditions, a collar is required:
- \_\_\_\_\_ The settled height of the dam is greater than 15 feet.
- \_\_\_\_\_ The principal spillway diameter ( $D_{ps}$ ) is smooth pipe larger than 8".
- \_\_\_\_\_ The principal spillway diameter ( $D_{ps}$ ) is corrugated metal pipe larger than 12".
25. Determine size of anti-seep collar required.
- \_\_\_\_\_ 18-inch projection (for heads ( $H$ ) less than or equal to 10 feet).
- \_\_\_\_\_ 24-inch projection (for heads ( $H$ ) greater than 10 feet).

### Emergency Spillway (es)

26. Compute minimum capacity of emergency spillway ( $Q_{es}$ )
- $Q_{es} = Q_{25} - Q_{ps} =$  \_\_\_\_\_ cfs - \_\_\_\_\_ cfs
- $Q_{es} =$  \_\_\_\_\_ cfs

## TEMPORARY SEDIMENT BASIN DESIGN SHEET

Project Name \_\_\_\_\_

Page 3

27. Determine stage ( $H_p$ ), bottom width ( $b$ ), velocity ( $V$ ) and minimum exit slope ( $S$ ) using Table 6-22.4 and  $Q_{es}$ .

$$H_p = \text{_____ ft} \quad b = \text{_____ ft} \quad V = \text{_____ fps} \quad S = \text{_____ \%}$$

28. Actual entrance channel slope,  $S_e = \text{_____ \%}$

29. Actual exit channel slope,  $S_o = \text{_____ \%}$

Note: If  $S_o$  is steeper than  $S$  (from Table 6-22.4), then the velocity in the exit channel will increase.

a.) Calculate new exit velocity ( $V_o$ )

$$V_o = V (S_o/S)^{0.3} = \text{_____ fps} * (\text{_____} / \text{_____})^{0.3}$$

$$V_o = \text{_____ fps}$$

Note: Refer to Channel Stabilization (Ch) to determine the proper lining for the emergency spillway.

Grass \_\_\_\_\_ Rip-rap \_\_\_\_\_ Concrete \_\_\_\_\_

### Design Elevations

30. Riser crest elevation = \_\_\_\_\_ ft

31. Compute minimum emergency spillway crest elevation.

Minimum emergency spillway crest elevation = Riser crest elevation + h

Minimum emergency spillway crest elevation = \_\_\_\_\_ ft + \_\_\_\_\_ ft

Minimum emergency spillway crest elevation = \_\_\_\_\_ ft

32. Determine design high water elevation

Design high water elevation = Minimum emergency spillway crest elevation + Stage elevation ( $H_p$ )

Design high water elevation = \_\_\_\_\_ ft + \_\_\_\_\_ ft

Design high water elevation = \_\_\_\_\_ ft

33. Determine elevation of top of dam

Elevation of top of dam = Design high water elevation + 1 ft freeboard

Elevation of top of dam = \_\_\_\_\_ ft + 1 ft

Elevation of top of dam = \_\_\_\_\_ ft

**PLEASE NOTE THAT DESIGN VALUES DETERMINED BY THIS SHEET REPRESENT THE MINIMUM REQUIREMENTS FOR A TEMPORARY SEDIMENT BASIN.**



# TEMPORARY SEDIMENT BASIN

## CROSS-SECTIONAL DETAIL

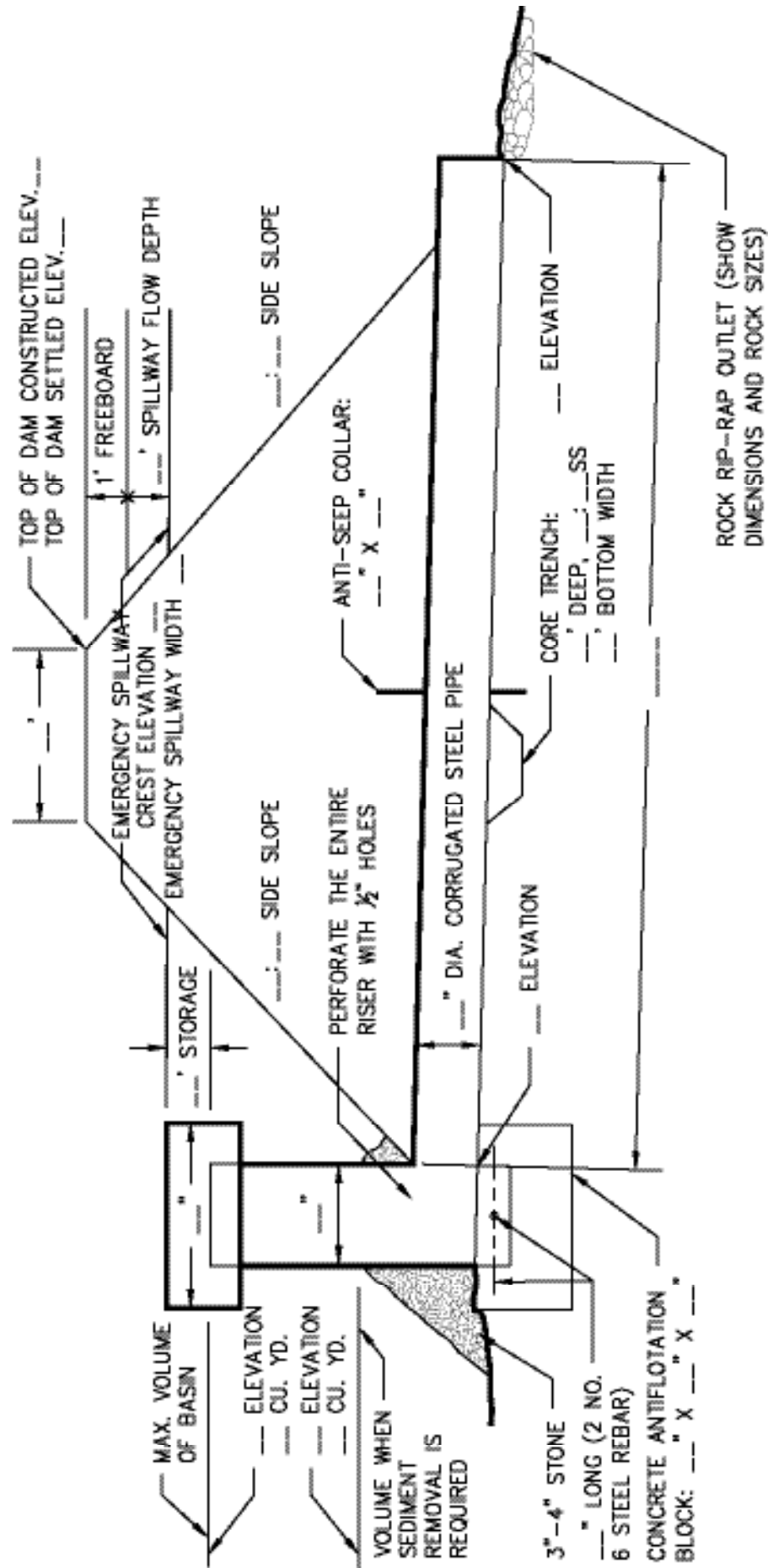
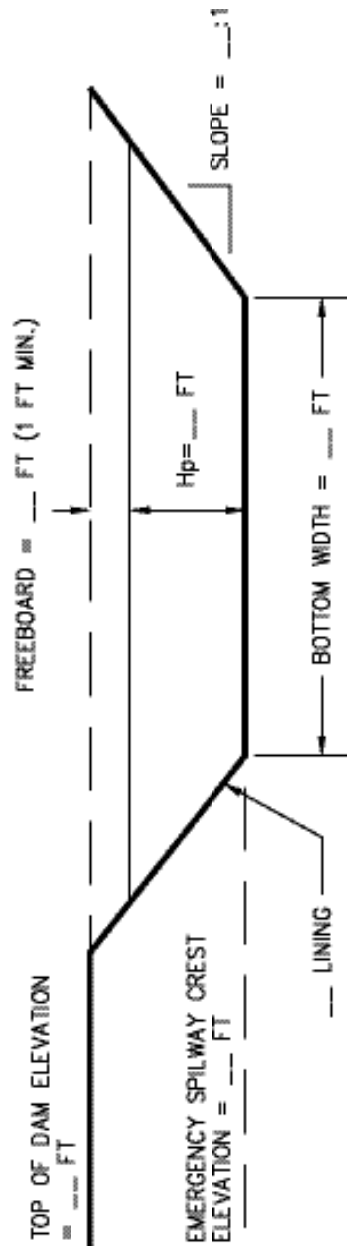

Figure 6-29.7



# CROSS-SECTIONAL DETAIL OF EMERGENCY SPILLWAY

## PROFILE ALONG CENTERLINE



## EMERGENCY SPILLWAY

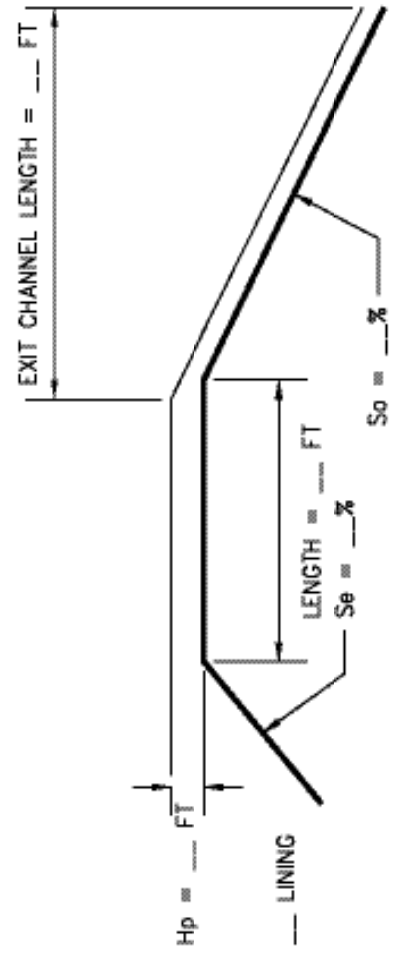

Figure 6-29.8

# Temporary Sediment Trap

Sd4



## DEFINITION

A small temporary pond that drains a disturbed area so that sediment can settle out. The principle feature distinguishing a temporary sediment trap from a temporary sediment basin is the lack of a pipe or riser.

## PURPOSE

To collect and store sediment from uphill sites cleared and or graded during construction. Intended for use on small tributary areas with no unusual drainage features. Effective against coarse sediment, but not against silt or clay particles that remain suspended.

## CONDITIONS

Temporary sediment traps are constructed early in the construction process at locations that will require minimal clearing and grading. Natural draws or swells are favorable locations to build the traps. They should be easily accessible for frequent maintenance and inspections. Temporary sediment traps shall never be placed in live streams.

## DESIGN CRITERIA

Design and construction shall comply with laws, ordinances, rules and regulations on the local, state and federal level.

The total drainage area of a temporary sediment trap is up to 5 acres, depending on type of construction.

The height of a temporary sediment trap embankment shall not exceed 5.5 feet as measured from the downstream toe of slope to the top of the berm. Top width of an embankment shall be

at least as wide as the height of the sediment trap embankment, with a minimum width of 3 feet.

Maximum pond depth of a sediment trap is 4 feet as measured from the bottom of the trap to the invert of the emergency spillway. Slopes shall not exceed 2:1 (H:V) for excavated areas and for compacted embankments. Side slopes should be (3:1) or flatter allowing people and equipment to safely negotiate slopes or to enter the sediment trap.

The length to width ratio must be greater than (2:1) (L:W) for the principal flowpaths in order to maximize residence time of stormwater within the sediment trap. Baffles may be required to prevent short-circuiting of the flow.

A typical baffle design uses 4'x8' sheets of exterior grade plywood 1/2 inch thick, mounted on 4"x4" hardwood posts.

## Volume

Minimum volume of a temporary sediment trap shall be 67 cubic yards per acre for the total drainage area. The volume shall be measured at an elevation equivalent to the spillway invert.

Volume of a temporary sediment trap in heavily disturbed areas should be 134 cubic yards per acre for the total drainage area. This includes an upper area with a minimum of 67 cubic yards per acre drained, which is dewatered using one of the outlet design methods provided, and a lower wet zone for sediment storage and settling.

The volume should be calculated from existing and proposed contours, or by measured cross sections. An approximate method for calculating the volume of traps using a natural draw is:

$$V = 0.4 \times A \times D$$

V = Sediment storage volume (below invert of emergency spillway)

A = Surface area (at level of emergency spillway)

D = Maximum depth (from emergency spillway invert)

The cleanout volume for a temporary sediment trap is 1/3 of the total storage volume. Cleanout volume shall be calculated and marked with a stake at the outlet of the trap.

## **CONSTRUCTION SPECIFICATIONS**

The basic design guidelines are applicable to the type of temporary sediment trap constructed. The main differences are with regards to the type of outlet structures. The following types of construction are acceptable under the designated conditions:

### **Overflow (Sd4-A)**

An overflow temporary sediment trap is limited to small areas less than 1 acre, typically with gentle slopes (1 or 2 percent) and without major grading operations. The maximum life span of an overflow trap is 6 months. If water enters the trap with very low velocities, the same amount of water will be slowly displaced and leave the other end of the sediment trap. Silt fence, straw bale barriers or grass filter strips are used to “polish” the overflow water as it leaves the sediment trap. See Figure 6-30.1

### **Combination Straw Bale and Silt Fence Outlet (Sd4-B)**

The combination outlet uses straw bales and silt fence to dewater the sediment trap. Proper installation and staking of the straw bales, and wire backing on the silt fence are required for the materials to resist 1 foot or more of ponded water. The combination straw bale and silt fence outlet is limited to 1 acre total drainage area, and has a life span of less than 1 year. This type of outlet requires frequent maintenance and adjustments to ensure the released stormwater is free from sediment. See Figure 6-30.2

### **Rock Outlet (Sd4-C)**

The rock outlet relies on filtering through layers of aggregate, rock or riprap material to dewater the sediment trap. It is the sturdiest of the sediment trap designs and generally requires less maintenance. It can be used for drainage area up to 5 acres and has a life span of 1 year. See Figure 6-30.3

### **Emergency Spillway**

The emergency overflow outlet of a temporary sediment trap must be stabilized with rock, geotextile, vegetation, or another suitable material that is resistant to erosion. It must be installed to safely convey stormwater runoff for the 10-year storm event.

## **REFERENCE:**

City of Knoxville BMP Manual Best Management Practices, Knoxville, TN, May 2003

# TEMPORARY SEDIMENT TRAP

COURTESY OF CITY OF KNOXVILLE BMP EROSION AND SEDIMENT

## OVERFLOW

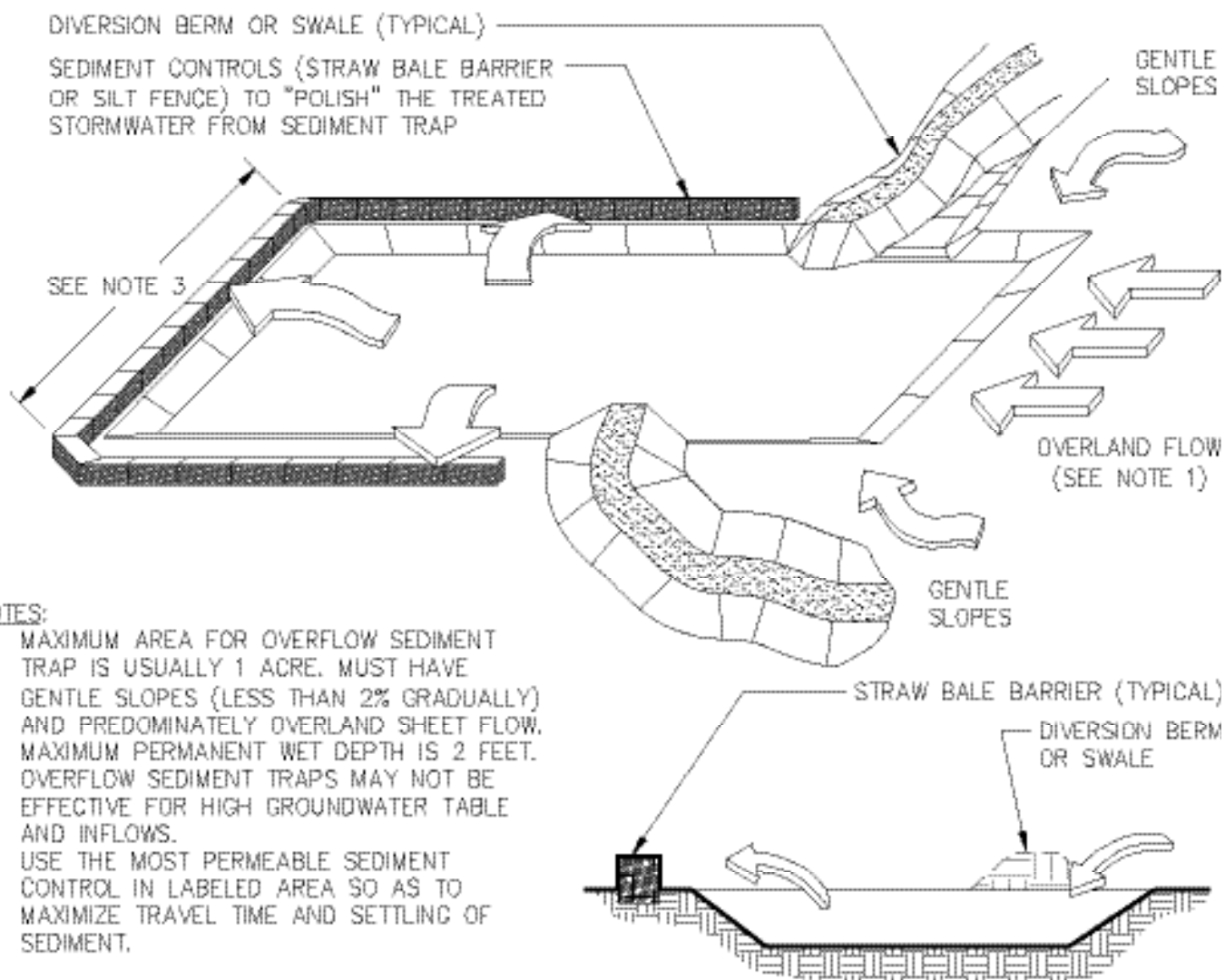

### NOTES:

1. MAXIMUM AREA FOR OVERFLOW SEDIMENT TRAP IS USUALLY 1 ACRE. MUST HAVE GENTLE SLOPES (LESS THAN 2% GRADUALLY) AND PREDOMINATELY OVERLAND SHEET FLOW.
2. MAXIMUM PERMANENT WET DEPTH IS 2 FEET. OVERFLOW SEDIMENT TRAPS MAY NOT BE EFFECTIVE FOR HIGH GROUNDWATER TABLE AND INFLOWS.
3. USE THE MOST PERMEABLE SEDIMENT CONTROL IN LABELED AREA SO AS TO MAXIMIZE TRAVEL TIME AND SETTLING OF SEDIMENT.

Figure 6-30.1

# TEMPORARY SEDIMENT TRAP

COURTESY OF CITY OF KNOXVILLE BMP EROSION AND SEDIMENT

## COMBINATION OUTLET

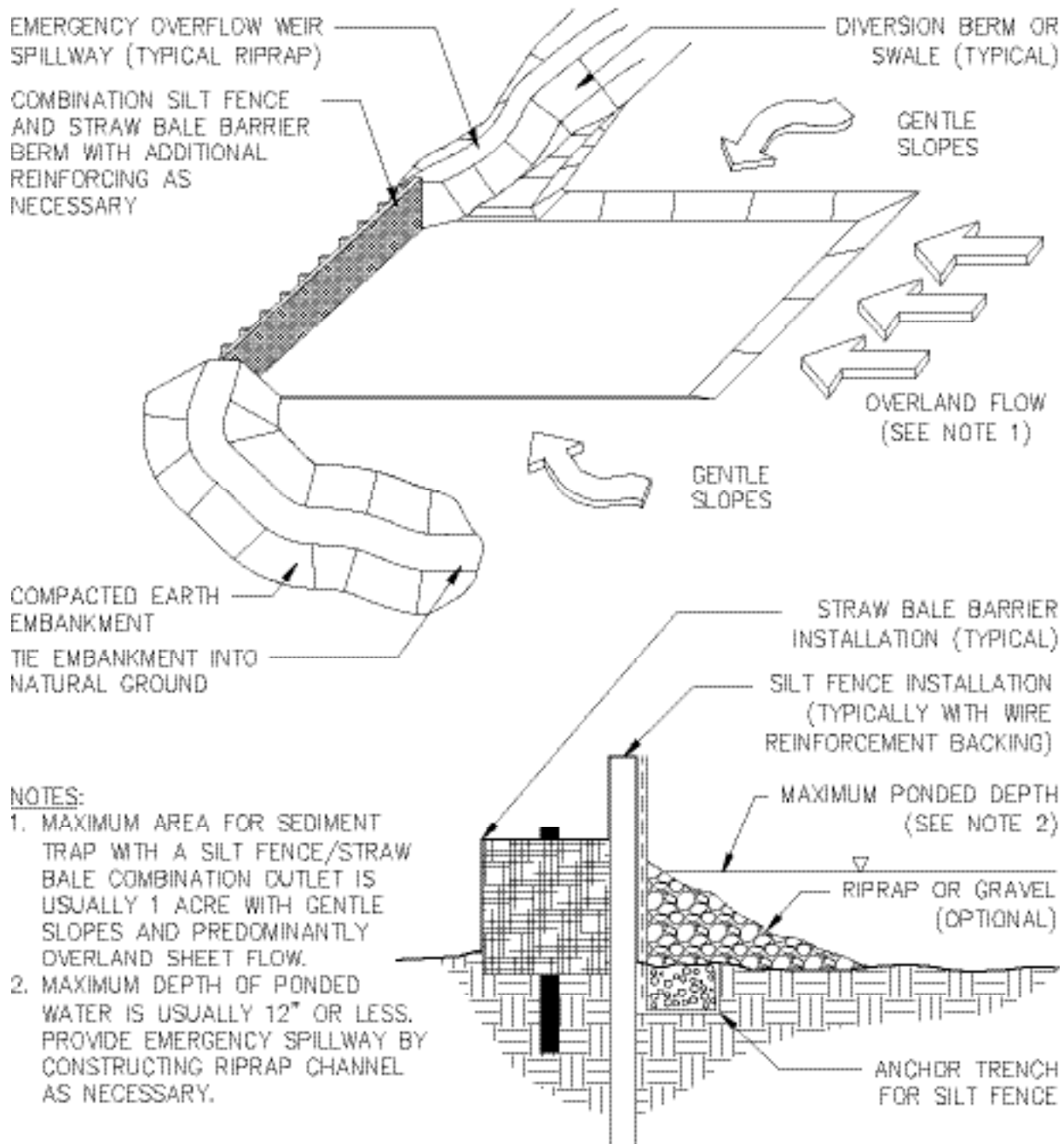

Figure 6-30.2

# TEMPORARY SEDIMENT TRAP

COURTESY OF CITY OF KNOXVILLE BMP EROSION AND SEDIMENT  
**ROCK OUTLET**

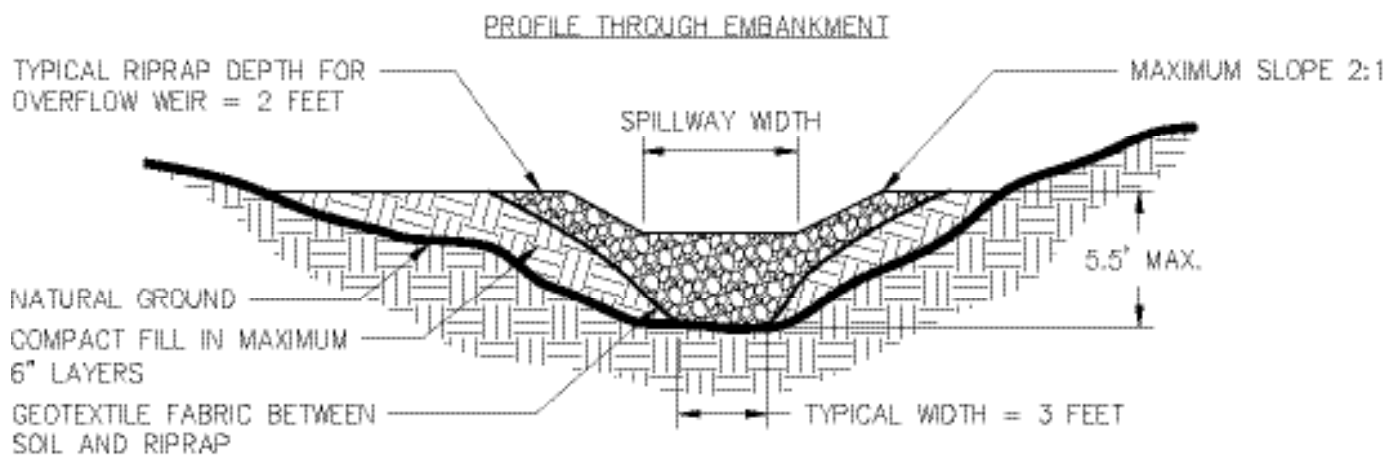
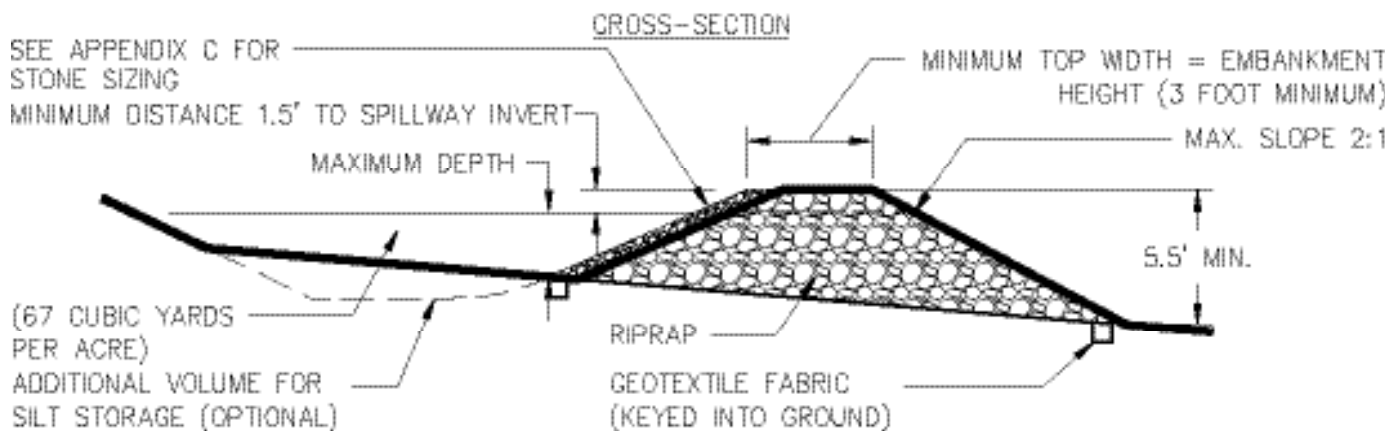
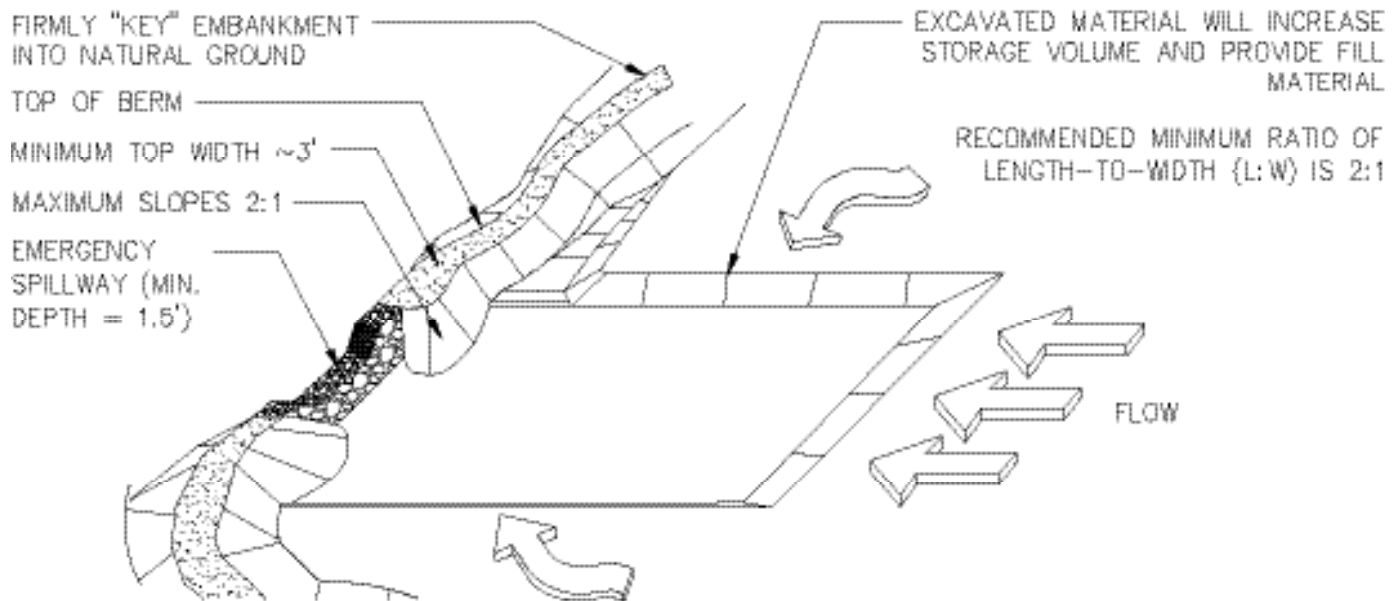

Figure 6-30.3



# Floating Surface Skimmer

Sk



## DEFINITION

A floating surface skimmer is a buoyant device that releases/drains water from the surface of sediment ponds, traps or basins at a controlled rate of flow. It “skims”, or dewater, from the water surface where sediment concentrations are at a minimum in the water column instead of draining from the bottom where sediment concentrations are their highest, and drains to a riser or the backside of a dam.

Floating surface skimmers release a low rate of flow, draining the basin slowly at a nearly constant rate. The inlet of the skimmer device is sized according to the basin volume and designed to drain the basin in a fixed amount of time. Traditional sediment basin outlet designs use a perforated riser for dewatering, which allows water to leave the basin from all depths.

## PURPOSE

- To discharge clearer water from the surface of a sediment pond, trap or basin at a relatively uniform rate, rather than the more turbid and sediment-laden water from lower depths that is discharged through a traditional perforated riser.
- To reduce the retention time associated with meeting a desired water quality standard for discharge from a sediment pond, trap or basin.

## CONDITIONS

The current principal spillway of most sediment basins is a vertical riser pipe. Water discharges through 1/2 inch perforated holes in the

bottom half of the riser. Holes at lower elevations discharge water that has a high turbidity value. The bottom half of the riser is typically covered with 2 feet of ½- to ¾-inch gravel. Over time, the gravel filter surrounding the riser is coated with sediment that traps and detains water in the basin. This reduces the storage capacity for incoming runoff. Sediment in the trapped water is re-suspended with each new inflow, and never has the opportunity to settle to the bottom.

## DESIGN CRITERIA

A surface skimmer (Sk) replaces the riser pipe as the principal spillway, but **DOES NOT REPLACE THE EMERGENCY OVERFLOW SPILLWAY**. The skimmer only drains the basin from the crest of the emergency overflow spillway down to the bottom. Its flow capacity is too small to accommodate extreme storm events that exceed the available storage capacity, so an emergency spillway is required.

When rainfall events occur, the water level in the basin rises. Under the influence of gravity, sediment settles slowly toward the bottom, leaving clearer water at the surface. The skimmer floats at the surface as the water surface rises and discharges the cleaner water at a relatively uniform rate. By draining from the surface a skimmer can immediately begin removing relatively clear water from the pond, trap or basin, and thereby reduce the retention time to obtain similarly clear discharge using traditional outlets.

## Product Designs

One end of a rigid tube is connected to the barrel of the discharge system via a flexible coupling. The other end of the tube floats at the water surface. The flexible coupling allows the rigid tube to articulate as the water level changes. A screen at the inlet prevents floating trash from entering the tube. Each product (and each product size) has a unique design, including the associated hydraulics that are affected by the floatation, inlet, and connecting tube/coupling designs chosen. The discharge rate is dependent on the specific product design and can only be determined through product-specific testing as discussed in Addendum A.

## Dewatering Rates.

Skimmers come in several sizes to accommo-





**Figure 6-31.1. Floating skimmer of a different design.**

date a range of flows. The plans shall indicate a volume to be drained in a specified time period. A skimmer is then selected to satisfy this requirement. Addendum B presents a typical skimmer selection table based on product-specific testing in accordance with Addendum A.

### **Floation Requirements**

Floating surface skimmers that sink or completely suspend under the water surface are not acceptable. A portion of the skimmer must be visible above the water surface at all times. The location of the floating “headworks” relative to the water surface, and the size and location of vents and inlets, must be the same as when the product was tested for flow rates. This should be verified and documented as inherent to the product design during flow testing.

### **Trash Guard & Maintenance Rope**

All Floating surface skimmer designs include a trash guard and maintenance rope in order to prevent and remove blockage from floating debris. Trash guards prevent larger debris from entering the skimmer that may cause internal blockage. The maintenance rope is used to remove trash and debris that accumulates on the outside of the trash guard. Ensure the maintenance rope is floatable.

### **Skimmer Pit**

Excavate a shallow pit filled with riprap under the floating surface skimmer to account for sediment that accumulates on the sediment basin bottom around the skimmer. The pit allows the skimmer to completely drain the basin. At a minimum, the pit has dimensions of 4ft x 4ft with a minimum depth of 2 ft. Ensure the bottom of

the pit is lower than the invert of the outlet barrel from the riser. Floating Skimmers that have a footed design that prevents the device from lodging in accumulated sediment do not require a skimmer pit.

## **CONSTRUCTION SPECIFICATIONS**

### **Materials**

Use floating surface skimmers made of PVC (Schedule 40 or greater) or other appropriate materials.

### **Quality Assurance**

Each skimmer must have documented identification, including but not limited to the following:

- Manufacturer’s name and location.
- Manufacturer’s telephone number and fax number.
- Manufacturer’s e-mail and web address.
- Skimmer name, model, and/or serial number.
- Skimmer dimensions.
- Certification that the skimmer meets the physical and performance criteria of this specification.

### **Installation**

Install the device according to the manufacturer’s instructions.

### **Additional Information**

A shut-off valve to facilitate skimmer maintenance or emergency regulation of the flow discharge rate, installed at the discharge end of the barrel as it exits the embankment is recommended. (Normal skimmer operation is to be based on the “full open” valve setting.) A storm drain outlet protection device shall be installed at the barrel discharge point.

## **MAINTENANCE**

**Inspect Floating Skimmers together with the Sediment Basin inspections.** Inspect the floating surface skimmer for any structural damage, clogging, or excessive sediment accumulation.

While draining the basin, the trash guard of the skimmer may clog with debris. Typically, a

few jerks on the maintenance rope will clear the skimmer of debris and restore flow. If jerking the maintenance rope does not work, pull the skimmer to the embankment with the maintenance rope and manually remove all debris from the trash guard. An internal clog or blockage may require the device to be disassembled and repaired.

If the skimmer becomes stuck in the mud at the bottom of the basin it must be freed to allow for normal operation. This can typically be done by use of the maintenance rope.

Remove sediment deposits from the basin when approximately one-third of the storage volume has been lost to sediment accumulation or when the floating skimmer cannot settle low enough to drain the entire basin. Remove or pull the skimmer to a side embankment using the maintenance rope and remove sediment from the skimmer pit.

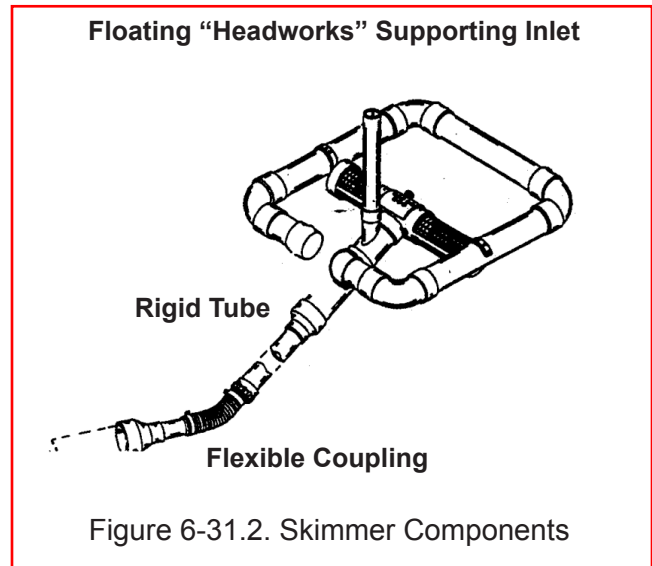

Figure 6-31.2. Skimmer Components

**TO BE SHOWN ON THE EROSION, SEDIMENTATION AND POLLUTION CONTROL PLAN**

When a FLOATING SURFACE SKIMMER is used, show the following information along with each sediment pond, trap or basin being used on the site:

1. Pond, trap or basin size, length\* (top and bottom) width\* (top and bottom) and depth = \_\_\_\_\_
2. Time to Drain (hrs) = \_\_\_\_\_
3. Skimmer Dimensions (orifice and head size)\*\* \_\_\_\_\_
4. Manufacturer's name \_\_\_\_\_

\*feet, \*\* inches

**Addendum A: Procedure for Measurement of Floating Pond Skimmer Flow Rate**

This procedure is for evaluating the flow rate of a floating pond skimmer vs. pond depth, including details for setting up a performance test that can be used for design characterization as well as quality assurance to determine product conformance to project specifications.

**Procedure**

**a. Apparatus/Facility**

- i. Testing is performed in a calibrated basin

(i.e. it has a known surface area at any known depth.)

- ii. The basin shall be at least 40-ft long x 6-ft wide x 4-ft deep.
- iii. The basin shall be outfitted with discharge pipe having a diameter no smaller than that of the pipe joining to the floating skimmer head. The discharge pipe shall have a valve that can be controlled from the outside of the basin to initiate

and stop flow through the skimmer. It is also recommended to have a second valved discharge pipe to enable lowering of the water surface within the basin if desired to take flow rate measurements at various depths without waiting for drainage exclusively through the skimmer.

- iv. A water supply along with an associated pump and piping is needed to fill the calibrated basin. A calibrated ruler shall be mounted on the side of the basin to allow depth to be read. This calibrated ruler must not be moved, repositioned, jarred, or tampered with once the first reading of each replicate has been taken.

#### **b. Test Set-Up**

- i. The test basin shall be watertight with at least one discharge pipe at least as large as the pipe that connects to the floating skimmer head. The discharge pipe shall have an accessible valve to control flow.
- ii. The skimmer is attached to the discharge pipe prior to pond filling using reducers/connectors as directed by the client. The connection must be watertight so that all drainage is through the floating skimmer headworks/inlet.

#### **c. Test Operation and Data Collection:**

- i. With the valve on the discharge pipe closed, and the skimmer to be tested in place, fill the test basin with water to the maximum desired depth. Filling should proceed slowly enough to allow all air within the skimmer assembly to bleed completely during filling.
- ii. Once the basin is filled to the desired depth, allow the water surface to become still and record the depth on the ruler mounted to the sidewall.
- iii. Simultaneously open the discharge pipe valve and start timing.
- iv. As the water is discharged from the test basin through the floating skimmer, periodically record depth and associated time.

#### **d. Test Data:**

- i. Record and tabulate water surface elevation as a function of time.
- ii. From the change in surface elevation with time, compute the flow rate and report it at the average of the associated elevations.

#### **Addendum B: Selecting a Skimmer**

It is a straight forward process to choose the skimmer that best matches the required “time-to-drain” specified for a project. The volume (or dimensions) of the sediment pond, trap, or basin must be known, as well as, the number of days to drain the basin. With this information, a draw-down rate calculation is made for each product and sized using the product-specific flow rates determined in accordance with Addendum A.

Figure 6-31.3, shows a typical spreadsheet set up to make this calculation. This spreadsheet lets the user input the pond dimensions and depth, as well as the time-to-drain requirement, and then calculates the time in hours that it would take for each skimmer size (and orifice size) to completely drain the pond.

As different style skimmers are made from a wide variety of parts, including different diameter pipe components in the same device, it is generally agreed that the skimmer size is defined by the “rigid tube” diameter connecting the floating/intake components to the (larger) flexible coupling and outlet pipe.



**NOTE:**  
 SKIMMER CONFIGURATION SHOWN IS  
 TYPICAL. THE DESIGNER/ENGINEER  
 MAY SUBMIT AN ALTERNATE SKIMMER  
 DETAIL FOR REVIEW.

**SKIMMER PERSPECTIVE**

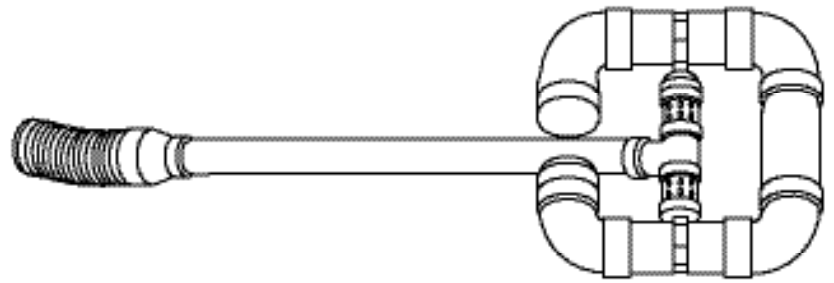

**SKIMMER FRONTAL SECTION VIEW**

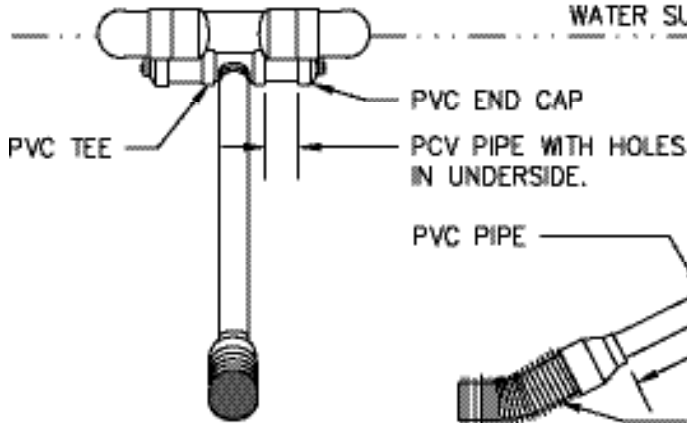

**SKIMMER SIDE SECTION VIEW**

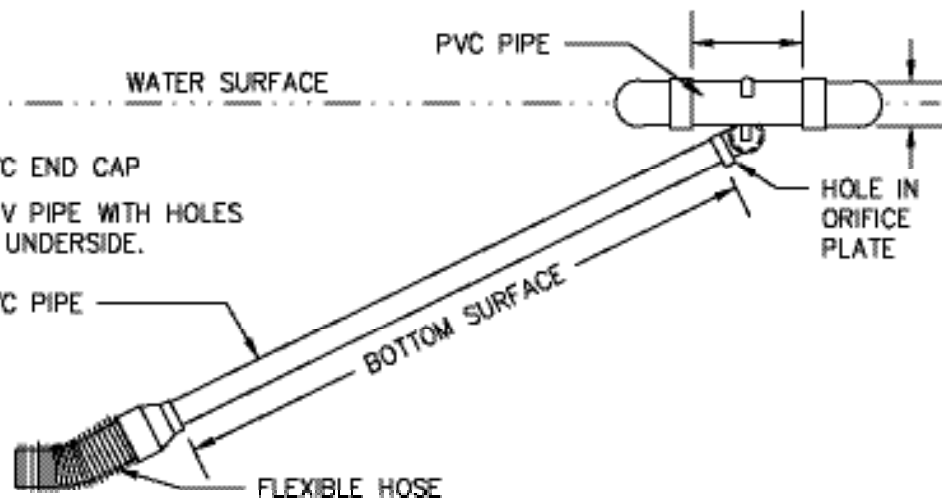

Figure 6-31.4

# Seep Berm

SpB



## DEFINITION

A seep berm is a linear control device constructed as a diversion perpendicular to the direction of the runoff to enhance dissipation and infiltration of runoff, while creating multiple sedimentation chambers with the employment of intermediate dikes.

## PURPOSE

To allow the 2 year storm event, 24 hour design storm to seep out while allowing larger flows to be diverted to a sediment storage area.

## CONDITIONS

Seep berms should be installed where runoff can be stored behind the seep berm without damaging the berm or submerged area behind the intermediate dike points. Seep berms are usually employed down-gradient of construction sites near the boundary of development.

This standard applies under the following conditions:

1. Seep berms shall not be used above fill slopes that have not achieved permanent stabilization meeting the definition of final stabilization.
2. Seep berms shall be designed by the design professional for use on a site.

Seep berms shall not be installed across streams, ditches, waterways, or other concentrated flow areas.

## DESIGN CRITERIA

The seep berm shall have a minimum width of 12 inches across the top of berm and shall not

be taller than 4 feet in height. The top of berm may vary or stay constant. The storage area should be identified (shaded) on the plans.

Two or more intermediate dikes in a series shall be used for drainage areas greater than one acre. Maximum spacing between dikes should be such that the toe of the upstream dike is at the same elevation as the top of the downstream dike. Intermediate dikes shall pass the 25-year storm event.

If a fill berm is utilized it is very important that it has proper compaction and receives the proper stabilization. Fill berms should be stabilized with a slope stabilization meeting the c-factor. Stabilization and applying seed at 70% germination or better shall occur prior to other land disturbing activities taking place in the drainage basin.

Berm storage volumes can be figured as a function of berm height and watershed gradient. The volumes shall be calculated using 67 cubic yards per acre drained to the berm. Detailed calculations shall be shown on the plans when using the seep berms for sediment storage. If a berm encounters different gradients then it should be calculated using the steepest slope in that run, existing or proposed. Clean out markers must be placed at each intermediate dike using a sediment storage calculation.

When the berms remain in place they may be utilized as a walking trail, etc.

## CONSTRUCTION SPECIFICATIONS

Seep berms are readily constructed using typical on-site construction equipment. The earthen berm shall be compacted. This can be easily done through tracking by a skid-loader with a full bucket, tracking with a dozer and applying pressure with the bucket of a track hoe or rubber tired backhoe (min. 90% std. protor test).

Three general options are applicable for seep placement.

1. Seeps can be placed during the construction of the berm, but then care must be exerted when compacting above the seeps.
2. After the entire berm has been constructed, excavation at the location of the seeps can

be conducted, seeps placed in the trench and back-filled, and the berm compacted above the seeps.

3. Completely build the earthen berm with proper compaction and then using a steel pipe with a conical end insert pipes through the berm.

## **MAINTENANCE**

Inspect the drain from the seep and supporting berm after every half inch rainfall event or greater, or weekly depending on environmental conditions. Promptly make necessary repairs. The seep berms shall have the sediment removed when sediment accumulates to one-third the height of the intermediate dike or before.

## SEEP BERM PLAN AND CROSS-SECTION

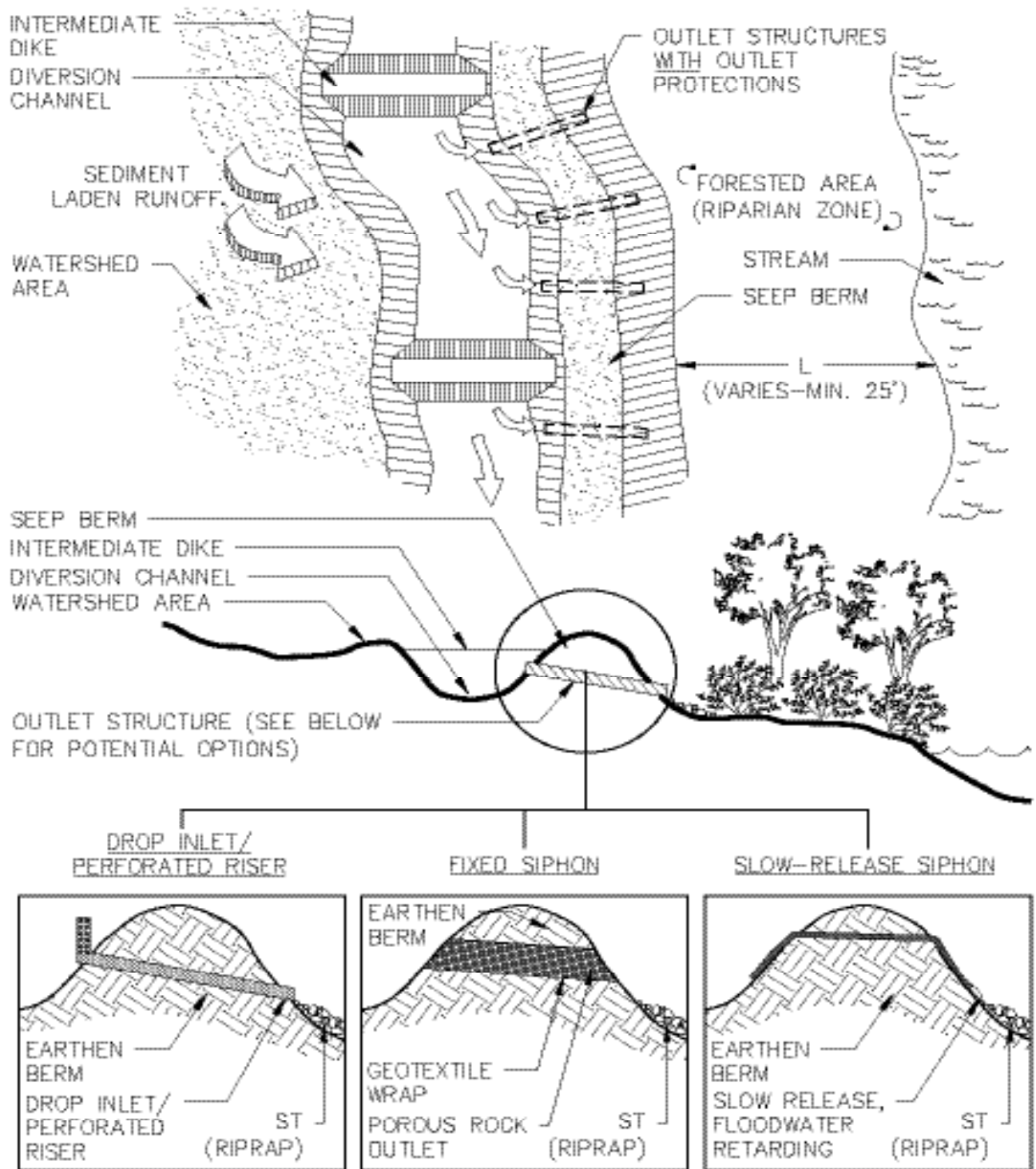

\*DESIGNER/ENGINEER MUST DEFINE IF SEEP BERM IS TO BE A TEMPORARY OR PERMANENT BMP.

**Figure 6-32.1 Integrated Seep Berm Erosion Control System**



## References

Dirt II Technical Panel Completion Report, Repairing the Chattahoochee. (2001).  
Chattahoochee-Flint Regional Development Center, Franklin, GA.  
[http://www.gaepd.org/Documents/techguide\\_wpb.html#es](http://www.gaepd.org/Documents/techguide_wpb.html#es)

Strun, T.W., Warner, R.C., Torrealba,S., and Hamade,F. (2008).  
Demonstration of a Performanced-Based System of Storm Water and Erosion Controls on Small Residen-  
tial/Commercial Sites in the Georgia Piedmont.  
Final Report submitted to Georgia EPD, Project751-40101.

Warner,R., Schwab,P.J., and Marshall, D.J. (1998). SEDCAD 4 Design Manual and User's Guide. Civil  
Software Design.

Breedlove,M.W., Breedlove Land Planning Inc. Seep Berm Installation. Personal Interview April, 2013.

Warner,R.C., Strun,T.W., Torrealba,S. (2007). Seep Berm Design Manual.  
Final Report submitted to Georgia EPD and U.S. Environmental Protection Agency, Atlanta, GA

### TO BE SHOWN ON THE EROSION, SEDIMENTATION AND POLLUTION CONTROL PLAN

- A. Top of Berm Elevation \_\_\_\_\_ ft
- B. Bottom of Berm Elevation \_\_\_\_\_ ft
- C. Top of Berm Width \_\_\_\_\_ ft
- D. Height of the Berm \_\_\_\_\_ ft
- E. Seep Hole Diameter \_\_\_\_\_ ft
- F. Distance from the the Top of the Seep to be Placed in Accordance with the 2yr-24hr storm  
\_\_\_\_\_ ft
- G. Type of Seep (circle one)
- PVC          Metal          Other(specify) \_\_\_\_\_
- H. Spacing of Seep Along the Berm \_\_\_\_\_ ft

# Temporary Stream Crossing

Sr



## DEFINITION

A *temporary* structure installed across a flowing stream or watercourse for use by construction equipment.

## PURPOSE

This standard provides a means for construction vehicles to cross streams or watercourses without moving sediment into streams, damaging the streambed or channel, or causing flooding.

## CONDITIONS

Temporary stream crossings should not be used on streams with drainage areas greater than one square mile, unless specifically designed to accommodate the additional drainage area by the design professional. A certification statement and signature shall accompany the design.

Structures may include bridges, round pipes or pipe arches.

Temporary stream crossings should be in place for less than one year and should not be used by the general public.

## DESIGN CRITERIA

### Size

The structure shall be large enough to convey the full bank flow of the stream, typically flows produced by a 2-year, 24-hour frequency storm, without appreciably altering the stream flow characteristic.

## Location

The temporary stream crossing shall be perpendicular to the stream. Where approach conditions dictate, the crossing may vary 15% from the perpendicular.

## Overflow Protection

Structures shall be protected from washout during periods of peak discharges by diverting water around the structures. Methods to be considered for washout protection may include elevation of bridges above adjacent flood plain lands, crowning of fills over pipes, or by the use of diversions, dikes or island type structures. Two types of stream crossings that may be used are bridges and culverts. Frequency and intended use, stream channel conditions, overflow areas, potential flood damage, and surface runoff control should be considered when selecting the type of temporary stream crossing to be used.

## Temporary Bridge Crossing

Sr-B

A temporary access bridge causes the least erosion of the stream channel crossing when the bridge is installed and removed. It also provides the least obstruction to flow and fish migration. Provided that the bridge is properly designed and appropriate materials are used, a temporary access bridge will be long-lasting and will require little maintenance. However, it is generally the most expensive crossing to design and construct, creating the greatest safety hazard if not adequately designed, installed and maintained.

## Temporary Culvert Crossing

Sr-C

A temporary access culvert can control erosion effectively, but can cause erosion when it is installed and removed. It is the most common stream crossing. A temporary culvert can be easily constructed and enables heavy equipment loads to be used. However, culverts create the greatest obstruction to flood flows and are subject to blockage and washout.

Table 6-33.1 shall be used to determine the culvert size necessary to safely convey streamflow.

**Table 6-33.1. Corrugated Metal Pipe (CMP) Diameters For Temporary Stream Crossings <sup>a</sup>**

Drainage Area (Acres)	Average Slope of Watershed			
	1%	4%	8%	16%
1-25	24	24	30	30
26-50	24	30	36	36
51-100	30	36	42	48
101-150	30	42	48	48
151-200	36	42	48	54
201-250	36	48	54	54
251-300	36	48	54	60
301-350	42	48	60	60
351-400	42	54	60	60
401-450	42	54	60	72
451-500	42	54	60	72
501-550	48	60	60	72
551-600	48	60	60	72
601-640	48	60	72	72

<sup>a</sup> Assumptions for determining the table: USDA-NRCS Peak Discharge Method; CN = 65; Rainfall depth (average for Georgia) = 3.7" for 2-year frequency. Pipe diameters shown in the table are in inches.

*Please note that the required pipe size is based on cross-sectional area of the pipe; e.g. if a 24 inch pipe is prescribed by Table 33.1, two 12 inch pipes could not be substituted because less flow area is provided.*

## CONSTRUCTION SPECIFICATIONS

### All Crossings

1. Clearing of the stream bed and banks shall be kept to a minimum.
2. All surface water from the construction site shall be diverted onto undisturbed areas adjoining the stream. Line unstable stream banks with riprap or otherwise appropriately stabilize them.
3. The structure shall be removed as soon as it is no longer necessary for project construction.
4. Upon removal of the structure, the stream shall immediately be restored to its original cross-section and properly stabilized.

### Temporary Bridge Crossing

Sr-B

1. The temporary bridge shall be constructed at or above bank elevation to prevent the entrapment of floating materials and debris.
2. Abutments shall be placed parallel to and on stable banks.
3. Bridges shall be constructed to span the entire channel. If the channel width exceeds eight feet (as measured from the tops of the banks), a footing, pier or bridge support may be constructed within the waterway.
4. Bridges shall be securely anchored at only one end using steel cable or chain. This will prevent channel obstruction in the event that floodwaters float the bridge. Large trees, large boulders, or driven steel anchors can serve as anchors.

### Temporary Culvert Crossing

Sr-C

1. The invert elevation of the culvert shall be installed on the natural streambed grade.
2. The culvert(s) shall extend a minimum of one foot beyond the upstream and downstream toe of the aggregate placed around the culvert. In no case shall the culvert exceed 40 feet in length.
3. The culvert(s) shall be covered with a minimum of one foot of aggregate. If multiple culverts are used, they shall be separated by a minimum of 12 inches of compacted aggregate fill.

## MAINTENANCE

The structure shall be inspected after every rainfall and at least once a week, whether it has rained or not, and all damages repaired immediately. The structure shall be removed immediately after construction is finished, and the streambed and banks must be stabilized. Refer to specification **Bf - Buffer Zone**.

TO BE SHOWN ON THE EROSION AND SEDIMENT CONTROL PLAN

1. Drainage area (ac), average slope of watershed (%), and stream flow rate at bankfull flow (cfs).
2. Detailed dimensions of components for the type of crossing to be used.

# TEMPORARY BRIDGE CROSSING

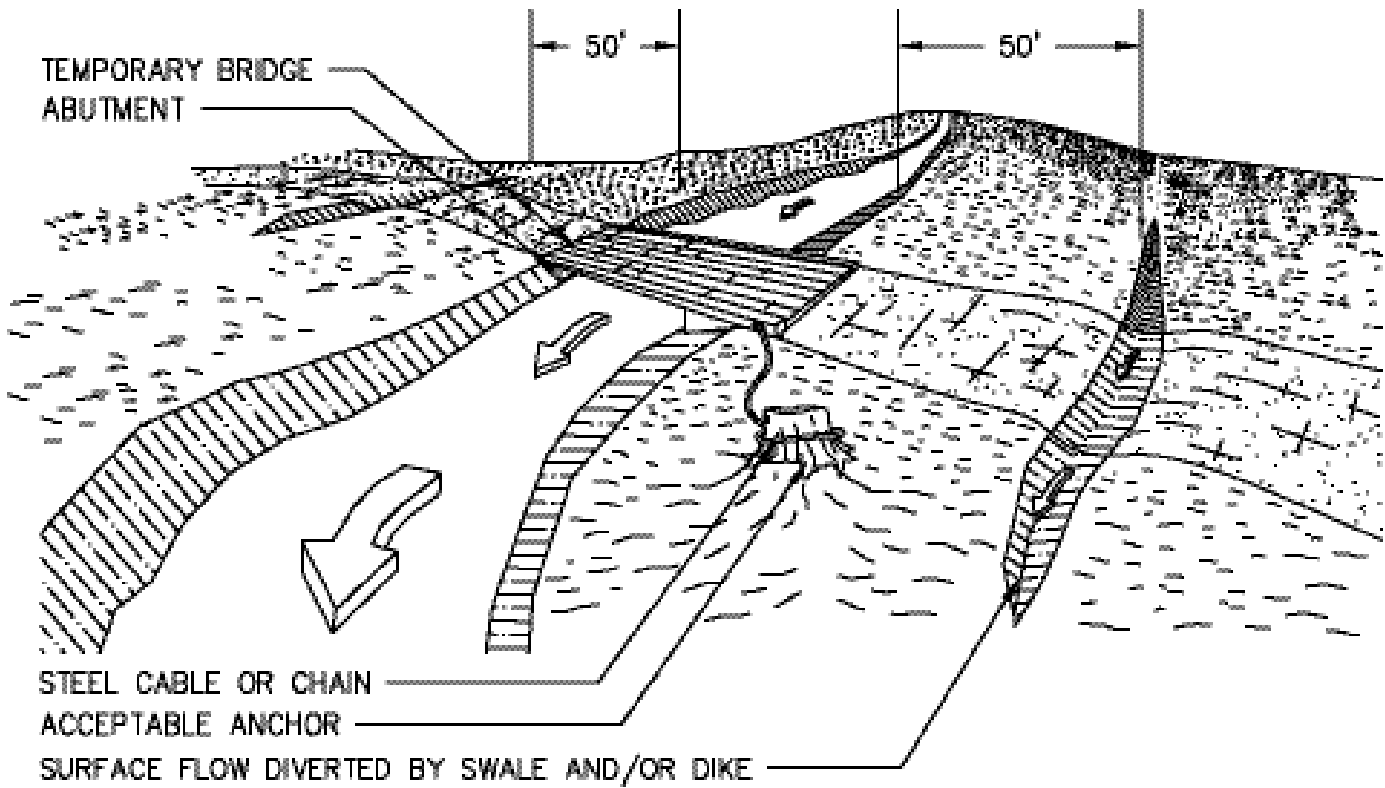
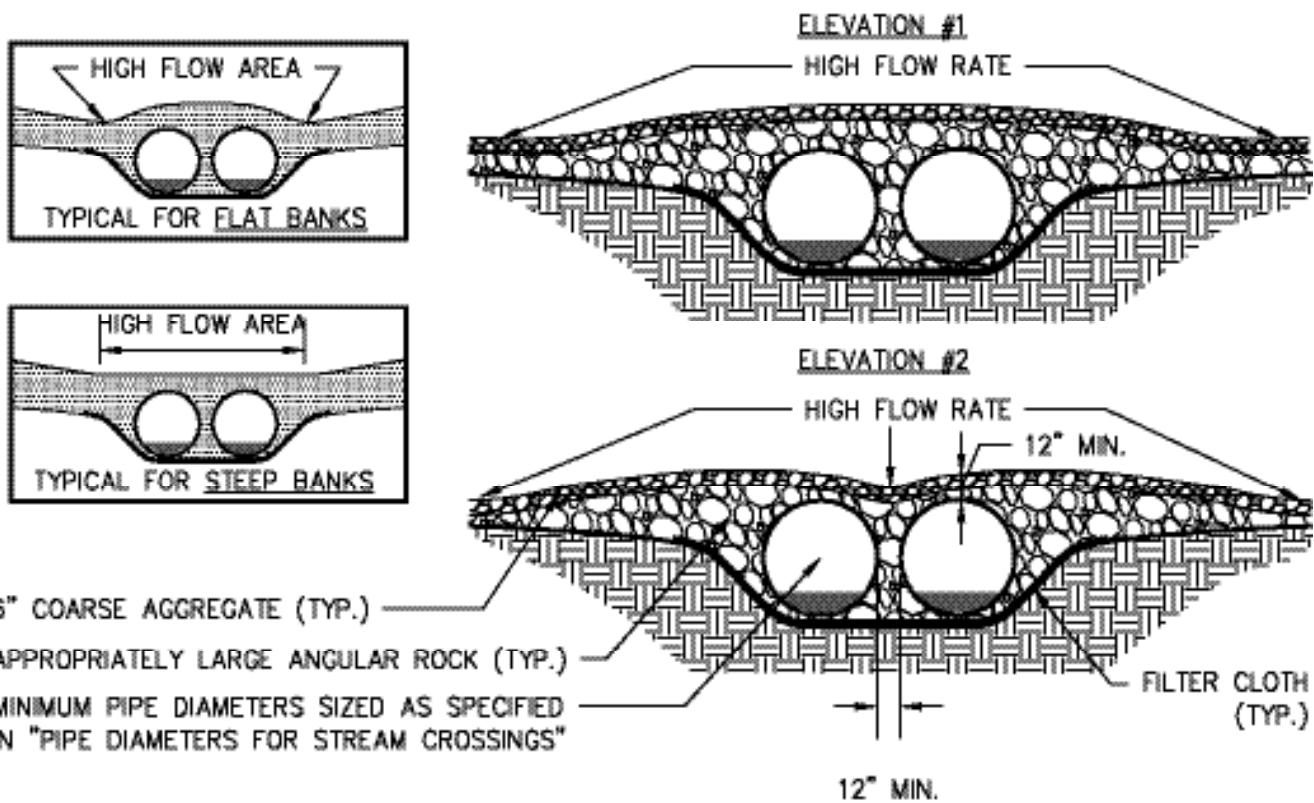

Figure 6-33.1 Temporary Stream Crossing

## CONFIGURATION OF TEMPORARY CULVERT CROSSINGS

(SECTIONS - NOT TO SCALE)



6" COARSE AGGREGATE (TYP.)  
 APPROPRIATELY LARGE ANGULAR ROCK (TYP.)  
 MINIMUM PIPE DIAMETERS SIZED AS SPECIFIED  
 IN "PIPE DIAMETERS FOR STREAM CROSSINGS"

### TYPICAL CULVERT CROSSING PLAN (NOT TO SCALE)

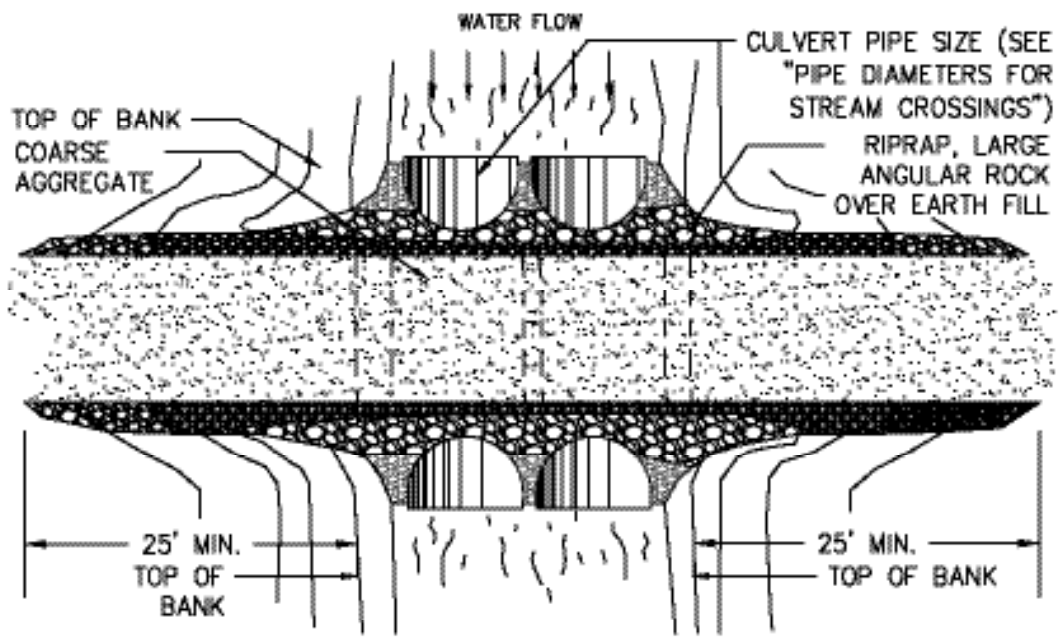

- NOTES:**
1. THIS TYPE OF CROSSING CAN BE INSTALLED IN BOTH A WET OR DRY WEATHER STREAM CONDITION WHERE THE DRAINAGE AREA EXCEEDS 10 ACRES.
  2. REMOVE DURING CLEANUP.

Figure 6-33.2



# Storm Drain Outlet Protection



## DEFINITION

Paved and/or riprapped channel sections, placed below storm drain outlets.

## PURPOSE

To reduce velocity of flow before entering receiving channels below storm drain outlets.

## CONDITIONS

This standard applies to all storm drain outlets, road culverts, paved channel outlets, etc., discharging into natural or constructed channels. Analysis and/or treatment will extend from the end of the conduit, channel or structure to the point of entry into an existing stream or publicly maintained drainage system.

## DESIGN CRITERIA

Structurally lined aprons at the outlets of pipes and paved channel sections shall be designed according to the following criteria:

### Capacity

Peak stormflow from the 25-year, 24-hour frequency storm or the storm specified in Title 12-7-1 of the Official Code of Georgia Annotated or the design discharge of the water conveyance structure, whichever is greater.

### Tailwater Depth

The depth of tailwater immediately below the pipe outlet must be determined for the design capacity of the pipe. Manning's Equation may be used to determine tailwater depth. If the tailwater depth is less than half the diameter of the outlet pipe, it shall be classified as a Minimum Tailwater Condition. If the tailwater depth is greater than half the pipe diameter, it shall be classified as a

Maximum Tailwater Condition. Pipes that outlet onto flat areas with no defined channel may be assumed to have a Minimum Tailwater Condition.

## Apron Length and Thickness

The apron length and  $d_{50}$ , stone median size, shall be determined from the curves according to tailwater conditions:

Minimum Tailwater- Use Figure 6-34.1

Maximum Tailwater- Use Figure 6-34.2

Maximum Stone Size =  $1.5 \times d_{50}$

Apron Thickness =  $1.5 \times d_{max}$

## Apron Width

If the pipe discharges directly into a well-defined channel, the apron shall extend across the channel bottom and up the channel banks to an elevation one foot above the maximum tailwater depth or to the top of the bank (whichever is less). If the pipe discharges onto a flat area with no defined channel, the width of the apron shall be determined as follows:

- The upstream end of the apron, adjacent to the pipe, shall have a width three times the diameter of the outlet pipe.
- For a Minimum Tailwater Condition, the downstream end of the apron shall have a width equal to the pipe diameter plus the length of the apron. Refer to Figure 6-34.1.
- For a Maximum Tailwater Condition, the down stream end shall have a width equal to the pipe diameter plus 0.4 times the length of the apron. Refer to Figure 6-34.2.

## Bottom Grade

The apron shall be constructed with no slope along its length (0.0% grade). The invert elevation of the downstream end of the apron shall be equal to the elevation of the invert of the receiving channel. There shall be no overfall at the end of the apron.

## Side Slope

If the pipe discharges into a well-defined channel, the side slopes of the channel shall not be steeper than 2:1.



## Alignment

The apron shall be located so that there are no bends in the horizontal alignment.

## Geotextile

Geotextiles should be used as a separator between the graded stone, the soil base, and the abutments. The geotextile will prevent the migration of soil particles from the subgrade into the graded stone. The geotextile shall be specified in accordance with AASHTO M288-96 Section 7.5, *Permanent Erosion Control Recommendations*. The geotextile should be placed immediately adjacent to the subgrade without any voids.

## Materials

The apron may be lined with riprap, grouted riprap, or concrete. The median sized stone for riprap,  $d_{50}$ , shall be determined from the curves, Figures 6-34.1 and 6-34.2, according to the tail-water condition. The gradation, quality and placement of riprap shall conform to Appendix C.

Refer to Figure 6-34.4, for alternative structures to achieving energy dissipation at an outlet. For information regarding the selection and design of these alternative energy dissipators, refer to:

FHWA Standard (REF. [Hydraulic Design of Energy Dissipators for Culverts and Channels](#); HEC No. 14, FHWA, Available from the Superintendent of Documents, U.S. Government Printing Office, Washington, D.C. 20402.

## CONSTRUCTION SPECIFICATIONS

1. Ensure that the subgrade for the filter and riprap follows the required lines and grades shown in the plan. Compact any fill required in the subgrade to the density of the surrounding undisturbed material. Low areas in the subgrade on undisturbed soil may also be filled by increasing the riprap thickness.
2. The riprap and gravel filter must conform to the specified grading limits shown on the plans.
3. Geotextile must meet design requirements and be properly protected from punching or tearing during installation. Repair any damage by removing the riprap and placing another piece of filter fabric over the damaged area. All connecting joints should overlap a

minimum of 1 ft. If the damage is extensive, replace the entire filter fabric.

4. Riprap may be placed by equipment, but take care to avoid damaging the filter.
5. The minimum thickness of the riprap should be 1.5 times the maximum stone diameter.
6. Construct the apron on zero grade with no overfall at the end. Make the top of the riprap at the downstream end level with the receiving area or slightly below it.
7. Ensure that the apron is properly aligned with the receiving stream and preferably straight throughout its length. If a curve is needed to fit site conditions, place it in the upper section of the apron.
8. Immediately after construction, stabilize all disturbed areas with vegetation.
9. Stone quality - Select stone for riprap from field stone or quarry stone. The stone should be hard, angular, and highly weather-resistant. The specific gravity of the individual stones should be at least 2.5.
10. Filter - Install a filter to prevent soil movement through the openings in the riprap. The filter should consist of a graded gravel layer or a synthetic filter cloth. See Appendix C; p. C-1.

## MAINTENANCE

Inspect riprap outlet structures after heavy rains to see if any erosion around or below the riprap has taken place or if stones have been dislodged. Immediately make all needed repairs to prevent further damage.

TO BE SHOWN ON THE EROSION AND SEDIMENT CONTROL PLAN

1. The flow characteristics of the pipe at full flow including pipe diameter, flow rate (cfs), velocity (fps), and tail-water condition.
2. The dimensions of the apron including length ( $L_a$ ), width at the headwall ( $W_1$ ), downstream width ( $W_2$ ), average stone diameter ( $d_{50}$ ), and stone depth ( $D$ ) designed in accordance with Figures 6-34.1 and 6-34.2.

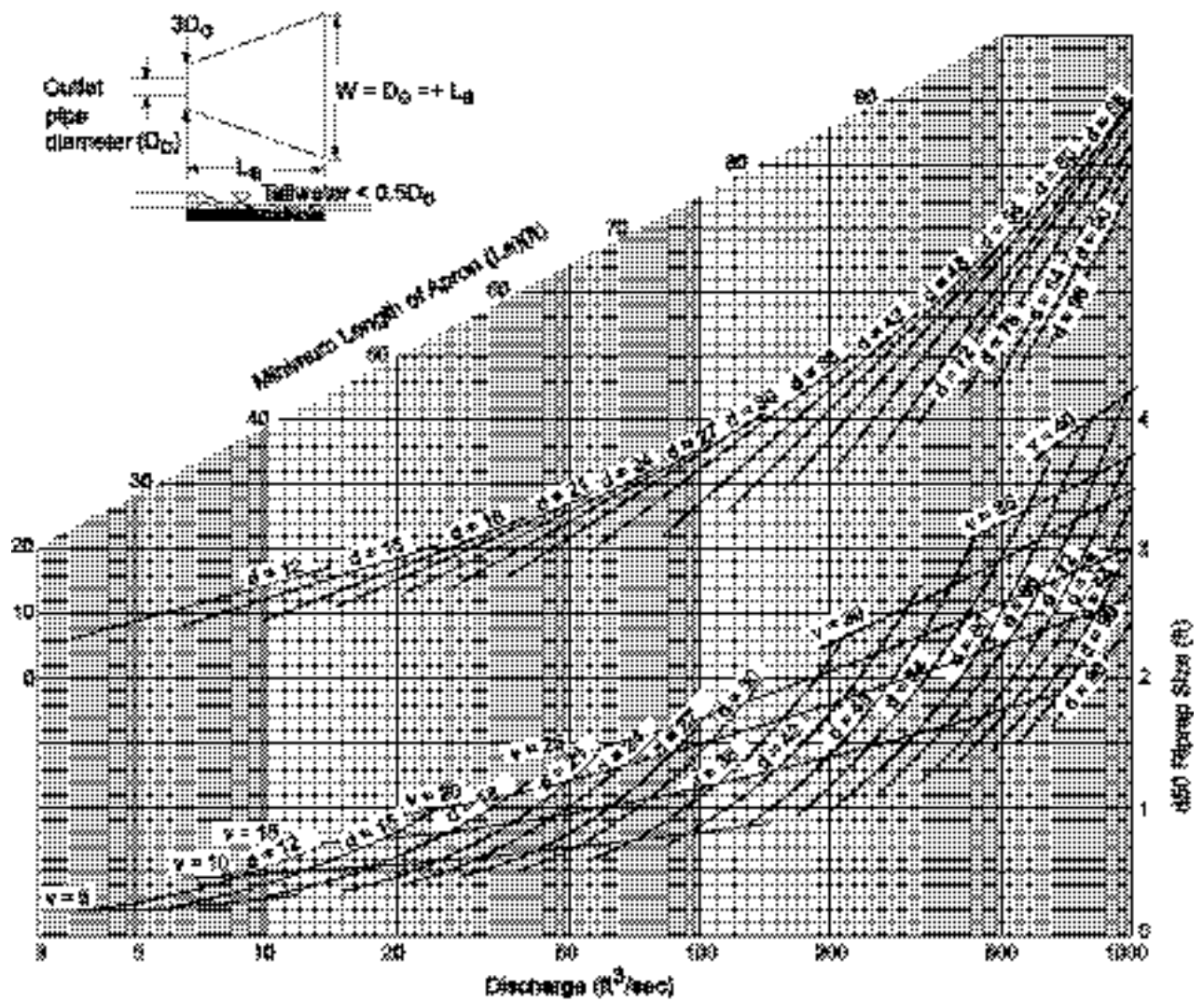

Curves may not be extrapolated.

Figure 6-34.1 - Design of Outlet Protection From a Round Pipe Flowing Full, Minimum Tailwater Condition ( $T_w < 0.5$  Diameter)

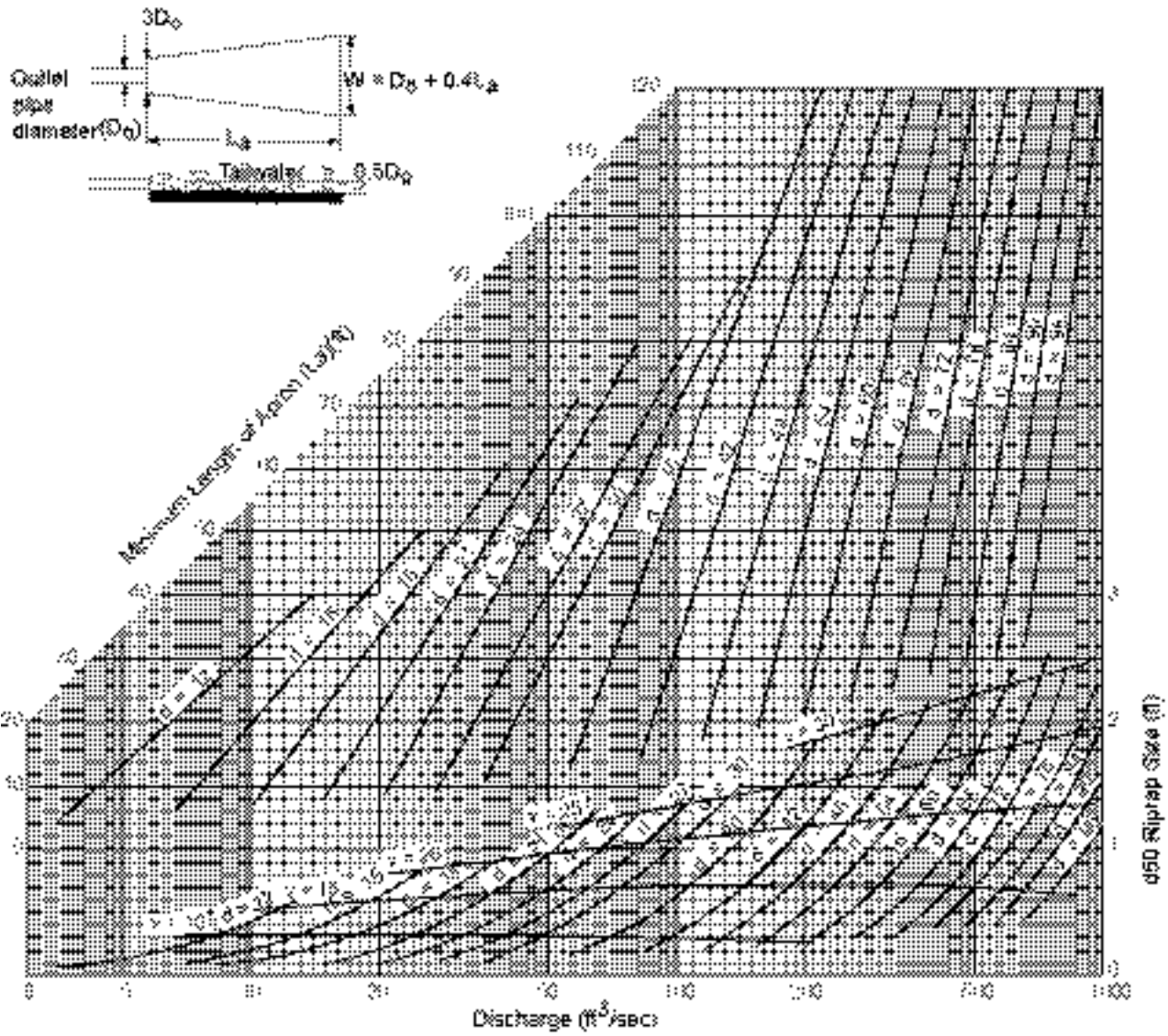

Curves may not be extrapolated.

Figure 6-34.2 - Design of Outlet Protection From a Round Pipe Flowing Full, Maximum Tailwater Condition ( $T_w > 0.5$  Diameter)

# RIPRAP OUTLET PROTECTION

## PIPE OUTLET TO FLAT AREA -- NO WELL DEFINED CHANNEL

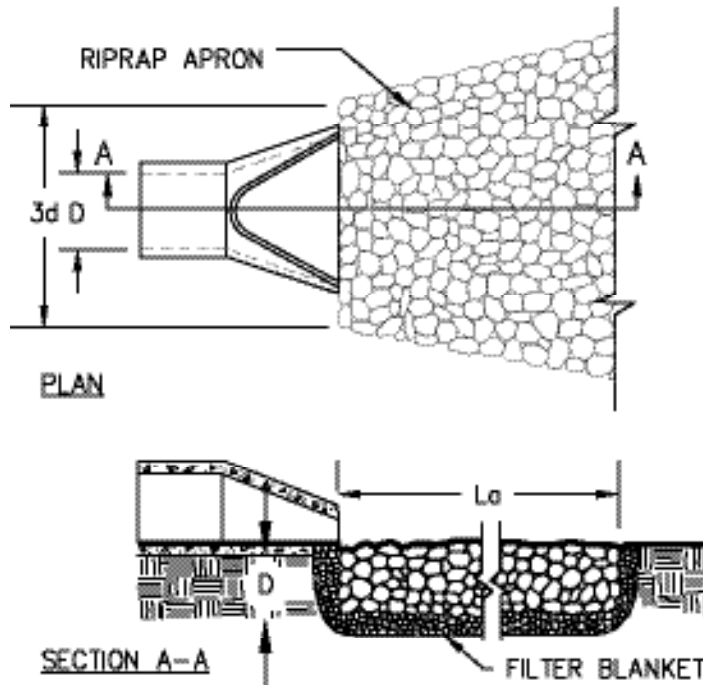

### NOTES:

1.  $L_o$  IS THE LENGTH OF THE RIPRAP APRON.
2.  $D = 1.5$  TIMES THE MAXIMUM STONE DIAMETER BUT NOT LESS THAN 6".
3. IN A WELL-DEFINED CHANNEL, EXTEND THE APRON UP THE CHANNEL BANKS TO AN ELEVATION OF 6" ABOVE THE MAXIMUM TAILWATER DEPTH OR TO THE TOP OF THE BANK (WHICHEVER IS LESS).
4. A FILTER BLANKET OR FILTER FABRIC SHOULD BE INSTALLED BETWEEN THE RIPRAP AND THE SOIL FOUNDATION.

## PIPE OUTLET TO WELL DEFINED CHANNEL

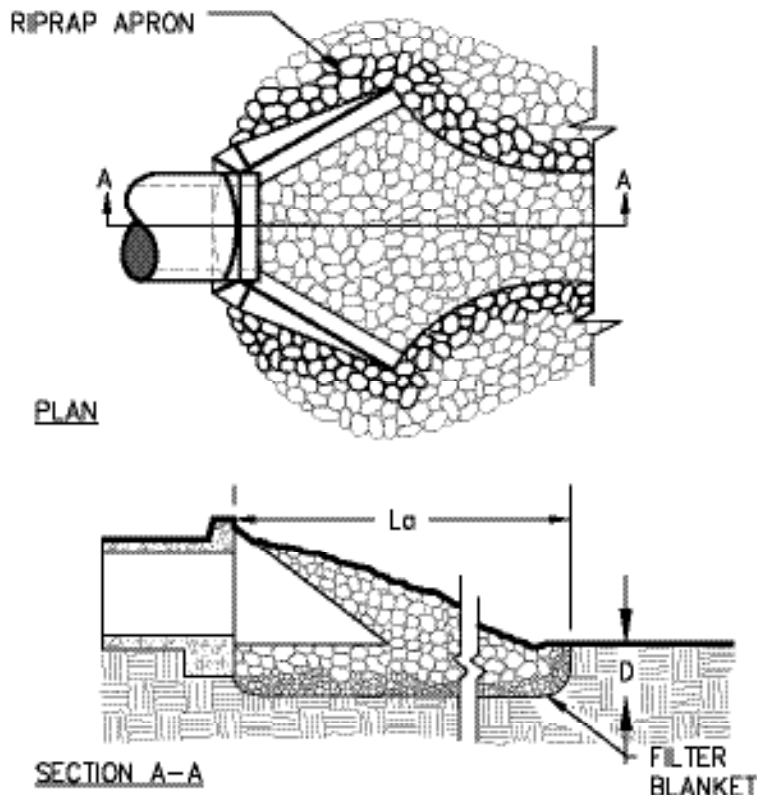
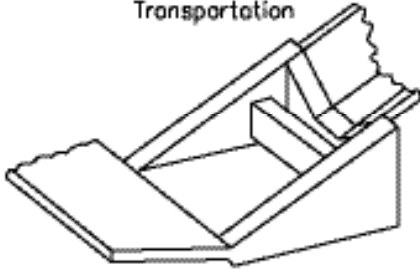

Figure 6-34.3 - Riprap Outlet Protection (Modified From Va SWCC)

# ALTERNATE STRUCTURES FOR ENERGY DISSIPATION AT AN OUTLET

(Modified from Goldman, Jackson, and Bursztynsky)

Virginia Department of Highways and Transportation



Colorado State University Rigid Boundary Basin

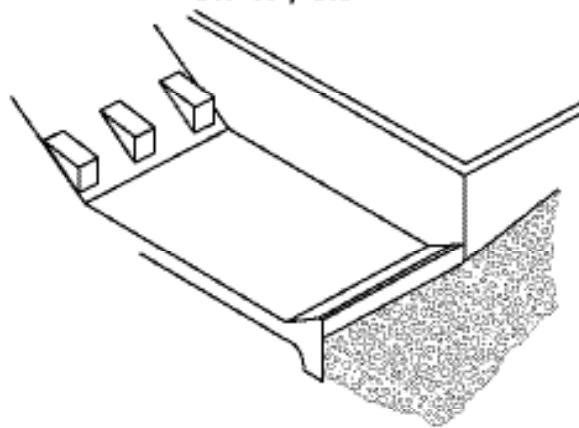

USBR Type IV Basin

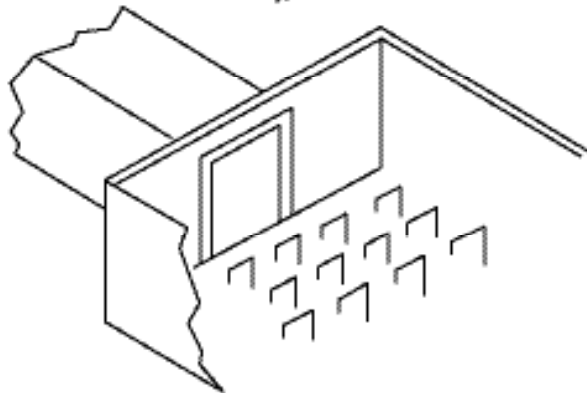

St. Anthony Falls Stilling Basin



Contra Costa County, Calif.

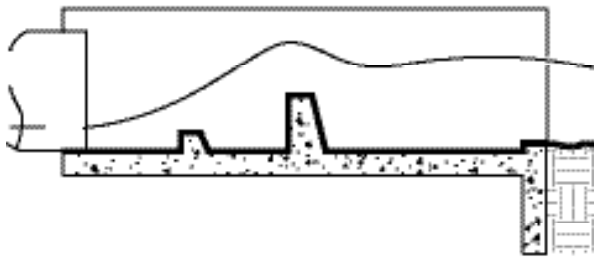

Straight Drop Spillway Stilling Basin

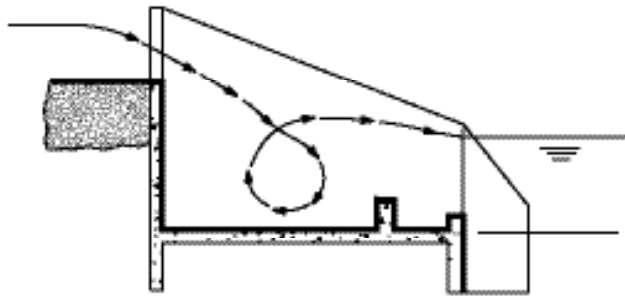

USBR Type VI Baffle Wall Basin

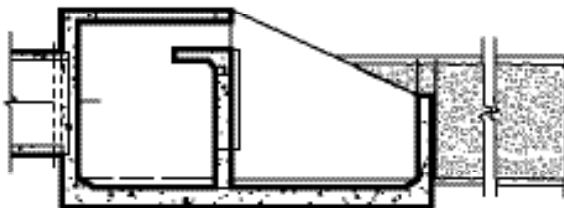

T-fitting on CMP Outlet



Figure 6-34.4



# Surface Roughening

Su



## DEFINITION

Providing a rough soil surface with horizontal depressions created by operating a tillage or other suitable implement on the contour, or by leaving slopes in a roughened condition by not fine-grading them.

## PURPOSE

The purposes of surface roughening are to aid in establishment of vegetative cover with seed, to reduce runoff velocity and increase infiltration, reduce erosion and provide for sediment trapping.

## CONDITIONS

All slopes steeper than 3:1 require surface roughening, either stair-step grading, grooving, furrowing, or tracking if they are to be stabilized with vegetation. However, if the slope is to be stabilized with erosion control blankets or soil reinforcement matting, the soil surface should not be roughened.

Areas with grades less steep than 3:1 should have the soil surface lightly roughened and loosened to a depth of 2 to 4 inches prior to seeding. Areas that have been graded and will not be stabilized immediately may be roughened to reduce runoff velocity until seeding takes place. Slopes with a stable rock face do not require roughening or stabilization.

## DESIGN CRITERIA

Graded areas with smooth, hard surfaces give a false impression of “finished grading” and a job well done. It is difficult to establish vegetation on such surfaces due to reduced water infiltration and the potential for erosion. Rough

slope surfaces with uneven soil and rocks left in place may appear unattractive or unfinished at first, but encourage water infiltration, speed up the establishment of vegetation, and decrease runoff velocity. Rough, loose soil surfaces give lime, fertilizer and seed some natural coverage. Niches in the surface provide microclimates that generally provide a cooler and more favorable moisture level than hard flat surfaces. This aids seed germination.

There are different methods of achieving a roughened soil surface on a slope, and the selection of an appropriate method depends upon the type of slope. Roughening methods include stair-step grading, grooving, and tracking. Factors to be considered in choosing a method are slope steepness, mowing requirements, and whether the slope is formed by cutting or filling.

1. Disturbed areas that will not require mowing may be stair-step graded, grooved, or left rough after filling.
2. Stair-step grading is particularly appropriate in soils containing large amounts of soft rock. Each “step” catches material that sloughs from above, and provides a level site where vegetation can become established.
3. Areas that will be mowed (these areas should have slopes less steep than 3:1) may have small furrows left by discing, harrowing, raking, or seed planting machinery operated on the contour.
4. It is important to avoid excessive compacting of the soil surface when scarifying. Tracking with bulldozer treads is preferable to not roughening at all, but it is not as effective as other forms of roughening, as the soil surface is severely compacted and runoff is increased.

## CONSTRUCTION SPECIFICATIONS

### Cut Slopes Steeper than 3:1

Cut slopes with a gradient steeper than 3:1 should not be mowed. They shall be stair-step graded or grooved (see Figure 6-35.1).

1. *Stair-step grading* may be carried out on any material soft enough to be ripped with a bulldozer. Slopes consisting of soft rock with some subsoil are particularly suited to stair-step grading.



The ratio of the vertical cut distance to the horizontal distance shall be less than 1:1 and the horizontal portion of the “step” shall slope toward the vertical wall.

Individual vertical cuts shall not be more than 30 inches on soft soil material and not more than 40 inches in rocky materials.

2. *Grooving* consists of using machinery to create a series of ridges and depressions that run perpendicular to the slope (on the contour).

Grooves may be made with any appropriate implement that can be safely operated on the slope and that will not cause undue compaction. Suggested implements include discs, tillers, spring harrows, and the teeth on a front-end loader bucket. Such grooves shall not be less than 3 inches deep nor further than 15 inches apart.

### **Fill Slopes Steeper than 3:1**

Fill slopes with a gradient steeper than 3:1 should not be mowed. They shall be grooved or allowed to remain rough as they are constructed. Method (1) or (2) below may be used.

1. Groove according to #2 of “Cut Slopes Steeper than 3:1”.
2. As lifts of the fill are constructed, soil and rock material may be allowed to fall naturally onto the slope surface (see Figure 6-35.1).

Colluvial materials (soil deposits at the base of slopes or from old stream beds) shall not be used in fills as they flow when saturated.

### **Cuts, Fills, and Graded Areas That Will Be Mowed (less than 3:1)**

Mowed slopes should not be steeper than 3:1. Excessive roughness is undesirable where mowing is planned.

These areas may be roughened with shallow grooves such as remain after tilling, discing, harrowing, raking, or use of a multipacker-seeder. The final pass of any such tillage implement shall be on the contour (perpendicular to the slope).

Grooves formed by such implements shall be not less than one inch deep and not further than

12 inches apart.

Fill slopes that are left rough as constructed may be smoothed with a dragline or pickchain to facilitate mowing.

### **Roughening With Tracked Machinery**

Roughening with tracked machinery on clayed soils is not recommended unless no alternatives are available. Undue compaction of surface soil results from this practice. Sandy soils do not compact severely and may be tracked. In no case is tracking as effective as the other roughening methods described.

When tracking is the chosen surface roughening technique, it shall be done by operating tracked machinery up and down the slope to leave horizontal depressions in the soil. As few passes of the machinery as possible should be made to minimize compaction.

### **Seeding**

Roughened areas shall be seeded and mulched as soon as possible to obtain optimum seed germination and seeding growth. Refer to specifications **Ds1, Ds2, Ds3, and Ds4 - Disturbed Area Stabilization (With Mulching Only, Temporary Seeding, Permanent Vegetation, and Sodding)**, respectively.

## STAIR STEPPING CUT SLOPES

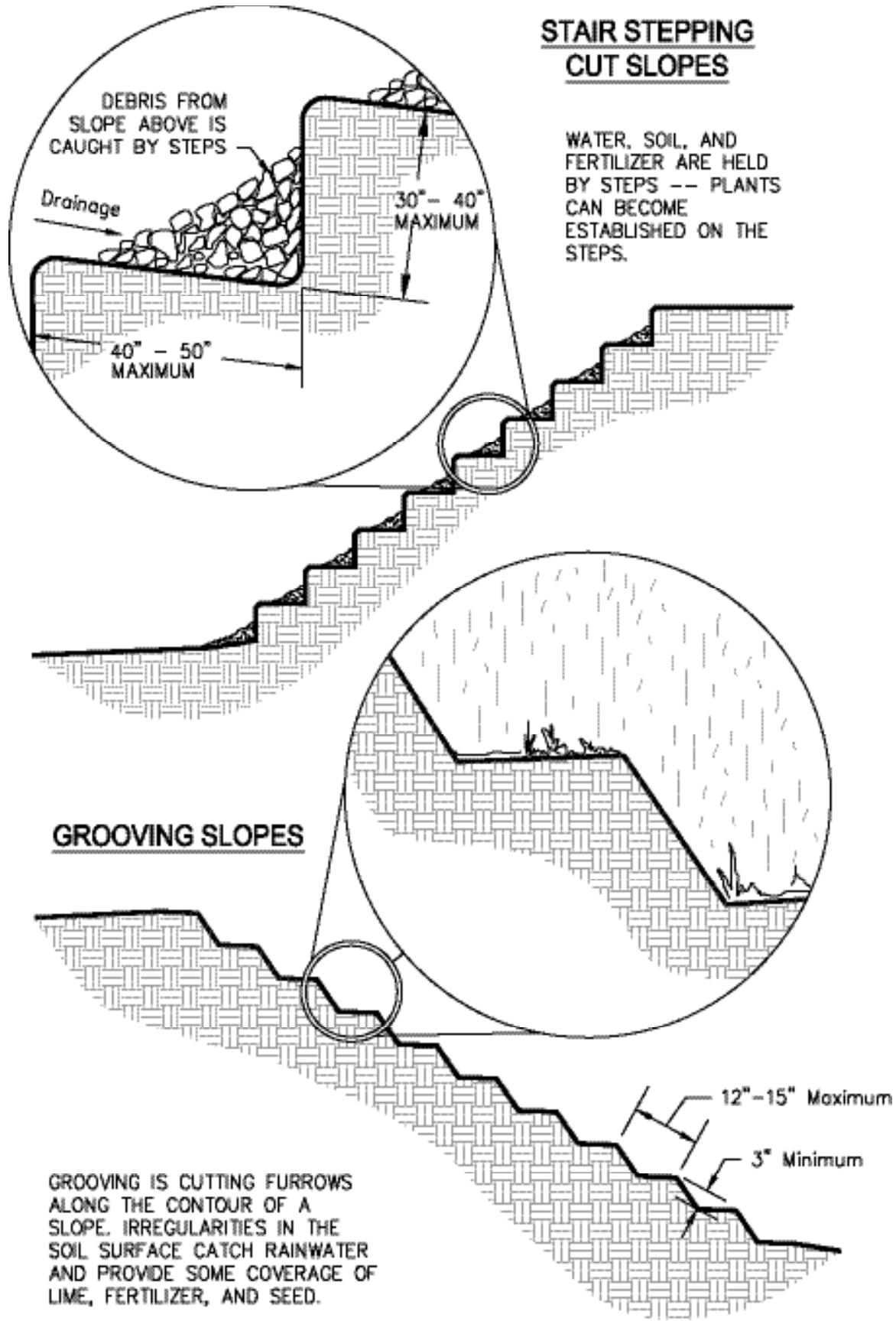
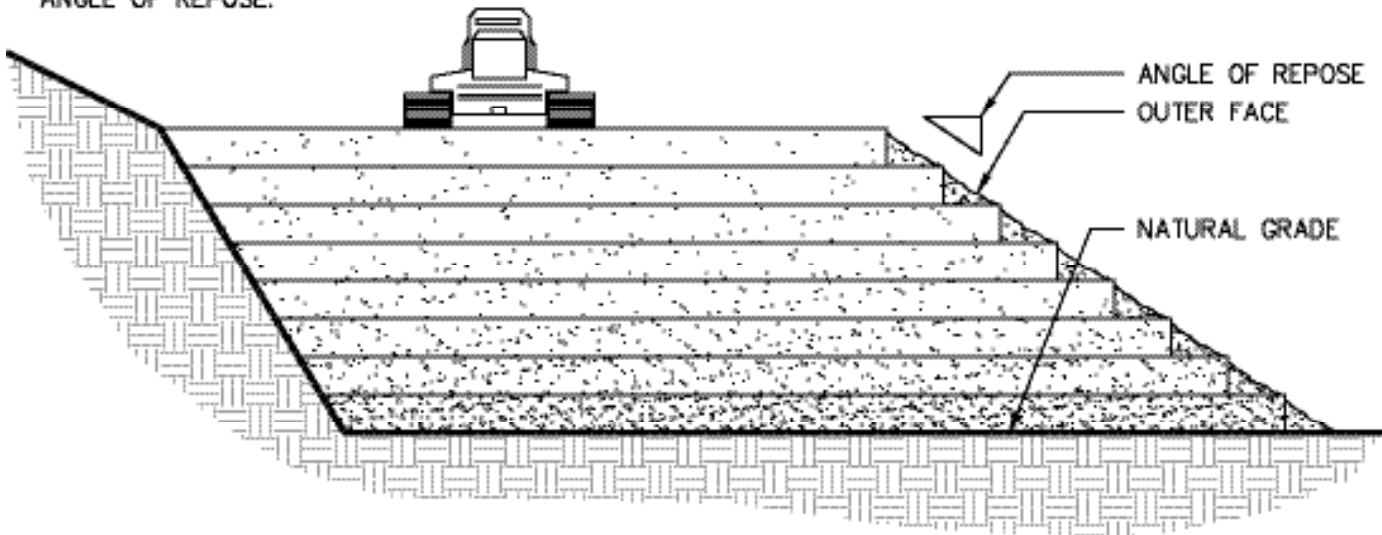

Figure 6-35.1

## FILL SLOPE TREATMENT

EACH LIFT OF THE FILL IS COMPACTED, BUT THE OUTER FACE OF THE SLOPE IS ALLOWED TO REMAIN LOOSE SO THAT THE ROCKS, CLODS, ETC. REACH THE NATURAL ANGLE OF REPOSE.



## TRACKING

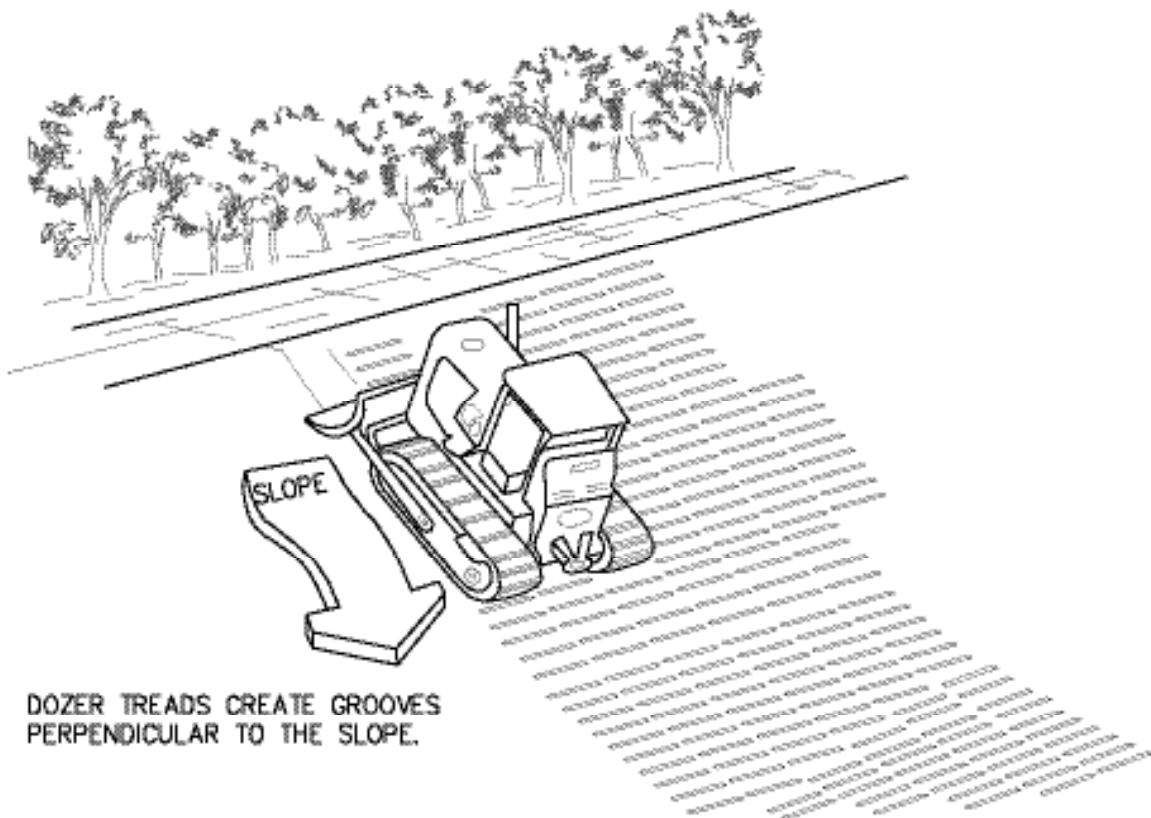

DOZER TREADS CREATE GROOVES PERPENDICULAR TO THE SLOPE.

Figure 6-35.2

# Turbidity Curtain

Tc



## DEFINITION

A floating or staked barrier installed within the water. (It may also be referred to as a floating boom, silt barrier or silt curtain).

## PURPOSE

Turbidity curtains are installed to minimize turbidity and silt migration from work occurring within the water or as a supplement to perimeter control BMPs at the water's edge. Silt or turbidity is confined to the area within the boundary created by the installation, such that suspended particles drop out of the water column over time.

## CONDITIONS

By its nature, a turbidity curtain encourages a controlled deposition of silt or sediment. A turbidity curtain is only allowed as a primary device when required permitting has been obtained for the site that approves the filling of State or U.S. waters. The unauthorized storing of sediment in waters of the State is strictly prohibited.

The installation of a Tc as a supplemental BMP that in no way represents perimeter control, is allowed provided the stream, river or "water" substrate or bottom will not be altered in any manner by the installation.

The owner, operator and design professional are cautioned that State or LIA water buffer and variance requirements may apply to bank and shoreline installations.

## PLANNING CONSIDERATIONS

Careful assessment of the depth, flow or current of water and nature of construction is needed in order to determine if floating or staked

installations are warranted.

## DESIGN CRITERIA

Formal design is not required but the following guidelines have been established:

Depending upon the installation conditions (see Construction Specifications), curtain material may be comprised of suitable impermeable materials such as heavy polyethylene film, or suitable permeable materials such as canvas duck.

## Floating Turbidity Curtains Tc-F

Tc-F

Typical installations include large bodies of water such as rivers and lakes.

## Staked Turbidity Curtains Tc-S

Tc-S

Typical installations include shallow inundations where construction is required. It may be used to protect a small stream while it is being realigned or restored. In this case the barrier should extend to the bottom of the streambed. The height should be limited to 5 feet whenever possible and extend 2 feet above the normal water elevation.

## CONSTRUCTION SPECIFICATIONS

Whenever possible, place barrier approximately 25 feet outside of the affected construction area for large water bodies. Installations less than 25 feet from the work are allowed, however narrower confinements promote proportionate sedimentation. Curtain depth should reach a depth within 5 feet of the bottom for floating installations. If the body of water has significant velocity or current, place the barrier parallel to the flow and ensure the curtain is permeable.

In smaller streams the barrier should be placed close to the construction area.

Installation dimensions and methods shall be fitted to the conditions, permitted activity and construction methods. **In no instance shall the silt dispersion exceed the allowances the filling permit has authorized.** The permittee is reminded to be a good steward of our resources by minimizing the migration and sedimentation regardless of permits obtained.

Barriers shall be either staked or floating depending upon current, tides, water depth and other variables. When staked barriers are used in stream relocations or widening, the curtain shall be permeable, weighted at the bottom and not be trenched in.

## **MAINTENANCE**

For installations that permit the placement of fill within the water body, maintenance consists of removing the Turbidity Curtain when it is no longer required. If the deposition exceeds the allowances of the filling permit, careful removal of the sediment is required and shall be performed in a manner that is consistent with all other applicable permits.

If the installation is made as a supplemental BMP, the Tc should be removed after final stabilization of the contributing drainage area and perimeter control removal has occurred.

# TURBIDITY CURTAIN SYSTEM

## ANCHOR SYSTEM AND LAYOUT DETAILS

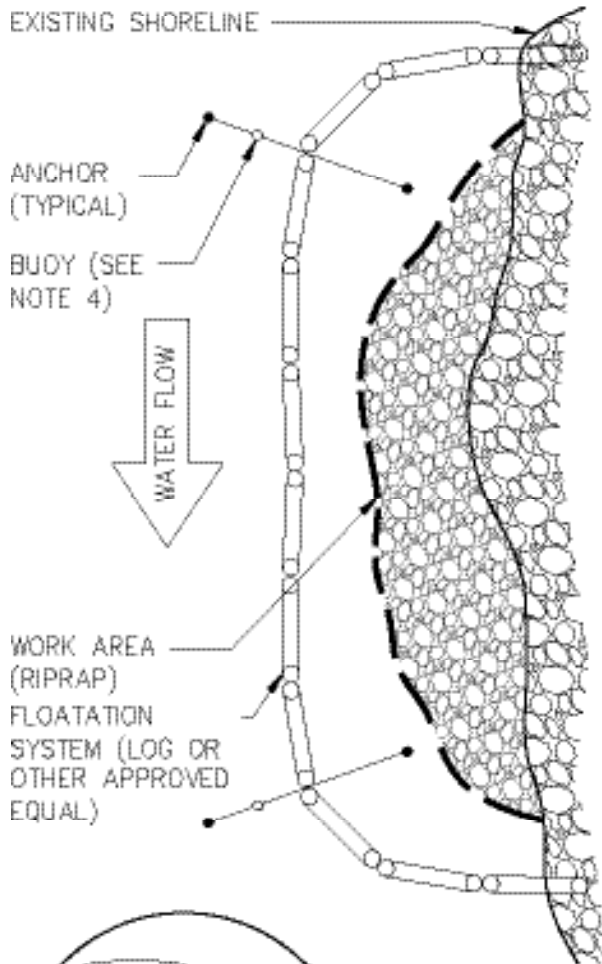

### NOTES:

1. SILT CURTAINS SHOULD BE ORIENTED PARALLEL TO THE DIRECTION OF FLOW.
2. FOR SITES NOT SUBJECT TO HEAVY WAVE ACTION, THE CURTAIN HEIGHT SHALL PROVIDE SUFFICIENT SLACK TO ALLOW THE TOP OF THE CURTAIN TO RISE TO THE MAXIMUM EXPECTED HIGH-WATER LEVEL (INCLUDING WAVES) WHILE THE BOTTOM MAINTAINS CONTINUOUS CONTACT WITH THE BOTTOM OF THE WATER BODY. THE BOTTOM EDGE OF THE CURTAIN SHALL HAVE A WEIGHT SYSTEM CAPABLE OF HOLDING THE BOTTOM OF THE CURTAIN DOWN AND CONFORMING TO THE BOTTOM OF THE WATER BODY, SO AS TO PROHIBIT ESCAPE OF TURBID WATER UNDER THE CURTAIN.
3. THE SILT CURTAIN SHALL BE LOCATED BEYOND THE LATERAL LIMITS OF THE CONSTRUCTION SITE AND FIRMLY ANCHORED INTO PLACE (THE ALIGNMENT SHOULD BE SET AS CLOSE TO THE WORK AREA AS POSSIBLE BUT NOT SO CLOSE AS TO BE DISRUPTED BY CONSTRUCTION EQUIPMENT).
4. DANGER BUOYS SHALL BE USED AS DIRECTED BY THE COAST GUARD OR DNR PERMIT WHEN WORKING IN NAVIGABLE WATERS.
5. THE ENDS OF THE SILT CURTAIN SHALL BE SECURELY ANCHORED AND KEYED IN ORDER TO ENCLOSE AREA.
6. A GENERAL RULE OF THUMB FOR ATTACHING ANCHORS IS TO DO SO AT 100' INTERVALS (DEPENDING ON CURRENT AND TIDAL CONDITIONS, IT MAY BE NECESSARY TO ANCHOR THE BARRIER ON BOTH SIDES—AS SHOWN).

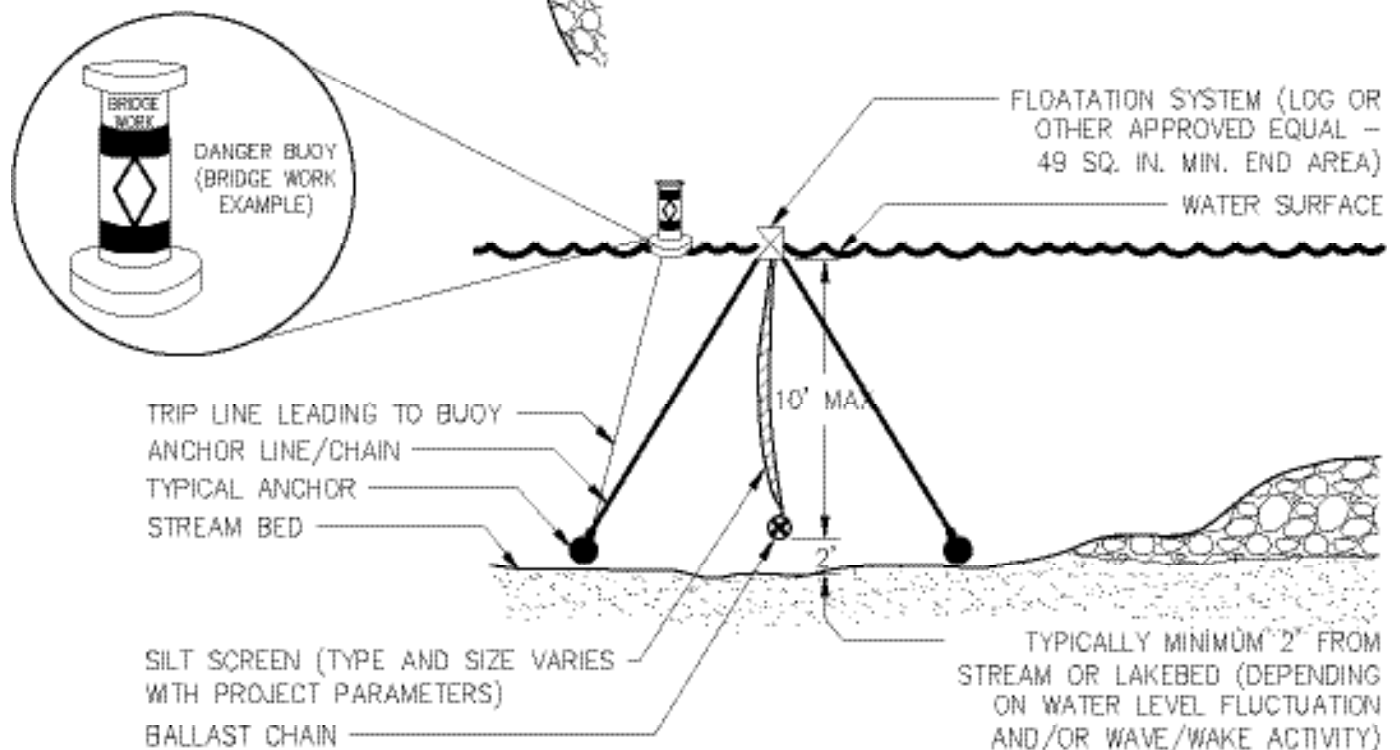
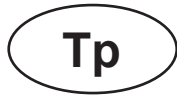

Figure 6-36.1



# Topsoiling



## DEFINITION

Stripping off the more fertile top soil, storing it, then spreading it over the disturbed area after completion of construction activities.

## PURPOSE

To provide a suitable soil medium for vegetative growth on areas where other measures will not produce or maintain a desirable stand.

## CONDITIONS

This practice is recommended for sites of 2:1 or flatter slopes where:

1. The texture of the exposed subsoil or parent material is not suitable to produce adequate vegetative growth.
2. The soil material is so shallow that the rooting zone is not deep enough to support plants with continuing supplies of moisture and food.
3. The soil to be vegetated contains material toxic to plant growth.

## CONSTRUCTION SPECIFICATIONS

### Materials

Topsoil should be friable and loamy, free of debris, objectionable weeds and stones and contain no toxic substance that may be harmful to plant growth. A pH range of 5.0-7.5 is acceptable. Soluble salts should not exceed 500 ppm.

### Testing

Field exploration should be made to determine whether the quantity and quality of surface soil justifies stripping.

## Stripping

Stripping should be confined to the immediate construction area.

A 4 to 6 inch stripping depth is common, but may vary depending on the particular soil.

## Topsoil pH

If pH value is less than 6.0, lime shall be applied and incorporated with the topsoil to adjust the pH to 6.5 or higher. Topsoils containing soluble salts greater than 500 parts per million shall not be used.

## Stockpiles

The location of topsoil stockpiles should not obstruct natural drainage or cause off-site environmental damage.

## Stabilization

Stockpiles shall be contained by sediment barriers to prevent sedimentation on adjacent areas. Stockpiles shall be stabilized in accordance with specifications **Ds1 and Ds2 - Disturbed Area Stabilization (With Mulching) and (With Temporary Grassing)**, respectively, or **Tac-Tackifiers**.

## Site Preparation

### (Where topsoil is to be added)

**Topsoiling** - When topsoiling, maintain needed erosion control practices such as diversions, grade stabilization structures, berms, dikes, level spreaders, waterways, sediment basins, etc.

**Grading** - Grades on the areas to be topsoiled that have been previously established shall be maintained.

**Liming** - Soil tests should be used to determine the pH of the soil. Where the pH of the subsoil is 5.0 or less or composed of heavy clays, agricultural limestone shall be spread at the rate of 100 pounds per 1,000 square feet. Lime shall be distributed uniformly over designated areas and worked into the soil in conjunction with tillage operations as described in the following procedure.

**Bonding** - Use one of the following methods to insure bonding of topsoil and subsoil:

1. Tilling. After the areas to be topsoiled have



been brought to grade, and immediately prior to dumping and spreading the topsoil, the subgrade shall be loosened by discing or scarifying to a depth of at least 3 inches to permit bonding of the topsoil to the subsoil.

2. Tracking. Passing a bulldozer over the entire surface area of the slope to leave horizontal depressions.

**Applying Topsoil**

1. Topsoil should be handled only when it is dry enough to work without damaging soil structure.
2. A uniform application of 5 inches (unsettled) is recommended, but may be adjusted at the discretion of the design professional.

Table 6-37.1. Cubic Yards Of Topsoil Required For Application To Various Depths

<u>Depth (Inches)</u>	<u>Per 1,000 Square Feet</u>	<u>Per Acre</u>
1	3.1	134
2	6.2	268
3	9.3	403
4	12.4	537
5	15.5	672
6	18.6	806

# Tree Protection



## DEFINITION

To protect desirable trees from injury during construction activity.

## PURPOSE

To ensure the survival of desirable trees where they will be effective for erosion and sediment control, watershed protection, landscape beautification, dust and pollution control, noise reduction, shade and other environmental benefits while the land is being converted from forest to urban-type uses.

## CONSTRUCTION ACTIVITIES

Trees can be damaged or killed by a wide variety of construction activities. Obvious injuries such as broken branches or torn bark deplete the tree's resources and provide entry points for insects, or for diseases such as Oak Wilt.

The worst damage, however, often remains hidden underground. Roots are one of the most vital parts of a tree. They are responsible for nutrient and water uptake, energy storage and anchoring the plant. It is critical that you protect roots that lie in the path of construction.

Soil compaction is the leading killer of urban trees. Tree roots need loose soil to grow, obtain oxygen, and absorb water and nutrients. Stockpiled building materials, heavy machinery, and excessive foot traffic, all damage soil structure. Lacking good soil aeration, roots suffocate and tree health declines.

## Requirement for Regulatory Compliance

Many cities and counties in Georgia have

tree protection specifications written in their local ordinances. In some areas a permit is needed to remove trees with a specified diameter. It is important for property owners and design professionals to contact the local government to obtain information regarding tree ordinances BEFORE ES&PC plans are designed. Failure to do so could result in heavy fines or delay in construction.

## DESIGN CRITERIA

No formal design is required. However, in planning, a number of criteria must be considered.

### Tree Protection Zones:

1. Measure the diameter of the tree trunk in inches at 4.5 feet from the ground. This is called the Diameter Breast Height or DBH.
2. Multiply this value by 1.5. This result is the diameter of the root protection zone in feet. This is also considered the critical rooting distance.

Once the size of the area is determined, consider fencing materials. Orange tree save fencing or black silt fencing are commonly used.

These materials are easy to install but they often get knocked down or removed when it is inconvenient to go around the tree save area. In some cases more permanent materials, such as chain link fencing, may be required. Whatever fencing material is used, it must be maintained throughout the construction process.

### Tree Protection Zone Fencing:

Tree protection zone fencing may be one of the following:

1. For areas of large remnant forest to be protected use 4 feet high orange plastic fabric fencing stapled in three locations to treated wood 2x4 stakes. Set stakes 6 feet on center. Rebar is not to be used for stakes. Figure 6-38.1
2. For single family homes use a treated wood fencing as shown on detail. It may have orange fabric attached to it.
3. For all other developments use 6 feet high

chain link fencing attached to galvanized metal post as shown on detail. Figure 6-38.2

# TREE PROTECTION

## "SNOW" FENCE

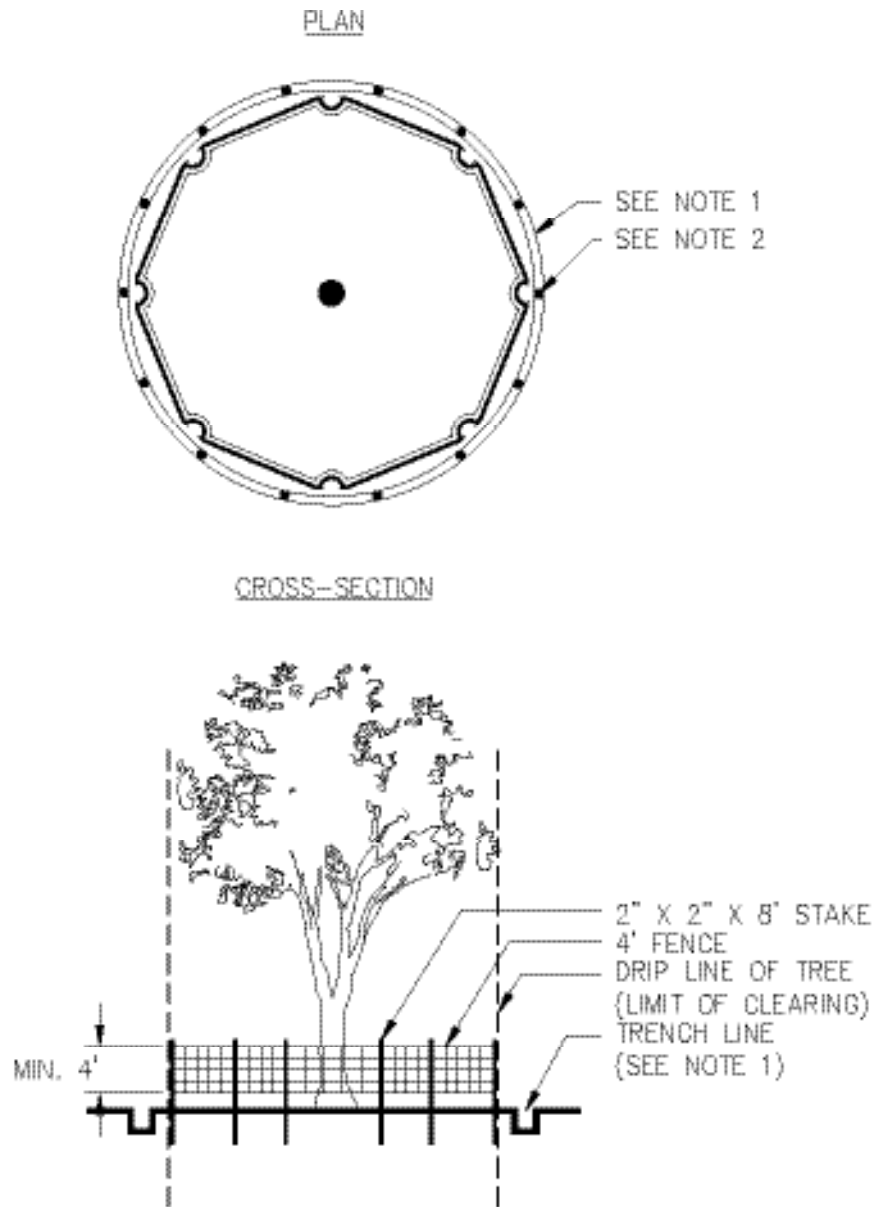

### NOTES:

1. USE TRENCHER (I.E. DITCH WHICH) TO CUT A 4"-5" W X 18" D TRENCH ALONG DRIP LINE (LIMIT OF CLEARING) AND BACKFILL WITH SAND AND LIGHTLY COMPACT.
2. SPACE STAKES AT INTERVALS SUFFICIENT TO MAINTAIN ALL FENCING OUT OF DRIP LINE OR AS SHOWN BY ENGINEER (SET STAKES NO GREATER THAN 6 FEET ON CENTER-REBAR IS NOT TO BE USED FOR STAKES).
3. MAINTAIN FENCE BY REPAIRING AND/OR REPLACING DAMAGED FENCE. DO NOT REMOVE FENCING PRIOR TO LANDSCAPING OPERATIONS.
4. DO NOT STORE OR STACK MATERIALS, EQUIPMENT, OR VEHICLES WITHIN FENCED AREA.
5. FENCE SHALL BE ORANGE VINYL "SNOW FENCE" 4' HIGH MINIMUM.

**Figure 6-38.1**

# TREE PROTECTION

## CHAIN LINK FENCE DETAIL

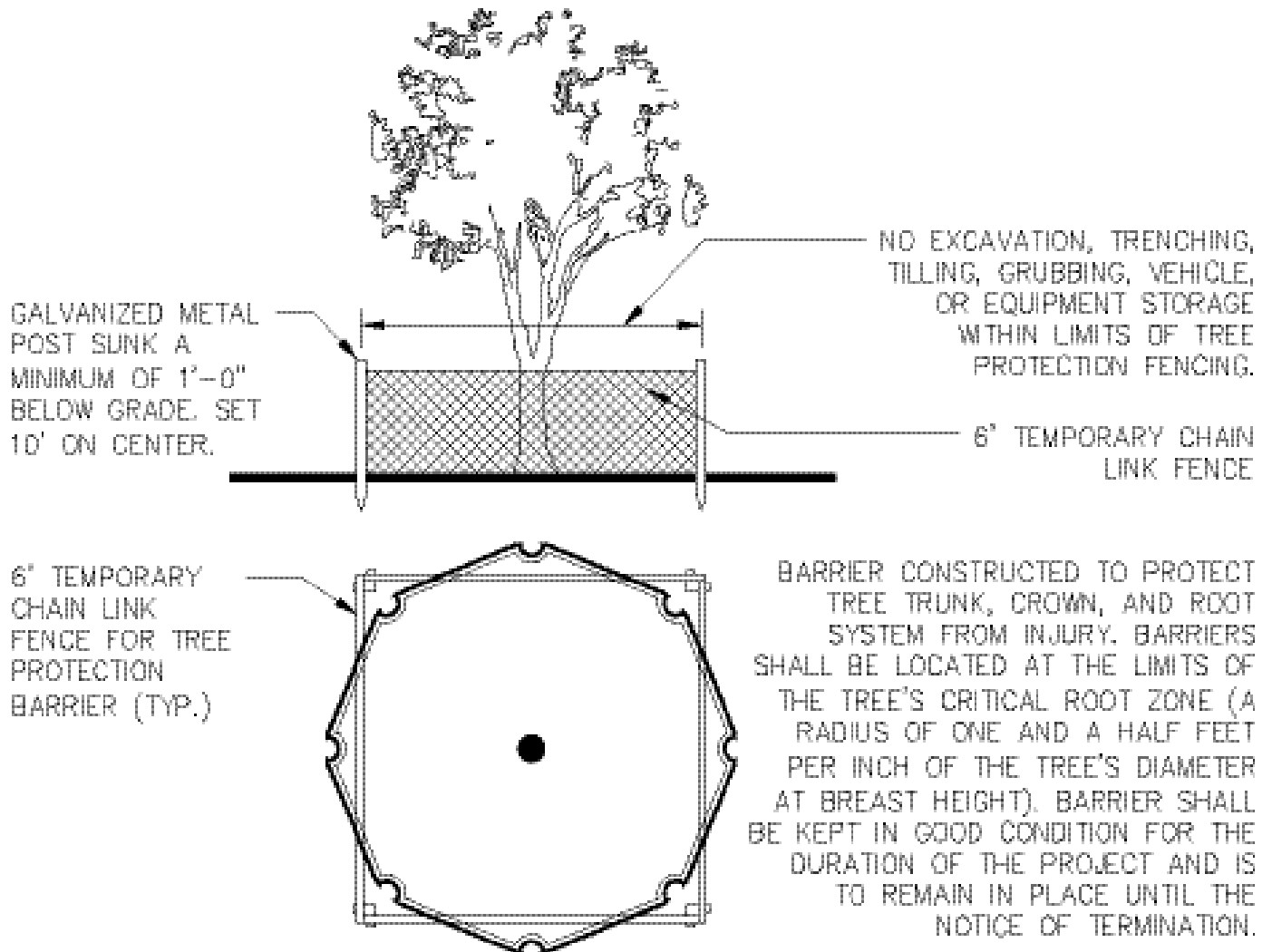

### FOR ADDED PROTECTION

- PROVIDE 4" DEEP ORGANIC MULCH OVER ANY UNPROTECTED ROOT ZONE.
- PROVIDE TEMPORARY IRRIGATION WHERE PRACTICAL AND FEASIBLE.

Figure 6-38.2

# Vegetated Waterway or Stormwater Conveyance Channel

Wt



## DEFINITION

A natural or constructed channel that is shaped or graded to required dimensions and established in suitable vegetation for the stable conveyance of runoff.

## PURPOSE

To dispose of runoff without causing damage either by erosion or by flooding.

## CONDITIONS

This standard applies to all sites where added channel capacity and/or stabilization is required to control erosion resulting from concentrated runoff, and where such control can be achieved by this practice alone or in combination with others.

## DESIGN CRITERIA

### Capacity

The minimum capacity shall be that required to convey the peak runoff expected from a 25-year, 24-hour storm, or the storm specified in Title 12-7-1 of the Official Code of Georgia Annotated. Peak runoff values used in determining the capacity requirements shall be as outlined in Appendix A or by other accepted methods.

The design of a waterway is based on the determination of channel dimensions that will carry the estimated flow without damage to the channel or its lining. Vegetative linings vary in their protective ability according to type and density. Therefore, safe velocities under various conditions are a matter for careful consideration.

## Velocity

In designing grassed waterways, care must be taken to ensure that the design velocity is well within the limits of permissible velocities given in Table 6-39.1. These values apply to uniform good stands of each type of cover.

## Cross Section

The minimum design capacity of a waterway receiving water from developing areas, diversions, or other tributary channels shall be that depth required to keep the design water surface elevation in the channel to prevent overflow.

The bottom width of waterways or outlets shall not exceed 50 feet unless multiple or divided waterways or other means are provided to control meandering of low flows within this limit. See Figure 6-39.1.

## Drainage

Tile or other suitable subsurface drainage measures shall be provided for sites having high water tables or seepage problems. Where there is base flow, a stone center or lined channel will be required. See Appendix C for rock riprap specifications.

## Stone Center

Stone center waterways shall be constructed as shown in Figure 6-39.2 and Table 6-39.3 and stabilized with riprap according to the specification Riprap - Appendix C.

Geotextiles should be used as an erosion control measure beneath the riprap center. The geotextile shall be specified in accordance with AASHTO M288-96 Section 7.5, *Permanent Erosion Control Requirements*.

## Vegetative Retardance Factor

The design of a vegetated waterway is more complicated than for a bare channel since the value for “n” varies where grass linings are used. Tests show that vegetation tends to bend and oscillate under the influence of velocity and depth of flow. Thus the retardance to flow varies as these factors change.

Five general retardance curves designated as A, B, C, D, and E have been developed for various cover conditions. The vegetated conditions under which the various retardance values apply in

Georgia are shown in Table 6-39.1. These cover classifications are based on tests in experimental channels when the covers were green and generally uniform.

“The Stormwater Conveyance Channel Design Sheets” shall be used to design grass-lined channels. These design sheets include the cross-sectional detail that shall be included on the erosion and sediment control plan.

If a stone center waterway is selected, it shall be designed according to Tables 6-39.2 and 6-39.3. Cross-sectional details on the erosion and sediment control plan shall include all information noted in Figure 6-39.2, including the maximum stone size of the rock to be used.

An example of how to design a grass-lined channel with a parabolic cross-section is provided on p. 6-288.

## CONSTRUCTION SPECIFICATIONS

1. All trees, brush, stumps, obstructions, and other objectionable material, shall be removed and disposed of so as not to interfere with the proper functioning of the waterway.
2. The waterway or outlet shall be excavated or shaped to line, grade, and cross section as required to meet the criteria specified herein. It will be free of bank projections or other irregularities that will impede normal flow. If the channel must have erosion protection other than vegetation, the lining shall not compromise the capacity of the emergency spillway, i.e. the channel shall be over-excavated so that the lining will be flush with the slope surface.
3. Fills shall be compacted as needed to prevent unequal settlement that would cause damage in the completed waterway.
4. All earth removed and not needed in construction shall be spread or disposed of so that it will not interfere with waterway functioning.
5. Stabilization

Applicable vegetative standards shall be followed for time of seeding, sprigging or sodding,

liming and fertilizing, and site and seedbed preparation.

Erosion control blankets or matting or sod shall be used to aid in the establishment of vegetation. Installation methods should follow manufacturer recommendations. Refer to specifications **Ds4 - Disturbed Area Stabilization (With Sodding)** and **Ss - Slope Stabilization**.

Mulching shall be a requirement for all seeded or sprigged channels.

Temporary protection during establishment should be provided when conditions permit through temporary diversions or other means to dispose of water.

**Table 6-39.1.  
Permissible Velocities and Retardances for Vegetated and Rock-Lined Waterways**

VEGETATIVE COVER TYPE	GOOD STAND				MAXIMUM PERMISSIBLE VELOCITY, $V_1$ , FEET PER SECOND
	FOR CAPACITY AND $V_2$		FOR STABILITY AND $V_1$		
	RETARDANCE	PLANT HT. NOT MOWED	RETARDANCE	PLANT HT. NOT MOWED	
BERMUDAGRASS	B	12"	D	2-6"	5
BAHIA	C	6-12"	D	2-6"	4
TALL FESCUE GRASS MIXTURES <sup>1</sup>	B	18"	D	6"	4
SERICEA LESPEDEZA WEEPING LOVEGRASS	B	19"	D	2-6"	3
STONE CENTER	RIPRAP STONE SIZE CAN BE DETERMINED IN APPENDIX C.				

<sup>1</sup> Mixtures of Tall Fescue, Bahia, and or Bremuda.

NOTE: For planting instructions refer to Disturbed Area Stabilization (with Permanent Vegetation) Ds3.



# TYPICAL WATERWAY CROSS SECTION

## PARABOLIC CROSS SECTION

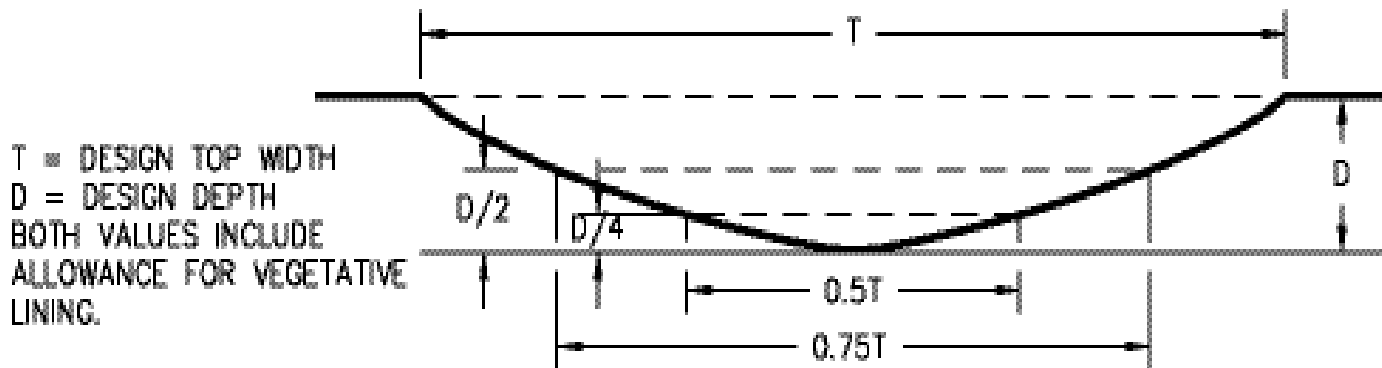

## TRAPEZOIDAL CROSS SECTION

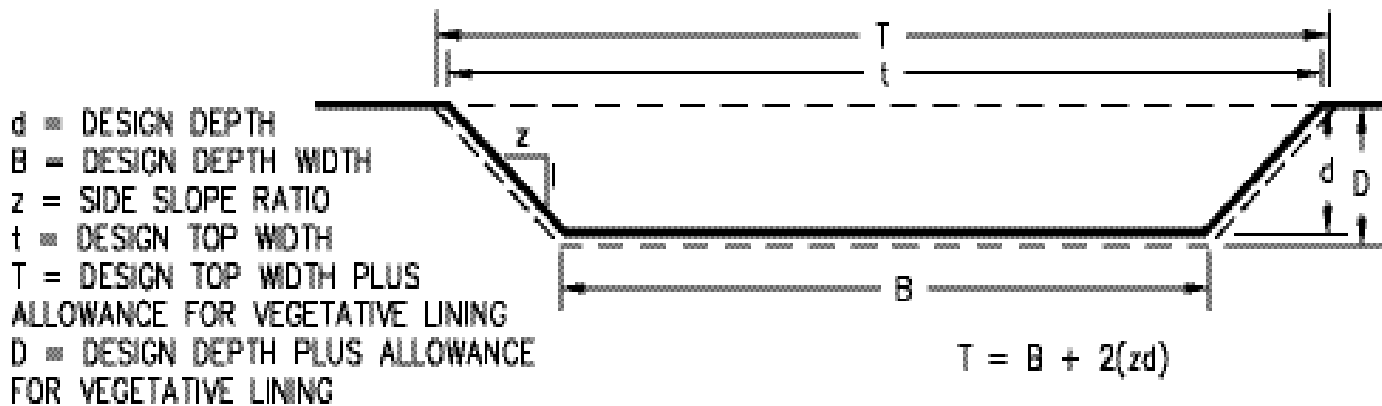
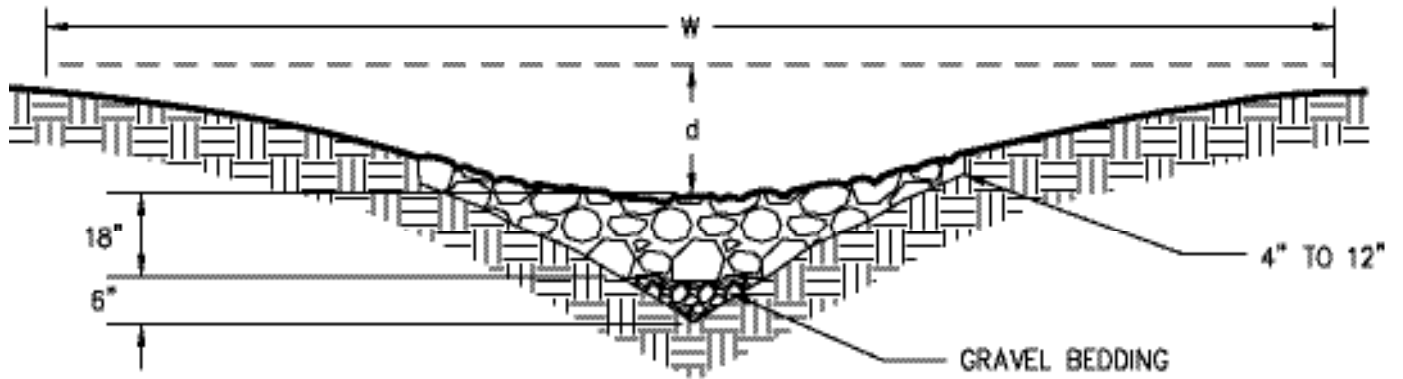

Figure 6-39.1

WATERWAY WITH STONE CENTER DRAIN AND  
V-SECTION SHAPED BY MOTOR GRADER



WATERWAY WITH STONE CENTER DRAIN AND  
ROUNDED SECTION SHAPED BY BULLDOZER

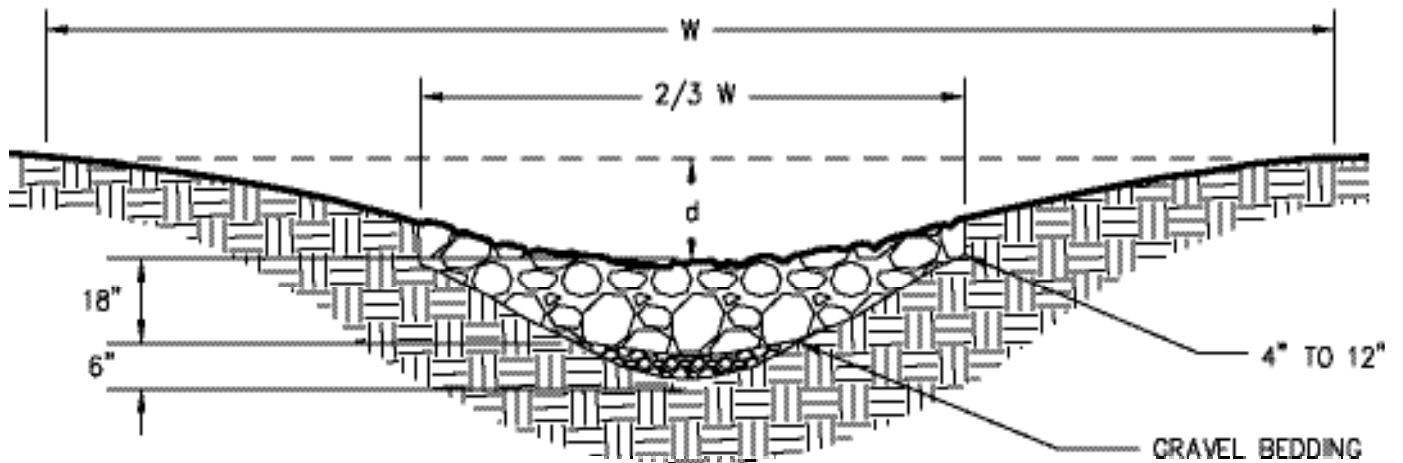
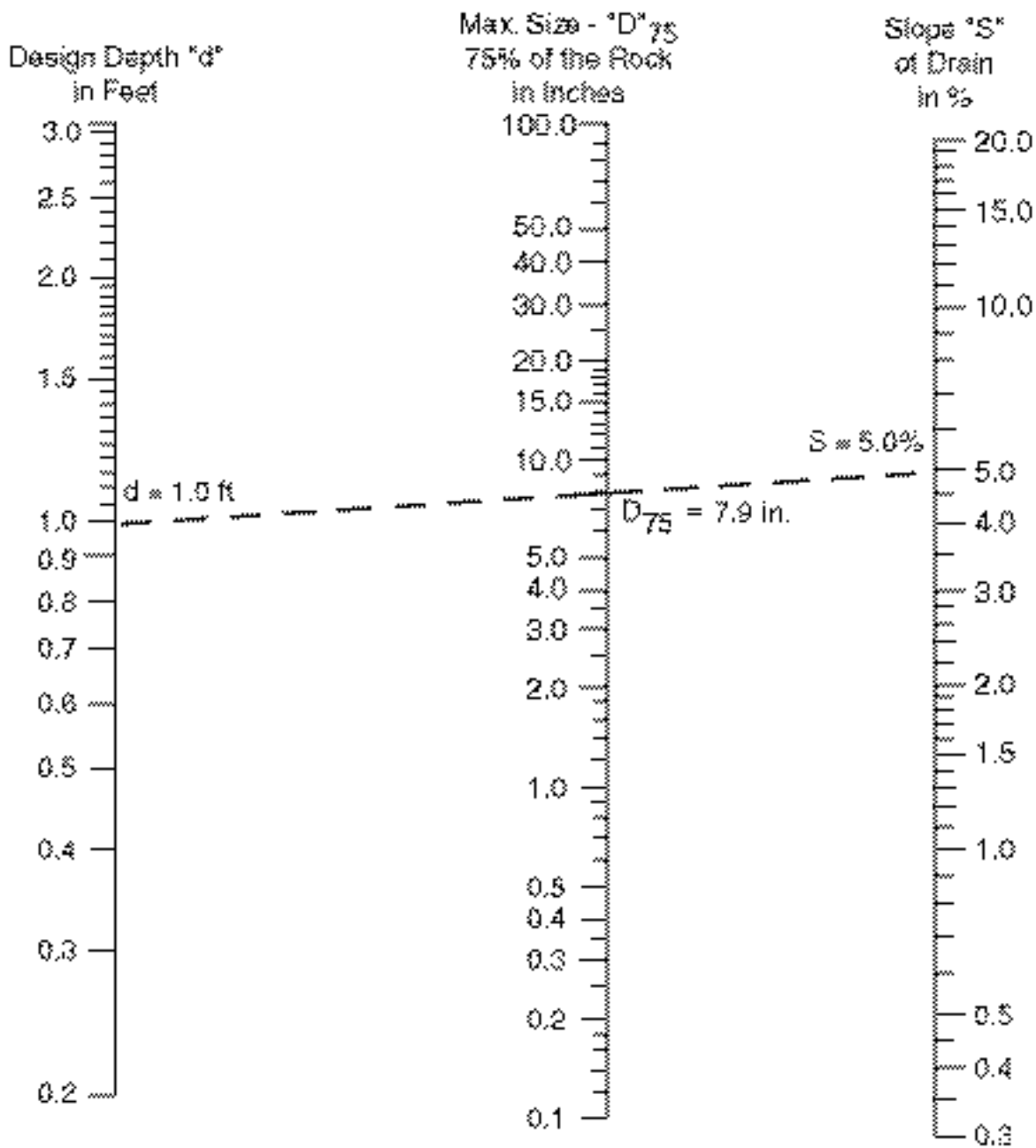

Figure 6-39.2 - Waterway With Stone Center

Table 6-39.2 Velocity, Top Width and Depth for Parabolic Stone Center Waterways

Grade	6 Percent		8 Percent		10 Percent		12 Percent		15 Percent	
V	8.0	10	8.0	10	8.0	10	8.0	10	8.0	10
D	1.3	1.6	1.1	1.3	1.0	1.2	0.9	1.1	0.8	0.9
Q										
Top Widths										
20							5			5
25					5		6			6
30			5		6		7			7
35			6		7		8	5	8	6
40	6		7		8		5	9	6	10
45	7		8		9		6	10	6	11
50	7		9		6	10	7	11	7	12
55	8		9		6	11	7	12	8	13
60	9		10		7	12	8	13	8	14
65	9		11		7	12	9	14	9	16
70	10	7	12		8	19	9	15	10	17
75	11	7	13		9	14	10	16	10	18
80	12	8	14		9	15	10	18	11	19
90	13	9	15		10	17	12	20	13	21
100	14	10	17		11	19	13	22	14	24
110	16	11	19		13	21	14	24	15	26
120	17	11	21		14	23	16	26	17	29
130	19	12	22		15	25	17	29	18	31
140	20	13	24		16	27	18	31	19	33
150	22	14	26		17	29	20	33	21	36
160	23	15	27		18	31	21	35	22	38
170	25	16	29		19	33	22	37	24	40
180	26	17	31		20	34	23	39	25	43
190	27	18	32		22	36	25	42	26	45
200	29	19	34		23	38	26	44	28	47
220	32	21	38		25	42	29	48	31	52
240	35	23	41		27	46	31	53	33	57
280	38	25	44		30	50	34	57	36	62
280	40	27	48		32	54	36	61	39	67
300	43	29	51		34	57	39	66	42	71



**EXAMPLE:** "d" = 1.0 Feet "S" = 5%

Place straight edge at "d" value in Design Depth column and at "S" value in Slope column. Read rock size in middle column 7.9 inches. Say 8 inches.

**FOR DESIGN:**

25% of the rock by volume should be in sizes of 8 inches or slightly larger. The remaining 75% or less should be of well graded material, smaller than 8 inches, including sufficient sands and gravels to fill the voids between the larger rock.

**Table 6-39.3 - Determination of Rock Size For Stone Center Waterway**

# STORMWATER CONVEYANCE CHANNEL DESIGN SHEET

## Vegetated Parabolic Channel

### EXAMPLE

Computed by \_\_\_\_\_ Date \_\_\_\_\_  
Checked by \_\_\_\_\_ Date \_\_\_\_\_

Project Name \_\_\_\_\_

1. Compute peak rate of runoff for 25-year, 24-hour storm.  
 $Q_{25} = 55$  cfs
2. Determine grade of channel.  
Grade = 6%
3. Determine which vegetative cover will be used. Refer to Ds3 - Disturbed Area Stabilization (Using Permanent Vegetation).  
Vegetative cover = Bermudagrass
4. Determine retardances and permissible velocities for channel using Table 6-27.1.  
The retardance class for capacity (unmowed vegetation) is B.  
The retardance class for stability (mowed vegetation) is D.  
Maximum permissible velocity,  $V_1$ , is 5 fps.
5. Determine dimensions of the parabolic channel. Use Table 6-28.1, for retardances "D" and "B".  
For a grade of 6% and a  $Q_{25}$  of 55 cfs,  
Top width,  $T = 29.1$  ft (includes allowance for vegetative lining)  
Depth,  $D = 1.0$  ft (includes allowance for vegetative lining)  
Velocity for unmowed vegetation,  $V_2 = 2.8$  fps.

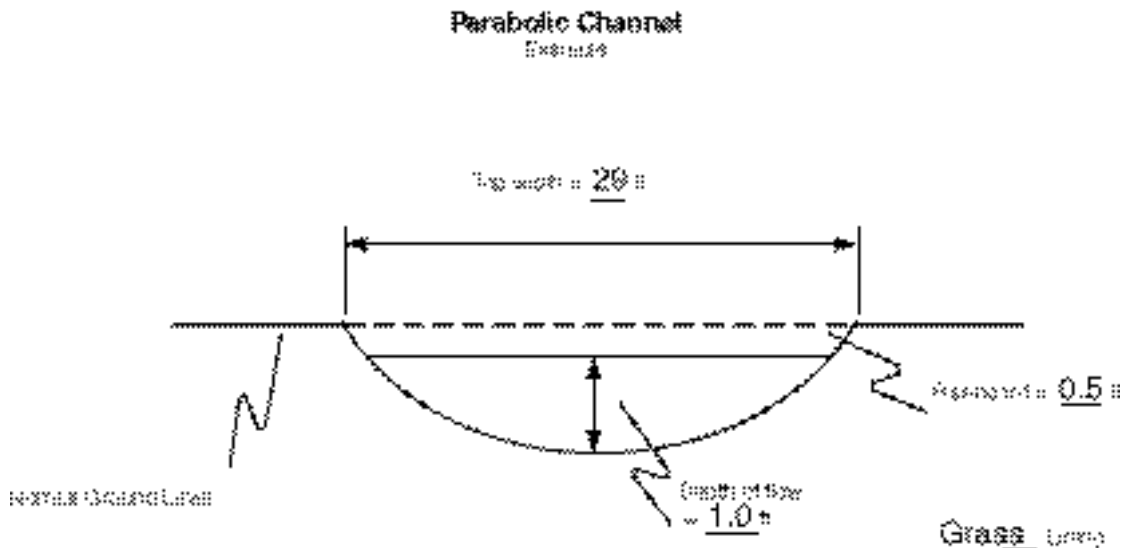

# STORMWATER CONVEYANCE CHANNEL DESIGN SHEET

## Vegetated Parabolic Channel

Computed by \_\_\_\_\_ Date \_\_\_\_\_

Checked by \_\_\_\_\_ Date \_\_\_\_\_

Project Name \_\_\_\_\_

1. Compute peak rate of runoff for 25-year, 24-hour storm.  
 $Q_{25} =$  \_\_\_\_\_ cfs
2. Determine grade of channel.  
 Grade = \_\_\_\_\_ %
3. Determine which vegetative cover will be used. Refer to Ds3 - Disturbed Area Stabilization (Using Permanent Vegetation).  
 Vegetative cover = \_\_\_\_\_
4. Determine retardances and permissible velocities for channel using Table 6-27.1.  
 The retardance class for capacity (unmowed vegetation) is \_\_\_\_\_.  
 The retardance class for stability (mowed vegetation) is \_\_\_\_\_.  
 Maximum permissible velocity,  $V_1$ , is \_\_\_\_\_ fps.
5. Determine dimensions of the parabolic channel. Use Table 6-28.1 for retardances "D" and "B". Use Table 6-28.2 for retardance "D" and "C".  
 For a grade of \_\_\_\_\_ % and a  $Q_{25}$  of \_\_\_\_\_ cfs,  
 Top width,  $T =$  \_\_\_\_\_ ft (includes allowance for vegetative lining)  
 Depth,  $D =$  \_\_\_\_\_ ft (includes allowance for vegetative lining)  
 Velocity for unmowed vegetation,  $V_2 =$  \_\_\_\_\_ fps.

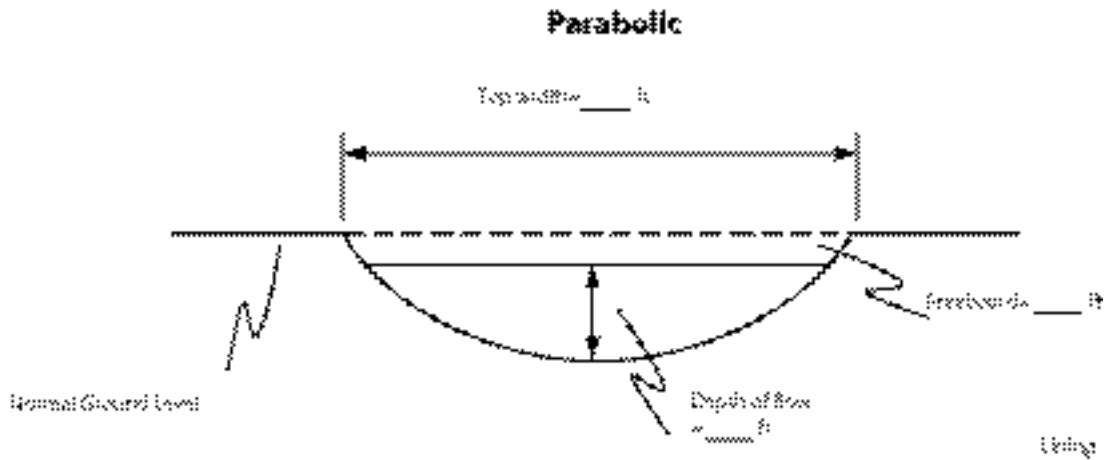

# STORMWATER CONVEYANCE CHANNEL DESIGN SHEET

## Vegetated Trapezoidal or Triangular Channel

Computed by \_\_\_\_\_ Date \_\_\_\_\_

Checked by \_\_\_\_\_ Date \_\_\_\_\_

Project Name \_\_\_\_\_

1. Compute peak rate of runoff for 25-year, 24-hour storm.  
 $Q_{25} =$  \_\_\_\_\_ cfs
2. Determine grade of channel.  
 Grade = \_\_\_\_\_ %
3. Determine which vegetative cover will be used. Refer to Ds3 - Disturbed Area Stabilization (Using Permanent Vegetation).  
 Vegetative cover = \_\_\_\_\_
4. Determine retardances and permissible velocities for channel using Table 6-27.1.  
 The retardance class for capacity is \_\_\_\_\_ and the unmowed plant height is \_\_\_\_\_ in.  
 The retardance class for stability is \_\_\_\_\_ and the mowed plant height is \_\_\_\_\_ in.  
 Maximum permissible velocity,  $V_1$ , is \_\_\_\_\_ fps.
5. Determine dimensions of the channel. Use Table 6-28.3 for retardance "D". Use Table 6-28.4 for retardance "C".  
 For a grade of \_\_\_\_\_ % and  $Q_{25}$  of \_\_\_\_\_ cfs,  
 Side slopes (z:1) = \_\_\_\_\_  
 Bottom width, B = \_\_\_\_\_ ft (0 for triangular channel)  
 Design depth, d = \_\_\_\_\_ ft  
 Area of channel, A = \_\_\_\_\_ sf.
6. Calculate the constructed depth of the channel.  
 Constructed depth, D = Design depth, d + Unmowed plant height  
 Constructed depth, D = \_\_\_\_\_ ft + \_\_\_\_\_ ft  
 Constructed depth, D = \_\_\_\_\_ ft
7. Calculate the top width of the channel.  
 Top width, T = Bottom width + 2(Side slope \* design depth)  
 Top width, T = B + 2(z\*d)  
 Top width, T = \_\_\_\_\_ ft + 2(\_\_\_\_\_ \* \_\_\_\_\_ ft)  
 Top width, T = \_\_\_\_\_ ft

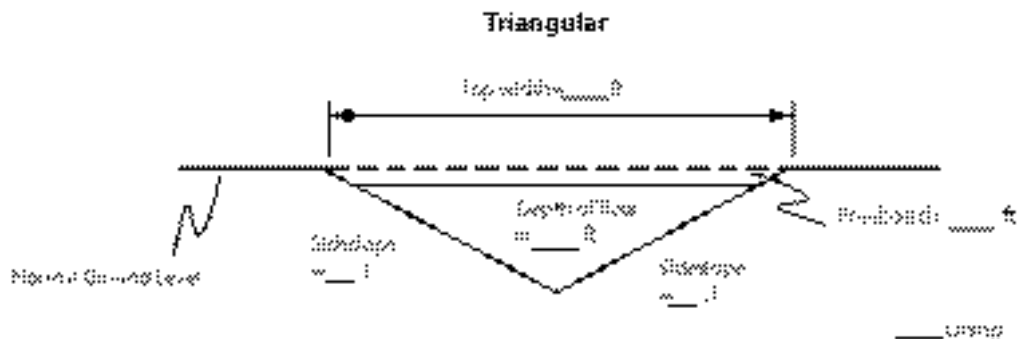
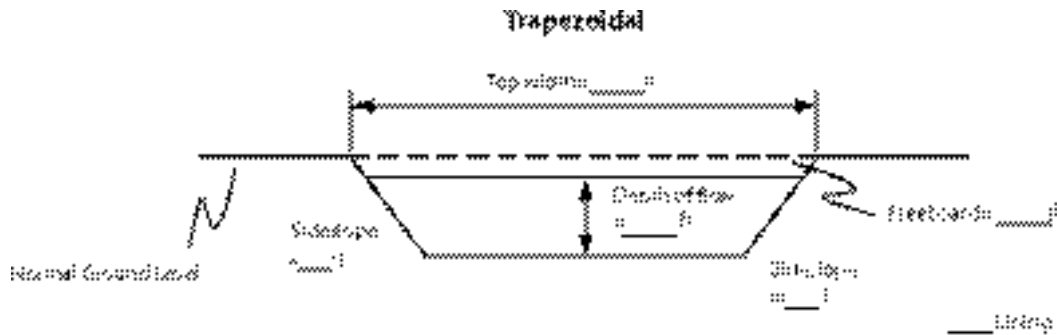

TO BE SUBMITTED WITH/ON  
THE EROSION, SEDIMENTATION AND POLLUTION CONTROL PLAN

GRASS-LINED CHANNEL

1. Stormwater Conveyance Channel Design Sheet for the appropriate channel shape.
2. Cross-sectional detail of the channel (include with Design Sheet and show on E&SC Plan).

STONE CENTER CHANNEL

1. Cross-sectional detail of the channel on the E&SC Plan.





**SECTION IV: TABLES FOR DESIGN  
OF STORMWATER  
CONVEYANCE PRACTICES**

Table 6-39.1. Design Chart for Parabolic Vegetated Diversion, Waterway or Stormwater Conveyance  
 V1 FOR RETARDANCE "D", TOP WIDTH (T), DEPTH (D), AND V2 FOR RETARDANCE "B"

Grade 0.25 Percent

Q CFS	V1-2.0		V1-2.5		V1-3.0		V1-3.5		V1-4.0		V1-4.5		V1-5.0		V1-5.5		V1-6.0	
	T	D	T	D	T	D	T	D	T	D	T	D	T	D	T	D	T	D
5																		
10																		
15																		
20																		
25	11.0	3.2	1.1															
30	13.8	3.0	1.1															
35	16.4	2.9	1.1															
40	19.0	2.8	1.1															
45	21.5	2.8	1.1	11.9	3.7	1.5												
50	24.0	2.8	1.1	14.1	3.4	1.5												
55	26.5	2.8	1.1	15.8	3.3	1.6												
60	29.0	2.8	1.1	17.5	3.3	1.6												
65	31.5	2.7	1.1	19.2	3.2	1.6	11.8	4.4	1.9									
70	34.0	2.7	1.1	20.8	3.2	1.6	13.7	4.0	1.9									
75	37.0	2.7	1.1	22.4	3.2	1.6	15.3	3.8	1.9									
80	39.4	2.7	1.1	24.1	3.2	1.6	16.6	3.7	1.9									
85	41.9	2.7	1.1	25.7	3.1	1.6	17.9	3.7	1.9									
90	44.3	2.7	1.1	27.2	3.1	1.6	19.1	3.6	1.9									
95	46.7	2.7	1.1	28.8	3.1	1.6	20.3	3.6	2.0									
100	49.2	2.7	1.1	30.4	3.1	1.6	21.5	3.6	2.0									
105	51.6	2.7	1.1	32.0	3.1	1.6	22.7	3.5	2.0									
110	54.1	2.7	1.1	33.6	3.1	1.6	23.9	3.5	2.0	14.4	4.8	2.4						
115	56.5	2.7	1.1	35.1	3.1	1.6	25.1	3.5	2.0	15.7	4.6	2.4						
120	59.0	2.7	1.1	36.7	3.1	1.6	26.2	3.5	2.0	17.0	4.4	2.4						
125	61.4	2.7	1.1	38.3	3.1	1.6	27.3	3.5	2.0	17.9	4.3	2.4						
130	63.9	2.7	1.1	39.7	3.1	1.6	28.5	3.4	2.0	18.8	4.3	2.4						
135	66.3	2.7	1.1	41.3	3.1	1.6	29.7	3.4	2.0	19.7	4.2	2.4						
140	68.8	2.7	1.1	43.4	3.0	1.6	30.8	3.4	2.0	20.6	4.2	2.4						
145	71.2	2.7	1.1	44.9	3.0	1.6	32.0	3.4	2.0	21.5	4.1	2.4						
150	73.7	2.7	1.1	46.5	3.0	1.6	33.1	3.4	2.0	22.4	4.1	2.5						

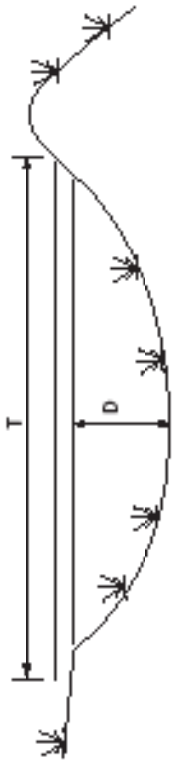

RETARDANCE "B" AND "D"

NOTE: Width and Depth dimensions are in feet; Velocity measurements are in feet per second;  
 Depth "D" does not include allowance for freeboard or settlement.



Table 6-39.1. Design Chart for Parabolic Vegetated Diversion, Waterway or Stormwater Conveyance (Continued)  
 V1 FOR RETARDANCE "D", TOP WIDTH (T), DEPTH (D), AND V2 FOR RETARDANCE "T"  
 Grade 0.75 Percent

Q CFS	V1-2.0		V1-2.5		V1-3.0		V1-3.5		V1-4.0		V1-4.5		V1-5.0		V1-5.5		V1-6.0					
	T	D	T	D	T	D	T	D	T	D	T	D	T	D	T	D	T	D				
5																						
10	8.3	1.9	1.0																			
15	12.9	1.8	1.0	8.4	2.1	1.3																
20	17.4	1.7	1.0	11.6	2.0	1.3	7.2	2.6	1.6													
25	22.2	1.7	1.0	14.8	1.9	1.3	10.0	2.2	1.7													
30	26.6	1.7	1.0	17.9	1.9	1.3	12.3	2.1	1.7	7.7	2.9	2.0										
35	31.0	1.7	1.0	20.9	1.9	1.4	14.5	2.1	1.7	10.0	2.5	2.1										
40	35.4	1.7	1.0	23.9	1.9	1.4	16.7	2.1	1.7	11.8	2.4	2.1										
45	39.8	1.7	1.0	27.3	1.8	1.3	18.9	2.1	1.7	13.5	2.3	2.2	8.9	3.0	2.6							
50	44.2	1.7	1.0	30.3	1.8	1.3	21.1	2.0	1.7	15.1	2.3	2.2	10.7	2.7	2.6							
55	48.7	1.7	1.0	33.3	1.8	1.3	23.3	2.0	1.7	16.7	2.3	2.2	12.1	2.6	2.6							
60	53.1	1.7	1.0	36.3	1.8	1.4	25.5	2.0	1.7	18.4	2.3	2.2	13.4	2.6	2.6							
65	57.5	1.7	1.0	39.3	1.8	1.4	28.0	2.0	1.7	20.0	2.2	2.2	14.7	2.5	2.6	9.5	3.3	3.1				
70	61.9	1.7	1.0	42.3	1.8	1.4	30.2	2.0	1.7	21.6	2.2	2.2	15.9	2.5	2.6	11.2	3.0	3.1				
75	66.3	1.7	1.0	45.3	1.8	1.4	32.3	2.0	1.7	23.2	2.2	2.2	17.2	2.5	2.6	12.3	2.9	3.1				
80	70.7	1.7	1.0	48.3	1.8	1.4	34.4	2.0	1.7	24.8	2.2	2.2	18.4	2.5	2.6	13.3	2.9	3.1				
85	75.2	1.7	1.0	51.4	1.8	1.4	36.6	2.0	1.7	26.3	2.2	2.2	19.6	2.5	2.6	14.3	2.8	3.1	10.2	3.6	3.4	
90	79.6	1.7	1.0	54.4	1.8	1.4	38.7	2.0	1.7	27.9	2.2	2.2	20.8	2.4	2.7	15.3	2.8	3.1	11.4	3.4	3.5	
95	84.0	1.7	1.0	57.4	1.8	1.4	40.9	2.0	1.7	29.5	2.2	2.2	22.0	2.4	2.7	16.3	2.8	3.1	12.7	3.2	3.5	
100	88.4	1.7	1.0	60.4	1.8	1.4	43.0	2.0	1.7	31.4	2.2	2.2	23.2	2.4	2.7	17.2	2.8	3.1	13.5	3.2	3.5	
105	92.8	1.7	1.0	63.4	1.8	1.4	45.1	2.0	1.7	33.0	2.2	2.2	24.4	2.4	2.7	18.2	2.7	3.2	14.4	3.1	3.5	
110	97.2	1.7	1.0	66.4	1.8	1.4	47.3	2.0	1.7	34.6	2.2	2.2	25.6	2.4	2.7	19.1	2.7	3.2	15.2	3.1	3.5	
115	101.7	1.7	1.0	69.4	1.8	1.4	49.4	2.0	1.7	36.1	2.2	2.2	26.8	2.4	2.7	20.0	2.7	3.2	16.0	3.0	3.5	
120	106.1	1.7	1.0	72.5	1.8	1.4	51.6	2.0	1.7	37.7	2.2	2.2	28.0	2.4	2.7	21.0	2.7	3.2	16.8	3.0	3.5	
125	110.5	1.7	1.0	75.5	1.8	1.4	53.7	2.0	1.7	39.2	2.2	2.2	29.2	2.4	2.7	21.9	2.7	3.2	17.6	3.0	3.5	
130	114.9	1.7	1.0	78.5	1.8	1.4	55.8	2.0	1.7	40.8	2.2	2.2	30.4	2.4	2.7	22.8	2.7	3.2	18.4	3.0	3.6	
135	119.3	1.7	1.0	81.5	1.8	1.4	58.0	2.0	1.7	42.4	2.2	2.2	31.6	2.4	2.7	23.8	2.7	3.2	19.1	2.9	3.6	
140	123.7	1.7	1.0	84.5	1.8	1.4	60.1	2.0	1.7	43.9	2.2	2.2	32.8	2.4	2.7	24.7	2.7	3.2	19.9	2.9	3.6	
145	128.2	1.7	1.0	87.5	1.8	1.4	62.3	2.0	1.7	45.5	2.2	2.2	34.5	2.4	2.7	25.6	2.7	3.2	20.7	2.9	3.6	
150	132.6	1.7	1.0	90.6	1.8	1.4	64.4	2.0	1.7	47.1	2.2	2.2	36.7	2.4	2.7	26.5	2.6	3.2	21.5	2.9	3.6	

RETARDANCE "D" AND "T"

NOTE: Width and Depth dimensions are in feet; Velocity measurements are in feet per second; Depth "D" does not include allowance for freeboard or settlement.

Table 6-39.1. Design Chart for Parabolic Vegetated Diversion, Waterway or Stormwater Conveyance (Continued)  
 V1 FOR RETARDANCE T1, TOP WIDTH (T), DEPTH (D), AND V2 FOR RETARDANCE T2

Grade 1.00 Percent

Q CFR	V1-2.0		V1-2.5		V1-3.0		V1-3.5		V1-4.0		V1-4.5		V1-5.0		V1-5.5		V1-6.0										
	T	D	T	D	T	D	T	D	T	D	T	D	T	D	T	D	T	D									
5																											
10	9.7	1.6	1.0	6.2	2.0	1.2																					
15	14.8	1.5	1.0	10.2	1.7	1.3	6.5	2.2	1.5																		
20	20.2	1.5	1.0	13.8	1.7	1.3	9.6	1.9	1.6																		
25	25.1	1.5	1.0	17.4	1.7	1.3	12.2	1.9	1.6	8.5	2.2	2.0															
30	30.1	1.5	1.0	21.0	1.6	1.3	14.9	1.8	1.7	10.6	2.1	2.1															
35	35.1	1.5	1.0	24.7	1.6	1.3	17.5	1.8	1.7	12.6	2.0	2.1	8.9	2.4	2.5												
40	40.1	1.5	1.0	28.2	1.6	1.3	20.0	1.8	1.7	14.5	2.0	2.1	10.5	2.3	2.5												
45	45.1	1.5	1.0	31.7	1.6	1.3	22.5	1.8	1.7	16.4	2.0	2.1	12.1	2.2	2.5	8.2	2.8	2.9									
50	50.2	1.5	1.0	35.2	1.6	1.3	25.4	1.8	1.7	18.3	2.0	2.1	13.6	2.2	2.5	10.0	2.6	2.9									
55	55.2	1.5	1.0	38.8	1.6	1.3	27.9	1.8	1.7	20.3	1.9	2.1	15.1	2.2	2.5	11.2	2.5	3.0									
60	60.2	1.5	1.0	42.3	1.6	1.3	30.4	1.8	1.7	22.2	1.9	2.1	16.6	2.1	2.5	12.4	2.4	3.0									
65	65.2	1.5	1.0	45.8	1.6	1.3	32.9	1.8	1.7	24.0	1.9	2.1	18.0	2.1	2.5	13.6	2.4	3.0	8.9	3.1	3.5						
70	70.2	1.5	1.0	49.3	1.6	1.3	35.5	1.8	1.7	25.9	1.9	2.1	19.5	2.1	2.6	14.8	2.4	3.0	10.6	2.8	3.5						
75	75.2	1.5	1.0	52.8	1.6	1.3	38.0	1.8	1.7	28.2	1.9	2.1	20.9	2.1	2.6	16.0	2.3	3.0	11.5	2.8	3.5						
80	80.2	1.5	1.0	56.3	1.6	1.3	40.5	1.8	1.7	30.0	1.9	2.1	22.3	2.1	2.6	17.1	2.3	3.0	12.5	2.7	3.5						
85	85.2	1.5	1.0	59.8	1.6	1.3	43.0	1.8	1.7	31.9	1.9	2.1	23.7	2.1	2.6	18.3	2.3	3.0	13.5	2.7	3.6	9.8	3.3	3.9			
90	90.2	1.5	1.0	63.3	1.6	1.3	45.6	1.8	1.7	33.6	1.9	2.1	25.2	2.1	2.6	19.4	2.3	3.1	14.4	2.6	3.6	10.9	3.1	3.9			
95	95.2	1.5	1.0	66.9	1.6	1.3	48.1	1.8	1.7	35.5	1.9	2.1	26.6	2.1	2.6	20.5	2.3	3.1	15.3	2.6	3.6	12.0	3.0	3.9			
100	100.2	1.5	1.0	70.4	1.6	1.3	50.6	1.8	1.7	37.4	1.9	2.1	28.0	2.1	2.6	21.6	2.3	3.1	16.2	2.6	3.6	12.9	2.9	4.0			
105	105.3	1.5	1.0	73.9	1.6	1.3	53.1	1.8	1.7	39.2	1.9	2.1	29.8	2.1	2.6	22.8	2.3	3.1	17.1	2.6	3.6	13.7	2.9	4.0	10.8	3.4	4.3
110	110.3	1.5	1.0	77.4	1.6	1.3	55.7	1.8	1.7	41.1	1.9	2.1	31.3	2.1	2.6	23.9	2.3	3.1	18.0	2.6	3.6	14.4	2.9	4.0	12.0	3.2	4.3
115	115.3	1.5	1.0	80.9	1.6	1.3	58.2	1.8	1.7	42.9	1.9	2.1	32.7	2.1	2.6	25.0	2.3	3.1	18.9	2.5	3.6	15.2	2.8	4.0	12.7	3.2	4.3
120	120.3	1.5	1.0	84.4	1.6	1.3	60.7	1.8	1.7	44.8	1.9	2.1	34.1	2.1	2.6	26.1	2.2	3.1	19.7	2.5	3.6	16.0	2.8	4.0	13.4	3.1	4.3
125	125.3	1.5	1.0	88.0	1.6	1.3	63.2	1.8	1.7	46.7	1.9	2.1	35.5	2.1	2.6	27.2	2.2	3.1	20.6	2.5	3.6	16.8	2.8	4.0	14.1	3.1	4.3
130	130.3	1.5	1.0	91.5	1.6	1.3	65.8	1.8	1.7	48.5	1.9	2.1	36.9	2.1	2.6	28.4	2.2	3.1	21.5	2.5	3.6	17.4	2.8	4.0	14.8	3.1	4.3
135	135.3	1.5	1.0	95.0	1.6	1.3	68.3	1.8	1.7	50.4	1.9	2.1	38.3	2.1	2.6	29.5	2.2	3.1	22.4	2.5	3.6	18.2	2.8	4.0	15.5	3.0	4.3
140	140.3	1.5	1.0	98.5	1.6	1.3	70.8	1.8	1.7	52.2	1.9	2.1	39.7	2.0	2.6	30.6	2.2	3.1	23.2	2.5	3.6	18.9	2.7	4.0	16.1	3.0	4.4
145	145.3	1.5	1.0	102.0	1.6	1.3	73.3	1.8	1.7	54.1	1.9	2.1	41.1	2.0	2.6	32.1	2.2	3.0	24.1	2.5	3.6	19.7	2.7	4.0	16.8	3.0	4.4
150	150.3	1.5	1.0	105.5	1.6	1.3	75.9	1.8	1.7	56.0	1.9	2.1	42.5	2.0	2.6	33.2	2.2	3.0	25.0	2.5	3.6	20.4	2.7	4.1	17.5	2.9	4.4

RETARDANCE T1 AND T2

NOTE: Width and Depth dimensions are in feet. Velocity measurements are in feet per second. Depth T1 does not include allowance for freeboard or settlement.

Table 6-39.1. Design Chart for Parabolic Vegetated Diversion, Wasteway or Stormwater Conveyance (Continued)  
 V1 FOR RETARDANCE 'D', TOP WIDTH (T), DEPTH (D), AND V2 FOR RETARDANCE 'B'

Grade 1.25 Percent

Q CFS	V1-2.0		V1-2.5		V1-3.0		V1-3.5		V1-4.0		V1-4.5		V1-5.0		V1-5.5		V1-6.0				
	T	D	T	D	T	D	T	D	T	D	T	D	T	D	T	D	T	D			
5	5.0	1.3	0.8																		
10	11.1	1.4	0.9	7.4	1.6	1.2															
15	16.9	1.4	1.0	11.6	1.5	1.3	8.1	1.8	1.6												
20	22.8	1.4	0.9	15.6	1.5	1.3	11.1	1.7	1.6	7.3	2.0	1.9									
25	28.4	1.4	1.0	19.9	1.5	1.3	14.1	1.7	1.6	10.1	1.9	2.0	6.8	2.4	2.3						
30	34.1	1.4	1.0	23.8	1.5	1.3	17.0	1.6	1.6	12.4	1.8	2.0	9.0	2.1	2.4						
35	39.8	1.4	1.0	27.8	1.5	1.3	19.8	1.6	1.6	14.6	1.8	2.0	10.8	2.0	2.4	7.4	2.5	2.8			
40	45.4	1.4	1.0	31.7	1.5	1.3	23.0	1.6	1.6	16.8	1.8	2.0	12.5	2.0	2.5	9.3	2.3	2.9			
45	51.1	1.4	1.0	35.6	1.5	1.3	25.8	1.6	1.6	19.0	1.8	2.0	14.2	1.9	2.5	10.7	2.2	2.9			
50	56.8	1.4	1.0	39.5	1.5	1.3	28.7	1.6	1.6	21.1	1.7	2.0	15.9	1.9	2.5	12.1	2.1	2.9	8.7	2.6	3.3
55	62.5	1.4	1.0	43.5	1.5	1.3	31.5	1.6	1.6	23.6	1.7	2.0	17.6	1.9	2.5	13.4	2.1	2.9	10.2	2.4	3.4
60	68.1	1.4	1.0	47.4	1.5	1.3	34.4	1.6	1.6	25.7	1.7	2.0	19.2	1.9	2.5	14.7	2.1	2.9	11.3	2.4	3.4
65	73.8	1.4	1.0	51.4	1.5	1.3	37.2	1.6	1.6	27.9	1.7	2.0	20.9	1.9	2.5	16.1	2.1	2.9	12.4	2.3	3.4
70	79.5	1.4	1.0	55.3	1.5	1.3	40.1	1.6	1.6	30.0	1.7	2.0	22.5	1.9	2.5	17.4	2.1	2.9	13.5	2.3	3.4
75	85.2	1.4	1.0	59.2	1.5	1.3	43.0	1.6	1.6	32.1	1.7	2.0	24.1	1.9	2.5	18.6	2.0	3.0	14.6	2.3	3.4
80	90.8	1.4	1.0	63.2	1.5	1.3	45.8	1.6	1.6	34.2	1.7	2.0	26.1	1.9	2.5	19.9	2.0	3.0	15.7	2.2	3.4
85	96.5	1.4	1.0	67.1	1.5	1.3	48.7	1.6	1.6	36.4	1.7	2.0	27.7	1.8	2.5	21.2	2.0	3.0	16.7	2.2	3.4
90	102.2	1.4	1.0	71.1	1.5	1.3	51.5	1.6	1.6	38.5	1.7	2.0	29.3	1.8	2.5	22.5	2.0	3.0	17.7	2.2	3.5
95	107.9	1.4	1.0	75.0	1.5	1.3	54.4	1.6	1.6	40.6	1.7	2.0	30.9	1.8	2.5	23.8	2.0	3.0	18.8	2.2	3.5
100	113.5	1.4	1.0	79.0	1.5	1.3	57.2	1.6	1.6	42.8	1.7	2.0	32.6	1.8	2.5	25.1	2.0	3.0	19.8	2.2	3.5
105	119.2	1.4	1.0	82.9	1.5	1.3	60.1	1.6	1.6	44.9	1.7	2.0	34.2	1.8	2.5	26.4	2.0	3.0	20.8	2.2	3.5
110	124.9	1.4	1.0	86.9	1.5	1.3	63.0	1.6	1.6	47.0	1.7	2.0	35.8	1.8	2.5	27.6	2.0	3.0	21.9	2.2	3.5
115	130.6	1.4	1.0	90.8	1.5	1.3	65.8	1.6	1.6	49.2	1.7	2.0	37.4	1.8	2.5	29.3	2.0	3.0	22.9	2.2	3.5
120	136.2	1.4	1.0	94.8	1.5	1.3	68.7	1.6	1.6	51.3	1.7	2.0	39.0	1.8	2.5	30.5	2.0	3.0	23.9	2.2	3.5
125	141.9	1.4	1.0	98.7	1.5	1.3	71.5	1.6	1.6	53.4	1.7	2.0	40.6	1.8	2.5	31.8	2.0	3.0	25.0	2.2	3.5
130	147.6	1.4	1.0	102.7	1.5	1.3	74.4	1.6	1.6	55.6	1.7	2.0	42.3	1.8	2.5	33.1	2.0	3.0	26.0	2.2	3.5
135	153.3	1.4	1.0	106.6	1.5	1.3	77.3	1.6	1.6	57.7	1.7	2.0	43.9	1.8	2.5	34.3	2.0	3.0	27.0	2.2	3.5
140	158.9	1.4	1.0	110.5	1.5	1.3	80.1	1.6	1.6	59.8	1.7	2.0	45.5	1.8	2.5	35.6	2.0	3.0	28.0	2.2	3.5
145	164.6	1.4	1.0	114.5	1.5	1.3	83.0	1.6	1.6	62.0	1.7	2.0	47.1	1.8	2.5	36.9	2.0	3.0	29.1	2.2	3.5
150	170.3	1.4	1.0	118.4	1.5	1.3	85.8	1.6	1.6	64.1	1.7	2.0	48.8	1.8	2.5	38.1	2.0	3.0	30.1	2.2	3.5

RETARDANCE "B" AND "B"

NOTE: Width and Depth dimensions are in feet. Velocity measurements are in feet per second.  
 Depth "D" does not include allowance for freeboard or settlement.

Table 6-39.1. Design Chart for Parabolic Vegetated Diversion, Waterway or Stormwater Conveyance (Continued)  
 V1 FOR RETARDANCE T1, TOP WIDTH (T), DEPTH (D), AND V2 FOR RETARDANCE T2

Grade 1.50 Percent

Q CFR	V1-2.0		V1-2.5		V1-3.0		V1-3.5		V1-4.0		V1-4.5		V1-5.0		V1-5.5		V1-6.0				
	T	D	T	D	T	D	T	D	T	D	T	D	T	D	T	D	T	D			
5	5.9	1.5	0.9																		
10	12.4	1.3	0.9	8.3	1.5	1.2	5.5	1.9	1.5												
15	18.9	1.3	0.9	12.8	1.4	1.2	9.1	1.6	1.6	6.2	1.9	1.9									
20	25.1	1.3	0.9	17.2	1.4	1.2	12.4	1.5	1.6	9.0	1.7	1.9	6.0	2.2	2.2						
25	31.4	1.3	0.9	21.8	1.4	1.2	15.6	1.5	1.6	11.5	1.7	2.0	8.4	1.9	2.4						
30	37.7	1.3	0.9	26.1	1.4	1.2	18.8	1.5	1.6	14.0	1.6	2.0	10.4	1.8	2.4	7.6	2.1	2.8			
35	43.9	1.3	0.9	30.4	1.4	1.2	22.2	1.5	1.6	16.4	1.6	2.0	12.3	1.8	2.4	9.2	2.0	2.8			
40	50.2	1.3	0.9	34.8	1.4	1.3	25.3	1.5	1.6	18.8	1.6	2.0	14.2	1.8	2.4	10.8	2.0	2.8	7.8	2.4	3.2
45	56.5	1.3	0.9	39.1	1.4	1.3	28.5	1.5	1.6	21.2	1.6	2.0	16.1	1.7	2.4	12.3	1.9	2.9	9.4	2.2	3.3
50	62.7	1.3	0.9	43.5	1.4	1.3	31.7	1.5	1.6	23.9	1.6	2.0	17.9	1.7	2.4	13.8	1.9	2.9	10.6	2.1	3.3
55	69.0	1.3	0.9	47.8	1.4	1.3	34.8	1.5	1.6	26.2	1.6	2.0	19.8	1.7	2.4	15.3	1.9	2.9	11.9	2.1	3.3
60	75.3	1.3	0.9	52.1	1.4	1.3	38.0	1.5	1.6	28.6	1.6	2.0	21.6	1.7	2.4	16.7	1.9	2.9	13.1	2.1	3.3
65	81.5	1.3	0.9	56.5	1.4	1.3	41.1	1.5	1.6	31.0	1.6	2.0	23.8	1.7	2.4	18.2	1.9	2.9	14.3	2.0	3.3
70	87.8	1.3	0.9	60.8	1.4	1.3	44.3	1.5	1.6	33.3	1.6	2.0	25.6	1.7	2.4	19.6	1.8	2.9	15.5	2.0	3.3
75	94.1	1.3	0.9	65.2	1.4	1.3	47.4	1.5	1.6	35.7	1.6	2.0	27.4	1.7	2.4	21.0	1.8	2.9	16.6	2.0	3.4
80	100.3	1.3	0.9	69.5	1.4	1.3	50.6	1.5	1.6	38.1	1.6	2.0	29.1	1.7	2.4	22.5	1.8	2.9	17.8	2.0	3.4
85	106.6	1.3	0.9	73.8	1.4	1.3	53.7	1.5	1.6	40.5	1.6	2.0	30.9	1.7	2.4	23.9	1.8	2.9	18.9	2.0	3.4
90	112.9	1.3	0.9	78.2	1.4	1.3	56.9	1.5	1.6	42.8	1.6	2.0	32.7	1.7	2.4	25.7	1.8	2.9	20.1	2.0	3.4
95	119.1	1.3	0.9	82.5	1.4	1.3	60.0	1.5	1.6	45.2	1.6	2.0	34.5	1.7	2.4	27.1	1.8	2.9	21.2	2.0	3.4
100	125.4	1.3	0.9	86.9	1.4	1.3	63.2	1.5	1.6	47.6	1.6	2.0	36.3	1.7	2.4	28.5	1.8	2.9	22.4	2.0	3.4
105	131.7	1.3	0.9	91.2	1.4	1.3	66.4	1.5	1.6	50.0	1.6	2.0	38.1	1.7	2.4	29.9	1.8	2.9	23.5	2.0	3.4
110	138.0	1.3	0.9	95.5	1.4	1.3	69.5	1.5	1.6	52.3	1.6	2.0	40.0	1.7	2.4	31.3	1.8	2.9	24.7	2.0	3.4
115	144.2	1.3	0.9	99.9	1.4	1.3	72.7	1.5	1.6	54.7	1.6	2.0	41.8	1.7	2.4	32.8	1.8	2.9	25.8	2.0	3.4
120	150.5	1.3	0.9	104.2	1.4	1.3	75.8	1.5	1.6	57.1	1.6	2.0	43.6	1.7	2.4	34.2	1.8	2.9	27.0	2.0	3.4
125	156.8	1.3	0.9	108.6	1.4	1.3	79.0	1.5	1.6	59.5	1.6	2.0	45.4	1.7	2.4	35.6	1.8	2.9	28.5	2.0	3.4
130	163.0	1.3	0.9	112.9	1.4	1.3	82.2	1.5	1.6	61.8	1.6	2.0	47.2	1.7	2.4	37.0	1.8	2.9	29.6	2.0	3.4
135	169.3	1.3	0.9	117.2	1.4	1.3	85.3	1.5	1.6	64.2	1.6	2.0	49.0	1.7	2.4	38.4	1.8	2.9	30.8	1.9	3.4
140	175.6	1.3	0.9	121.6	1.4	1.3	88.5	1.5	1.6	66.6	1.6	2.0	50.8	1.7	2.4	39.8	1.8	2.9	31.9	1.9	3.4
145	181.8	1.3	0.9	125.9	1.4	1.3	91.6	1.5	1.6	69.0	1.6	2.0	52.6	1.7	2.4	41.3	1.8	2.9	33.0	1.9	3.4
150	188.1	1.3	0.9	130.3	1.4	1.3	94.8	1.5	1.6	71.3	1.6	2.0	54.4	1.7	2.4	42.7	1.8	2.9	34.2	1.9	3.4

RETARDANCE T2 AND D2

NOTE: Width and Depth dimensions are in feet. Velocity measurements are in feet per second.  
 Depth T2 does not include allowance for freeboard or settlement.



Table 6-39.1. Design Chart for Parabolic Vegetated Diversion, Waterway or Stormwater Conveyance (Continued)  
 V1 FOR RETARDANCE T1, TOP WIDTH (T), DEPTH (D), AND V2 FOR RETARDANCE T2

Grade 1.50 Percent

Q CFR	V1-2.0		V1-2.5		V1-3.0		V1-3.5		V1-4.0		V1-4.5		V1-5.0		V1-5.5		V1-6.0				
	T	D	T	D	T	D	T	D	T	D	T	D	T	D	T	D	T	D			
5	5.9	1.5	0.9																		
10	12.4	1.3	0.9	8.3	1.5	1.2	5.5	1.9	1.5												
15	18.9	1.3	0.9	12.8	1.4	1.2	9.1	1.6	1.6	6.2	1.9	1.9									
20	25.1	1.3	0.9	17.2	1.4	1.2	12.4	1.5	1.6	9.0	1.7	1.9	6.0	2.2	2.2						
25	31.4	1.3	0.9	21.8	1.4	1.2	15.6	1.5	1.6	11.5	1.7	2.0	8.4	1.9	2.4						
30	37.7	1.3	0.9	26.1	1.4	1.2	18.8	1.5	1.6	14.0	1.6	2.0	10.4	1.8	2.4	7.6	2.1	2.8			
35	43.9	1.3	0.9	30.4	1.4	1.2	22.2	1.5	1.6	16.4	1.6	2.0	12.3	1.8	2.4	9.2	2.0	2.8			
40	50.2	1.3	0.9	34.8	1.4	1.3	25.3	1.5	1.6	18.8	1.6	2.0	14.2	1.8	2.4	10.8	2.0	2.8	7.8	2.4	3.2
45	56.5	1.3	0.9	39.1	1.4	1.3	28.5	1.5	1.6	21.2	1.6	2.0	16.1	1.7	2.4	12.3	1.9	2.9	9.4	2.2	3.3
50	62.7	1.3	0.9	43.5	1.4	1.3	31.7	1.5	1.6	23.9	1.6	2.0	17.9	1.7	2.4	13.8	1.9	2.9	10.6	2.1	3.3
55	69.0	1.3	0.9	47.8	1.4	1.3	34.8	1.5	1.6	26.2	1.6	2.0	19.8	1.7	2.4	15.3	1.9	2.9	11.9	2.1	3.3
60	75.3	1.3	0.9	52.1	1.4	1.3	38.0	1.5	1.6	28.6	1.6	2.0	21.6	1.7	2.4	16.7	1.9	2.9	13.1	2.1	3.3
65	81.5	1.3	0.9	56.5	1.4	1.3	41.1	1.5	1.6	31.0	1.6	2.0	23.8	1.7	2.4	18.2	1.9	2.9	14.3	2.0	3.3
70	87.8	1.3	0.9	60.8	1.4	1.3	44.3	1.5	1.6	33.3	1.6	2.0	25.6	1.7	2.4	19.6	1.8	2.9	15.5	2.0	3.3
75	94.1	1.3	0.9	65.2	1.4	1.3	47.4	1.5	1.6	35.7	1.6	2.0	27.4	1.7	2.4	21.0	1.8	2.9	16.6	2.0	3.3
80	100.3	1.3	0.9	69.5	1.4	1.3	50.6	1.5	1.6	38.1	1.6	2.0	29.1	1.7	2.4	22.5	1.8	2.9	17.8	2.0	3.3
85	106.6	1.3	0.9	73.8	1.4	1.3	53.7	1.5	1.6	40.5	1.6	2.0	30.9	1.7	2.4	23.9	1.8	2.9	18.9	2.0	3.3
90	112.9	1.3	0.9	78.2	1.4	1.3	56.9	1.5	1.6	42.8	1.6	2.0	32.7	1.7	2.4	25.7	1.8	2.9	20.1	2.0	3.3
95	119.1	1.3	0.9	82.5	1.4	1.3	60.0	1.5	1.6	45.2	1.6	2.0	34.5	1.7	2.4	27.1	1.8	2.9	21.2	2.0	3.3
100	125.4	1.3	0.9	86.9	1.4	1.3	63.2	1.5	1.6	47.6	1.6	2.0	36.3	1.7	2.4	28.5	1.8	2.9	22.4	2.0	3.3
105	131.7	1.3	0.9	91.2	1.4	1.3	66.4	1.5	1.6	50.0	1.6	2.0	38.1	1.7	2.4	29.9	1.8	2.9	23.5	2.0	3.3
110	138.0	1.3	0.9	95.5	1.4	1.3	69.5	1.5	1.6	52.3	1.6	2.0	40.0	1.7	2.4	31.3	1.8	2.9	24.7	2.0	3.3
115	144.2	1.3	0.9	99.9	1.4	1.3	72.7	1.5	1.6	54.7	1.6	2.0	41.8	1.7	2.4	32.8	1.8	2.9	25.8	2.0	3.3
120	150.5	1.3	0.9	104.2	1.4	1.3	75.8	1.5	1.6	57.1	1.6	2.0	43.6	1.7	2.4	34.2	1.8	2.9	27.0	2.0	3.3
125	156.8	1.3	0.9	108.6	1.4	1.3	79.0	1.5	1.6	59.5	1.6	2.0	45.4	1.7	2.4	35.6	1.8	2.9	28.5	2.0	3.3
130	163.0	1.3	0.9	112.9	1.4	1.3	82.2	1.5	1.6	61.8	1.6	2.0	47.2	1.7	2.4	37.0	1.8	2.9	29.6	2.0	3.3
135	169.3	1.3	0.9	117.2	1.4	1.3	85.3	1.5	1.6	64.2	1.6	2.0	49.0	1.7	2.4	38.4	1.8	2.9	30.8	1.9	3.3
140	175.6	1.3	0.9	121.6	1.4	1.3	88.5	1.5	1.6	66.6	1.6	2.0	50.8	1.7	2.4	39.8	1.8	2.9	31.9	1.9	3.3
145	181.8	1.3	0.9	125.9	1.4	1.3	91.6	1.5	1.6	69.0	1.6	2.0	52.6	1.7	2.4	41.3	1.8	2.9	33.0	1.9	3.3
150	188.1	1.3	0.9	130.3	1.4	1.3	94.8	1.5	1.6	71.3	1.6	2.0	54.4	1.7	2.4	42.7	1.8	2.9	34.2	1.9	3.3

RETARDANCE T2 AND D2

NOTE: Width and Depth dimensions are in feet. Velocity measurements are in feet per second.  
 Depth T2 does not include allowance for freeboard or settlement.

Table 6-39.1. Design Chart for Parabolic Vegetated Diversion, Waterway or Stormwater Conveyance (Continued)  
 V1 FOR RETARDANCE "D", TOP WIDTH (T), DEPTH (D), AND V2 FOR RETARDANCE "B"

Grade 1.75 Percent

Q CFS	V1-2.0		V1-2.5		V1-3.0		V1-3.5		V1-4.0		V1-4.5		V1-5.0		V1-5.5		V1-6.0	
	T	D	T	D	T	D	T	D	T	D	T	D	T	D	T	D	T	D
5	6.5	1.3	0.9															
10	13.5	1.2	0.9	9.1	1.4	1.2	6.4	1.6	1.5									
15	20.5	1.2	0.9	13.9	1.3	1.2	10.0	1.4	1.6	7.2	1.7	1.9						
20	27.3	1.2	0.9	18.8	1.3	1.2	13.6	1.4	1.6	10.0	1.6	1.9	7.3	1.8	2.3			
25	34.1	1.2	0.9	23.5	1.3	1.2	17.0	1.4	1.6	12.7	1.5	1.9	9.5	1.7	2.3	6.8	2.0	2.7
30	40.9	1.2	0.9	28.2	1.3	1.2	20.7	1.4	1.6	15.4	1.5	1.9	11.6	1.7	2.3	8.7	1.9	2.8
35	47.7	1.2	0.9	32.8	1.3	1.2	24.1	1.4	1.6	17.9	1.5	2.0	13.6	1.6	2.4	10.4	1.8	2.8
40	54.5	1.2	0.9	37.5	1.3	1.2	27.5	1.4	1.6	20.8	1.5	1.9	15.7	1.6	2.4	12.1	1.8	2.8
45	61.3	1.2	0.9	42.2	1.3	1.2	30.9	1.4	1.6	23.4	1.5	1.9	17.7	1.6	2.4	13.7	1.8	2.8
50	68.1	1.2	0.9	46.9	1.3	1.2	34.4	1.4	1.6	26.0	1.5	1.9	19.7	1.6	2.4	15.3	1.7	2.8
55	74.9	1.2	0.9	51.6	1.3	1.2	37.8	1.4	1.6	28.5	1.5	1.9	22.1	1.6	2.3	16.9	1.7	2.8
60	81.7	1.2	0.9	56.2	1.3	1.2	41.2	1.4	1.6	31.1	1.5	2.0	24.0	1.6	2.3	18.5	1.7	2.8
65	88.5	1.2	0.9	60.9	1.3	1.2	44.6	1.4	1.6	33.7	1.5	2.0	26.0	1.6	2.4	20.1	1.7	2.8
70	95.4	1.2	0.9	65.6	1.3	1.2	48.1	1.4	1.6	36.3	1.5	2.0	28.0	1.6	2.4	21.6	1.7	2.9
75	102.2	1.2	0.9	70.3	1.3	1.2	51.5	1.4	1.6	38.9	1.5	2.0	30.0	1.6	2.4	23.2	1.7	2.9
80	109.0	1.2	0.9	75.0	1.3	1.2	54.9	1.4	1.6	41.5	1.5	2.0	32.0	1.6	2.4	25.1	1.7	2.8
85	115.8	1.2	0.9	79.6	1.3	1.2	58.3	1.4	1.6	44.1	1.5	2.0	34.0	1.6	2.4	26.6	1.7	2.8
90	122.6	1.2	0.9	84.3	1.3	1.2	61.8	1.4	1.6	46.6	1.5	2.0	36.0	1.6	2.4	28.2	1.7	2.8
95	129.4	1.2	0.9	89.0	1.3	1.2	65.2	1.4	1.6	49.2	1.5	2.0	37.9	1.6	2.4	29.8	1.7	2.8
100	136.2	1.2	0.9	93.7	1.3	1.2	68.6	1.4	1.6	51.8	1.5	2.0	39.8	1.6	2.4	31.3	1.7	2.8
105	143.0	1.2	0.9	98.4	1.3	1.2	72.1	1.4	1.6	54.4	1.5	2.0	41.8	1.6	2.4	32.9	1.7	2.8
110	149.8	1.2	0.9	103.1	1.3	1.2	75.5	1.4	1.6	57.0	1.5	2.0	43.8	1.6	2.4	34.4	1.7	2.8
115	156.6	1.2	0.9	107.7	1.3	1.2	78.9	1.4	1.6	59.6	1.5	2.0	45.8	1.6	2.4	36.0	1.7	2.8
120	163.4	1.2	0.9	112.4	1.3	1.2	82.3	1.4	1.6	62.2	1.5	2.0	47.8	1.6	2.4	37.6	1.7	2.8
125	170.3	1.2	0.9	117.1	1.3	1.2	85.8	1.4	1.6	64.8	1.5	2.0	49.8	1.6	2.4	39.1	1.7	2.9
130	177.1	1.2	0.9	121.8	1.3	1.2	89.2	1.4	1.6	67.3	1.5	2.0	51.8	1.6	2.4	40.7	1.7	2.9
135	183.9	1.2	0.9	126.5	1.3	1.2	92.6	1.4	1.6	69.9	1.5	2.0	53.8	1.6	2.4	42.2	1.7	2.9
140	190.7	1.2	0.9	131.2	1.3	1.2	96.1	1.4	1.6	72.5	1.5	2.0	55.7	1.6	2.4	43.8	1.7	2.9
145	197.5	1.2	0.9	135.8	1.3	1.2	99.5	1.4	1.6	75.1	1.5	2.0	57.7	1.6	2.4	45.3	1.7	2.9
150	204.3	1.2	0.9	140.5	1.3	1.2	102.9	1.4	1.6	77.7	1.5	2.0	59.7	1.6	2.4	46.9	1.7	2.9

RETARDANCE "B" AND "D"

NOTE: Width and Depth dimensions are in feet. Velocity measurements are in feet per second.  
 Depth "D" does not include allowance for freeboard or settlement.



Table 6-39.1. Design Chart for Parabolic Vegetated Diversion, Waterway or Stormwater Conveyance (Continued)  
 V1 FOR RETARDANCE "D", TOP WIDTH (T), DEPTH (D), AND V2 FOR RETARDANCE "B"

Grade 3.00 Percent

Q CFS	V1-2.0		V1-2.5		V1-3.0		V1-3.5		V1-4.0		V1-4.5		V1-5.0		V1-5.5		V1-6.0	
	T	D	T	D	T	D	T	D	T	D	T	D	T	D	T	D	T	D
5	8.8	1.0	0.8	5.8	1.1	1.1	3.9	1.5	1.3									
10	18.0	1.0	0.8	12.1	1.1	1.2	8.9	1.1	1.5	6.6	1.3	1.8	4.7	1.5	2.1			
15	27.0	1.0	0.8	18.3	1.1	1.2	13.5	1.1	1.5	10.3	1.2	1.8	7.9	1.3	2.2	6.0	1.5	2.5
20	35.9	1.0	0.8	24.4	1.1	1.2	18.2	1.1	1.5	13.8	1.2	1.8	10.7	1.3	2.2	8.3	1.4	2.6
25	44.9	1.0	0.8	30.5	1.1	1.2	22.8	1.1	1.5	17.5	1.2	1.8	13.4	1.3	2.2	10.6	1.4	2.6
30	53.9	1.0	0.8	36.6	1.1	1.2	27.3	1.1	1.5	20.9	1.2	1.8	16.2	1.3	2.2	12.8	1.4	2.6
35	62.8	1.0	0.8	42.7	1.1	1.2	31.8	1.1	1.5	24.4	1.2	1.8	19.1	1.2	2.2	15.0	1.3	2.6
40	71.8	1.0	0.8	48.8	1.1	1.2	36.4	1.1	1.5	27.9	1.2	1.8	21.9	1.2	2.2	17.2	1.3	2.6
45	80.8	1.0	0.8	54.9	1.0	1.2	40.9	1.1	1.5	31.3	1.2	1.8	24.6	1.2	2.2	19.6	1.3	2.6
50	89.7	1.0	0.8	60.9	1.0	1.2	45.4	1.1	1.5	34.8	1.2	1.8	27.3	1.2	2.2	21.8	1.3	2.6
55	98.7	1.0	0.8	67.0	1.0	1.2	50.0	1.1	1.5	38.3	1.2	1.8	30.0	1.2	2.2	24.0	1.3	2.6
60	107.7	1.0	0.8	73.1	1.0	1.2	54.5	1.1	1.5	41.8	1.2	1.8	32.7	1.2	2.2	26.1	1.3	2.6
65	116.6	1.0	0.8	79.2	1.0	1.2	59.0	1.1	1.5	45.2	1.2	1.8	35.5	1.2	2.2	28.3	1.3	2.6
70	125.6	1.0	0.8	85.3	1.0	1.2	63.6	1.1	1.5	48.7	1.2	1.8	38.2	1.2	2.2	30.5	1.3	2.6
75	134.6	1.0	0.8	91.4	1.0	1.2	68.1	1.1	1.5	52.2	1.2	1.9	40.9	1.2	2.2	32.6	1.3	2.6
80	143.6	1.0	0.8	97.5	1.0	1.2	72.7	1.1	1.5	55.7	1.2	1.9	43.6	1.2	2.2	34.8	1.3	2.6
85	152.5	1.0	0.8	103.6	1.0	1.2	77.2	1.1	1.5	59.1	1.2	1.9	46.3	1.2	2.2	37.0	1.3	2.6
90	161.5	1.0	0.8	109.7	1.0	1.2	81.7	1.1	1.5	62.6	1.2	1.9	49.1	1.2	2.2	39.1	1.3	2.6
95	170.5	1.0	0.8	115.8	1.0	1.2	86.3	1.1	1.5	66.1	1.2	1.9	51.8	1.2	2.2	41.3	1.3	2.6
100	179.5	1.0	0.8	121.9	1.0	1.2	90.8	1.1	1.5	69.6	1.2	1.9	54.5	1.2	2.2	43.5	1.3	2.6
105	188.4	1.0	0.8	128.0	1.0	1.2	95.4	1.1	1.5	73.0	1.2	1.9	57.2	1.2	2.2	45.6	1.3	2.6
110	197.4	1.0	0.8	134.1	1.0	1.2	99.9	1.1	1.5	76.5	1.2	1.9	60.0	1.2	2.2	47.8	1.3	2.6
115	206.4	1.0	0.8	140.1	1.0	1.2	104.4	1.1	1.5	80.0	1.2	1.9	62.7	1.2	2.2	50.0	1.3	2.6
120	215.3	1.0	0.8	146.2	1.0	1.2	109.0	1.1	1.5	83.5	1.2	1.9	65.4	1.2	2.2	52.2	1.3	2.6
125	224.3	1.0	0.8	152.3	1.0	1.2	113.5	1.1	1.5	86.9	1.2	1.9	68.1	1.2	2.2	54.3	1.3	2.6
130	233.3	1.0	0.8	158.4	1.0	1.2	118.1	1.1	1.5	90.4	1.2	1.9	70.9	1.2	2.2	56.5	1.3	2.6
135	242.3	1.0	0.8	164.5	1.0	1.2	122.6	1.1	1.5	93.9	1.2	1.9	73.6	1.2	2.2	58.7	1.3	2.6
140	251.2	1.0	0.8	170.6	1.0	1.2	127.1	1.1	1.5	97.4	1.2	1.9	76.3	1.2	2.2	60.8	1.3	2.6
145	260.2	1.0	0.8	176.7	1.0	1.2	131.7	1.1	1.5	100.9	1.2	1.9	79.0	1.2	2.2	63.0	1.3	2.6
150	269.2	1.0	0.8	182.8	1.0	1.2	136.2	1.1	1.5	104.3	1.2	1.9	81.7	1.2	2.2	65.2	1.3	2.6

RETARDANCE "B" AND "D"

NOTE: Width and Depth dimensions are in feet; Velocity measurements are in feet per second; Depth "D" does not include allowance for freeboard or settlement.

Table 6-39.1. Design Chart for Parabolic Vegetated Diversion, Waterway or Stormwater Conveyance (Continued)  
 V1 FOR RETARDANCE T, TOP WIDTH (T), DEPTH (D), AND V2 FOR RETARDANCE T\*

Scale 4.00 Percent

D CFS	V1-2.0		V1-2.5		V1-3.0		V1-3.5		V1-4.0		V1-4.5		V1-5.0		V1-5.5		V1-6.0	
	T	D	T	D	T	D	T	D	T	D	T	D	T	D	T	D	T	D
5	70.1	0.9	0.8	7.0	1.0	1.1	1.4											
10	20.5	0.9	0.8	14.4	0.9	1.1	10.3	1.0	1.4	7.9	1.1	1.8	6.1	1.2	2.1	4.5	1.4	2.4
15	30.7	0.9	0.8	21.5	0.9	1.1	15.7	1.0	1.4	12.0	1.1	1.8	9.4	1.1	2.1	7.4	1.2	2.5
20	40.9	0.9	0.8	28.6	0.9	1.1	20.9	1.0	1.4	16.3	1.0	1.8	12.6	1.1	2.1	10.1	1.2	2.5
25	51.1	0.9	0.8	35.8	0.9	1.1	26.1	1.0	1.4	20.3	1.0	1.8	16.0	1.1	2.1	12.7	1.2	2.5
30	61.3	0.9	0.8	42.9	0.9	1.1	31.4	1.0	1.4	24.4	1.0	1.8	19.2	1.1	2.1	15.2	1.2	2.5
35	71.5	0.9	0.8	50.1	0.9	1.1	36.6	1.0	1.4	28.3	1.0	1.8	22.4	1.1	2.1	18.0	1.2	2.5
40	81.8	0.9	0.8	57.2	0.9	1.1	41.8	1.0	1.5	32.4	1.0	1.8	25.6	1.1	2.1	20.6	1.2	2.5
45	92.0	0.9	0.8	64.4	0.9	1.1	47.0	1.0	1.5	36.4	1.0	1.8	28.8	1.1	2.1	23.1	1.2	2.5
50	102.2	0.9	0.8	71.5	0.9	1.1	52.2	1.0	1.5	40.5	1.0	1.8	32.0	1.1	2.1	25.7	1.2	2.5
55	112.4	0.9	0.8	78.7	0.9	1.1	57.5	1.0	1.5	44.5	1.0	1.8	35.2	1.1	2.1	28.2	1.2	2.5
60	122.6	0.9	0.8	85.8	0.9	1.1	62.7	1.0	1.5	48.5	1.0	1.8	38.4	1.1	2.2	30.8	1.2	2.5
65	132.8	0.9	0.8	93.0	0.9	1.1	67.9	1.0	1.5	52.6	1.0	1.8	41.5	1.1	2.2	33.4	1.2	2.5
70	143.1	0.9	0.8	100.1	0.9	1.1	73.1	1.0	1.5	56.6	1.0	1.8	44.7	1.1	2.2	35.9	1.2	2.5
75	153.5	0.9	0.8	107.3	0.9	1.1	78.3	1.0	1.5	60.7	1.0	1.8	47.9	1.1	2.2	38.5	1.2	2.5
80	163.5	0.9	0.8	114.4	0.9	1.1	83.6	1.0	1.5	64.7	1.0	1.8	51.1	1.1	2.2	41.0	1.2	2.5
85	173.7	0.9	0.8	121.6	0.9	1.1	88.8	1.0	1.5	68.8	1.0	1.8	54.3	1.1	2.2	43.6	1.2	2.5
90	183.9	0.9	0.8	128.7	0.9	1.1	94.0	1.0	1.5	72.8	1.0	1.8	57.5	1.1	2.2	46.2	1.2	2.5
95	194.1	0.9	0.8	135.9	0.9	1.1	99.2	1.0	1.5	76.8	1.0	1.8	60.7	1.1	2.2	48.7	1.2	2.5
100	204.4	0.9	0.8	143.0	0.9	1.1	104.4	1.0	1.5	80.9	1.0	1.8	63.9	1.1	2.2	51.3	1.2	2.5
105	214.6	0.9	0.8	150.2	0.9	1.1	109.7	1.0	1.5	84.9	1.0	1.8	67.1	1.1	2.2	53.9	1.2	2.5
110	224.8	0.9	0.8	157.4	0.9	1.1	114.9	1.0	1.5	89.0	1.0	1.8	70.3	1.1	2.2	56.4	1.2	2.5
115	235.0	0.9	0.8	164.5	0.9	1.1	120.1	1.0	1.5	93.0	1.0	1.8	73.5	1.1	2.2	59.0	1.2	2.5
120	245.2	0.9	0.8	171.7	0.9	1.1	125.3	1.0	1.5	97.1	1.0	1.8	76.7	1.1	2.2	61.5	1.2	2.5
125	255.5	0.9	0.8	178.8	0.9	1.1	130.5	1.0	1.5	101.1	1.0	1.8	79.9	1.1	2.2	64.1	1.2	2.5
130	265.7	0.9	0.8	186.0	0.9	1.1	135.8	1.0	1.5	105.1	1.0	1.8	83.0	1.1	2.2	66.7	1.2	2.5
135	275.9	0.9	0.8	193.1	0.9	1.1	141.0	1.0	1.5	109.2	1.0	1.8	86.2	1.1	2.2	69.2	1.2	2.5
140	286.1	0.9	0.8	200.3	0.9	1.1	146.2	1.0	1.5	113.2	1.0	1.8	89.4	1.1	2.2	71.8	1.2	2.5
145	296.3	0.9	0.8	207.4	0.9	1.1	151.4	1.0	1.5	117.3	1.0	1.8	92.6	1.1	2.2	74.4	1.2	2.5
150	306.5	0.9	0.8	214.6	0.9	1.1	156.7	1.0	1.5	121.3	1.0	1.8	95.8	1.1	2.2	76.9	1.2	2.5

RETARDANCE T\* AND D\*

NOTE: Width and Depth dimensions are in feet. Velocity measurements are in feet per second.  
 Depth T\* does not include allowance for freeboard or settlement.

Table 6-39.1. Design Chart for Parabolic Vegetated Diversion, Waterway or Stormwater Conveyance (Continued)  
 V1 FOR RETARDANCE 'D', TOP WIDTH (T), DEPTH (D), AND V2 FOR RETARDANCE 'B'

Grade 5.00 Percent

Q CFR	V1-2.0		V1-2.5		V1-3.0		V1-3.5		V1-4.0		V1-4.5		V1-5.0		V1-5.5		V1-6.0	
	T	D	T	D	T	D	T	D	T	D	T	D	T	D	T	D	T	D
5	11.3	0.8	8.0	0.9	5.6	1.0	4.2	1.1	1.6									
10	22.5	0.8	16.3	0.9	11.5	0.9	8.9	1.0	1.7	7.0	1.0	2.0	5.5	1.2	2.4	4.0	1.4	2.6
15	33.7	0.8	24.3	0.9	17.4	0.9	13.7	1.0	1.7	10.7	1.0	2.1	8.5	1.1	2.4	6.8	1.2	2.8
20	45.0	0.8	32.4	0.9	23.2	0.9	18.2	1.0	1.7	14.5	1.0	2.1	11.5	1.1	2.5	9.3	1.1	2.8
25	56.2	0.8	40.5	0.9	28.9	0.9	22.8	1.0	1.7	18.1	1.0	2.1	14.6	1.1	2.4	11.7	1.1	2.8
30	67.4	0.8	48.7	0.9	34.7	0.9	27.3	1.0	1.7	21.7	1.0	2.1	17.5	1.1	2.4	14.1	1.1	2.8
35	78.7	0.8	56.8	0.9	40.5	0.9	31.8	1.0	1.7	25.3	1.0	2.1	20.4	1.0	2.5	16.7	1.1	2.8
40	89.9	0.8	64.9	0.9	46.3	0.9	36.4	1.0	1.7	28.8	1.0	2.1	23.3	1.0	2.5	19.1	1.1	2.8
45	101.1	0.8	73.0	0.9	52.1	0.9	40.9	1.0	1.7	32.4	1.0	2.1	26.2	1.0	2.5	21.5	1.1	2.8
50	112.4	0.8	81.1	0.9	57.9	0.9	45.5	1.0	1.7	36.0	1.0	2.1	29.1	1.0	2.5	23.9	1.1	2.8
55	123.6	0.8	89.2	0.9	63.6	0.9	50.0	1.0	1.7	39.6	1.0	2.1	32.0	1.0	2.5	26.2	1.1	2.8
60	134.8	0.8	97.3	0.9	69.4	0.9	54.5	1.0	1.7	43.2	1.0	2.1	34.9	1.0	2.5	28.6	1.1	2.8
65	146.1	0.8	105.4	0.9	75.2	0.9	59.1	1.0	1.7	46.8	1.0	2.1	37.8	1.0	2.5	31.0	1.1	2.8
70	157.3	0.8	113.5	0.9	81.0	0.9	63.6	1.0	1.7	50.4	1.0	2.1	40.7	1.0	2.5	33.4	1.1	2.8
75	168.6	0.8	121.6	0.9	86.8	0.9	68.2	1.0	1.7	54.0	1.0	2.1	43.6	1.0	2.5	35.8	1.1	2.8
80	179.8	0.8	129.7	0.9	92.6	0.9	72.7	0.9	1.7	57.6	1.0	2.1	46.5	1.0	2.5	38.1	1.1	2.8
85	191.0	0.8	137.8	0.9	98.3	0.9	77.3	0.9	1.7	61.2	1.0	2.1	49.4	1.0	2.5	40.5	1.1	2.8
90	202.3	0.8	145.9	0.9	104.1	0.9	81.8	0.9	1.7	64.9	1.0	2.1	52.3	1.0	2.5	42.9	1.1	2.8
95	213.5	0.8	154.0	0.9	109.9	0.9	86.3	0.9	1.7	68.5	1.0	2.1	55.2	1.0	2.5	45.3	1.1	2.8
100	224.7	0.8	162.1	0.9	115.7	0.9	90.9	0.9	1.7	72.1	1.0	2.1	58.1	1.0	2.5	47.7	1.1	2.8
105	236.0	0.8	170.2	0.9	121.5	0.9	95.4	0.9	1.7	75.7	1.0	2.1	61.0	1.0	2.5	50.0	1.1	2.8
110	247.2	0.8	178.3	0.9	127.3	0.9	100.0	0.9	1.7	79.3	1.0	2.1	64.0	1.0	2.5	52.4	1.1	2.8
115	258.5	0.8	186.4	0.9	133.0	0.9	104.5	0.9	1.7	82.9	1.0	2.1	66.9	1.0	2.5	54.8	1.1	2.8
120	269.7	0.8	194.6	0.9	138.8	0.9	109.1	0.9	1.7	86.5	1.0	2.1	69.8	1.0	2.5	57.2	1.1	2.8
125	280.9	0.8	202.7	0.9	144.6	0.9	113.6	0.9	1.7	90.1	1.0	2.1	72.7	1.0	2.5	59.6	1.1	2.8
130	292.2	0.8	210.8	0.9	150.4	0.9	118.2	0.9	1.7	93.7	1.0	2.1	75.6	1.0	2.5	61.9	1.1	2.8
135	303.4	0.8	218.9	0.9	156.2	0.9	122.7	0.9	1.7	97.3	1.0	2.1	78.5	1.0	2.5	64.3	1.1	2.8
140	314.6	0.8	227.0	0.9	162.0	0.9	127.2	0.9	1.7	100.9	1.0	2.1	81.4	1.0	2.5	66.7	1.1	2.8
145	325.9	0.8	235.1	0.9	167.8	0.9	131.8	0.9	1.7	104.5	1.0	2.1	84.3	1.0	2.5	69.1	1.1	2.8
150	337.1	0.8	243.2	0.9	173.5	0.9	136.3	0.9	1.7	108.1	1.0	2.1	87.2	1.0	2.5	71.5	1.1	2.8

RETARDANCE "D" AND "B"

NOTE: Width and Depth dimensions are in feet; Velocity measurements are in feet per second; Depth "D" does not include allowance for freeboard or settlement.

Table 6-39.1. Design Chart for Parabolic Vegetated Diversion, Waterway or Stormwater Conveyance (Continued)  
 V1 FOR RETARDANCE T<sub>1</sub>, TOP WIDTH (T<sub>1</sub>), DEPTH (D<sub>1</sub>), AND V2 FOR RETARDANCE T<sub>2</sub>

Grade 6.00 Percent

Q CFS	V1-2.0		V1-2.5		V1-3.0		V1-3.5		V1-4.0		V1-4.5		V1-5.0		V1-5.5		V1-6.0	
	T	D	T	D	T	D	T	D	T	D	T	D	T	D	T	D	T	D
5	12.4	0.7	0.8	8.7	1.0	1.6	4.7	1.0	1.6	3.5	1.2	1.9						
10	24.7	0.7	0.8	17.6	1.0	1.7	9.8	0.9	1.7	7.8	1.0	2.0	6.2	1.0	2.3	4.9	1.1	2.7
15	37.1	0.7	0.8	26.4	0.8	1.1	19.2	0.8	1.4	15.0	0.9	2.0	9.5	1.0	2.4	7.7	1.1	2.7
20	49.4	0.7	0.8	35.1	0.8	1.1	25.6	0.8	1.4	19.9	0.9	2.0	12.9	1.0	2.4	10.4	1.0	2.8
25	61.8	0.7	0.8	43.9	0.8	1.1	32.0	0.8	1.4	24.9	0.9	2.0	16.1	1.0	2.4	13.1	1.0	2.8
30	74.1	0.7	0.8	52.7	0.8	1.1	38.4	0.8	1.4	29.9	0.9	2.1	19.3	1.0	2.4	15.9	1.0	2.8
35	86.5	0.7	0.8	61.5	0.8	1.1	44.8	0.8	1.4	34.8	0.9	2.1	22.5	1.0	2.4	18.5	1.0	2.8
40	98.9	0.7	0.8	70.2	0.8	1.1	51.2	0.8	1.4	39.8	0.9	2.1	25.7	1.0	2.4	21.2	1.0	2.8
45	111.2	0.7	0.8	79.0	0.8	1.1	57.6	0.8	1.4	44.8	0.9	2.1	29.0	1.0	2.4	23.8	1.0	2.8
50	123.6	0.7	0.8	87.8	0.8	1.1	64.0	0.8	1.4	49.7	0.9	2.1	32.2	1.0	2.4	26.4	1.0	2.8
55	135.9	0.7	0.8	96.6	0.8	1.1	70.4	0.8	1.4	54.7	0.9	2.1	35.4	1.0	2.4	29.1	1.0	2.8
60	148.3	0.7	0.8	105.3	0.8	1.1	76.8	0.8	1.4	59.7	0.9	2.1	38.6	1.0	2.4	31.7	1.0	2.8
65	160.6	0.7	0.8	114.1	0.8	1.1	83.2	0.8	1.4	64.7	0.9	2.1	41.8	1.0	2.4	34.3	1.0	2.8
70	173.0	0.7	0.8	122.9	0.8	1.1	89.6	0.8	1.4	69.6	0.9	2.1	45.0	1.0	2.4	37.0	1.0	2.8
75	185.4	0.7	0.8	131.7	0.8	1.1	96.0	0.8	1.4	74.6	0.9	2.1	48.2	1.0	2.4	39.6	1.0	2.8
80	197.7	0.7	0.8	140.4	0.8	1.1	102.3	0.8	1.4	79.6	0.9	2.1	51.4	1.0	2.4	42.2	1.0	2.8
85	210.1	0.7	0.8	149.2	0.8	1.1	108.7	0.8	1.4	84.5	0.9	2.1	54.7	1.0	2.4	44.9	1.0	2.8
90	222.4	0.7	0.8	158.0	0.8	1.1	115.1	0.8	1.4	89.5	0.9	2.1	57.9	1.0	2.4	47.5	1.0	2.8
95	234.8	0.7	0.8	166.8	0.8	1.1	121.5	0.8	1.4	94.5	0.9	2.1	61.1	1.0	2.4	50.2	1.0	2.8
100	247.1	0.7	0.8	175.5	0.8	1.1	127.9	0.8	1.4	99.5	0.9	2.1	64.3	1.0	2.4	52.8	1.0	2.8
105	259.5	0.7	0.8	184.3	0.8	1.1	134.3	0.8	1.4	104.4	0.9	2.1	67.5	1.0	2.4	55.4	1.0	2.8
110	271.8	0.7	0.8	193.1	0.8	1.1	140.7	0.8	1.4	109.4	0.9	2.1	70.7	1.0	2.4	58.1	1.0	2.8
115	284.2	0.7	0.8	201.9	0.8	1.1	147.1	0.8	1.4	114.4	0.9	2.1	73.9	1.0	2.4	60.7	1.0	2.8
120	296.6	0.7	0.8	210.7	0.8	1.1	153.5	0.8	1.4	119.3	0.9	2.1	77.2	1.0	2.4	63.3	1.0	2.8
125	308.9	0.7	0.8	219.4	0.8	1.1	159.9	0.8	1.4	124.3	0.9	2.1	80.4	1.0	2.4	66.0	1.0	2.8
130	321.3	0.7	0.8	228.2	0.8	1.1	166.3	0.8	1.4	129.3	0.9	2.1	83.6	1.0	2.4	68.6	1.0	2.8
135	333.6	0.7	0.8	237.0	0.8	1.1	172.7	0.8	1.4	134.3	0.9	2.1	86.8	1.0	2.4	71.3	1.0	2.8
140	346.0	0.7	0.8	245.8	0.8	1.1	179.1	0.8	1.4	139.2	0.9	2.1	90.0	1.0	2.4	73.9	1.0	2.8
145	358.3	0.7	0.8	254.5	0.8	1.1	185.5	0.8	1.4	144.2	0.9	2.1	93.2	1.0	2.4	76.5	1.0	2.8
150	370.7	0.7	0.8	263.3	0.8	1.1	191.9	0.8	1.4	149.2	0.9	2.1	96.4	1.0	2.4	79.2	1.0	2.8

RETARDANCE T<sub>1</sub> AND D<sub>1</sub>

NOTE: Width and Depth dimensions are in feet; Velocity measurements are in feet per second; Depth T<sub>1</sub> does not include allowance for freeboard or settlement.

Table 6-39.1. Design Chart for Parabolic Vegetated Diversion, Waterway or Stormwater Conveyance (Continued)  
 V1 FOR RETARDANCE "D", TOP WIDTH (T), DEPTH (D), AND V2 FOR RETARDANCE "B"

Grade 8.00 Percent

Q CFS	V1-2.0			V1-2.5			V1-3.0			V1-3.5			V1-4.0			V1-4.5			V1-5.0			V1-5.5			V1-6.0		
	T	D	V2	T	D	V2	T	D	V2	T	D	V2	T	D	V2	T	D	V2	T	D	V2	T	D	V2	T	D	V2
5	14.0	0.7	0.8	10.1	0.7	1.0	7.4	0.8	1.3	5.5	0.8	1.6	4.4	0.9	1.9	3.4	1.0	2.1									
10	28.0	0.7	0.8	20.1	0.7	1.0	15.0	0.8	1.3	11.3	0.8	1.7	9.1	0.8	2.0	7.4	0.9	2.3	6.0	0.9	2.6	4.9	1.0	3.0	3.8	1.2	3.3
15	41.9	0.7	0.8	30.1	0.7	1.0	22.4	0.8	1.3	17.0	0.8	1.7	13.9	0.8	2.0	11.4	0.9	2.3	9.2	0.9	2.7	7.6	1.0	3.0	6.3	1.0	3.4
20	55.9	0.7	0.8	40.1	0.7	1.0	29.9	0.8	1.3	22.6	0.8	1.7	18.5	0.8	2.0	15.1	0.9	2.3	12.5	0.9	2.7	10.2	1.0	3.1	8.5	1.0	3.5
25	69.9	0.7	0.8	50.1	0.7	1.0	37.3	0.8	1.3	28.2	0.8	1.7	23.1	0.8	2.0	18.8	0.9	2.3	15.6	0.9	2.7	13.0	0.9	3.1	10.8	1.0	3.5
30	83.9	0.7	0.8	60.1	0.7	1.0	44.8	0.8	1.3	33.9	0.8	1.7	27.7	0.8	2.0	22.6	0.9	2.3	18.6	0.9	2.7	15.6	0.9	3.1	13.0	1.0	3.5
35	97.9	0.7	0.8	70.1	0.7	1.0	52.3	0.8	1.3	39.5	0.8	1.7	32.3	0.8	2.0	26.3	0.9	2.3	21.7	0.9	2.7	18.2	0.9	3.1	15.3	1.0	3.5
40	111.8	0.7	0.8	80.2	0.7	1.0	59.7	0.8	1.3	46.1	0.8	1.7	36.9	0.8	2.0	30.1	0.9	2.3	24.8	0.9	2.7	20.8	0.9	3.1	17.5	1.0	3.5
45	125.8	0.7	0.8	90.2	0.7	1.0	67.2	0.8	1.3	50.8	0.8	1.7	41.5	0.8	2.0	33.8	0.9	2.3	27.9	0.9	2.7	23.3	0.9	3.1	19.7	1.0	3.5
50	139.8	0.7	0.8	100.2	0.7	1.0	74.7	0.8	1.3	56.4	0.8	1.7	46.1	0.8	2.0	37.6	0.9	2.3	31.0	0.9	2.7	25.9	0.9	3.1	21.9	1.0	3.5
55	153.8	0.7	0.8	110.2	0.7	1.0	82.1	0.8	1.3	62.1	0.8	1.7	50.7	0.8	2.0	41.3	0.9	2.3	34.1	0.9	2.7	28.5	0.9	3.1	24.0	1.0	3.5
60	167.8	0.7	0.8	120.2	0.7	1.0	89.6	0.8	1.3	67.7	0.8	1.7	55.3	0.8	2.0	45.1	0.9	2.3	37.2	0.9	2.7	31.1	0.9	3.1	26.2	1.0	3.5
65	181.7	0.7	0.8	130.3	0.7	1.0	97.0	0.8	1.3	73.3	0.8	1.7	60.0	0.8	2.0	48.8	0.9	2.3	40.3	0.9	2.7	33.7	0.9	3.1	28.4	1.0	3.5
70	195.7	0.7	0.8	140.3	0.7	1.0	104.5	0.8	1.3	79.0	0.8	1.7	64.6	0.8	2.0	52.6	0.9	2.3	43.4	0.9	2.7	36.3	0.9	3.1	30.6	1.0	3.5
75	209.7	0.7	0.8	150.3	0.7	1.0	112.0	0.8	1.3	84.6	0.8	1.7	69.2	0.8	2.0	56.3	0.9	2.3	46.5	0.9	2.7	38.9	0.9	3.1	32.8	1.0	3.5
80	223.7	0.7	0.8	160.3	0.7	1.0	119.4	0.8	1.3	90.3	0.8	1.7	73.8	0.8	2.0	60.1	0.9	2.3	49.6	0.9	2.7	41.4	0.9	3.1	35.0	1.0	3.5
85	237.7	0.7	0.8	170.3	0.7	1.0	126.9	0.8	1.3	95.9	0.8	1.7	78.4	0.8	2.0	63.8	0.9	2.3	52.7	0.9	2.7	44.0	0.9	3.1	37.1	1.0	3.5
90	251.6	0.7	0.8	180.3	0.7	1.0	134.4	0.8	1.3	101.6	0.8	1.7	83.0	0.8	2.0	67.6	0.9	2.3	55.8	0.9	2.7	46.6	0.9	3.1	39.3	1.0	3.5
95	265.6	0.7	0.8	190.4	0.7	1.0	141.8	0.8	1.3	107.2	0.8	1.7	87.6	0.8	2.0	71.3	0.9	2.3	58.9	0.9	2.7	49.2	0.9	3.1	41.5	1.0	3.5
100	279.6	0.7	0.8	200.4	0.7	1.0	149.3	0.8	1.3	112.8	0.8	1.7	92.2	0.8	2.0	75.1	0.9	2.3	62.0	0.9	2.7	51.8	0.9	3.1	43.7	1.0	3.5
105	293.6	0.7	0.8	210.4	0.7	1.0	156.8	0.8	1.3	118.5	0.8	1.7	96.8	0.8	2.0	78.9	0.9	2.3	65.1	0.9	2.7	54.4	0.9	3.1	45.9	1.0	3.5
110	307.6	0.7	0.8	220.4	0.7	1.0	164.2	0.8	1.3	124.1	0.8	1.7	101.4	0.8	2.0	82.6	0.9	2.3	68.2	0.9	2.7	57.0	0.9	3.1	48.0	1.0	3.5
115	321.5	0.7	0.8	230.4	0.7	1.0	171.7	0.8	1.3	129.8	0.8	1.7	106.1	0.8	2.0	86.4	0.9	2.3	71.3	0.9	2.7	59.6	0.9	3.1	50.2	1.0	3.5
120	335.5	0.7	0.8	240.5	0.7	1.0	179.1	0.8	1.3	135.4	0.8	1.7	110.7	0.8	2.0	90.1	0.9	2.3	74.4	0.9	2.7	62.2	0.9	3.1	52.4	1.0	3.5
125	349.5	0.7	0.8	250.5	0.7	1.0	186.6	0.8	1.3	141.0	0.8	1.7	115.3	0.8	2.0	93.9	0.9	2.3	77.5	0.9	2.7	64.7	0.9	3.1	54.6	1.0	3.5
130	363.5	0.7	0.8	260.5	0.7	1.0	194.1	0.8	1.3	146.7	0.8	1.7	119.9	0.8	2.0	97.6	0.9	2.3	80.6	0.9	2.7	67.3	0.9	3.1	56.8	1.0	3.5
135	377.5	0.7	0.8	270.5	0.7	1.0	201.5	0.8	1.3	152.3	0.8	1.7	124.5	0.8	2.0	101.4	0.9	2.3	83.7	0.9	2.7	69.9	0.9	3.1	59.0	1.0	3.5
140	391.5	0.7	0.8	280.5	0.7	1.0	209.0	0.8	1.3	158.0	0.8	1.7	129.1	0.8	2.0	105.1	0.9	2.3	86.8	0.9	2.7	72.5	0.9	3.1	61.1	1.0	3.5
145	405.4	0.7	0.8	290.6	0.7	1.0	216.5	0.8	1.3	163.6	0.8	1.7	133.7	0.8	2.0	108.9	0.9	2.3	89.9	0.9	2.7	75.1	0.9	3.1	63.3	1.0	3.5
150	419.4	0.7	0.8	300.6	0.7	1.0	223.9	0.8	1.3	169.3	0.8	1.7	138.3	0.8	2.0	112.6	0.9	2.3	93.0	0.9	2.7	77.7	0.9	3.1	65.5	1.0	3.5

RETARDANCE "B" AND "D"

NOTE: Width and Depth dimensions are in feet. Velocity measurements are in feet per second.  
 Depth "D" does not include allowance for freeboard or settlement.



Table 6-39.1. Design Chart for Parabolic Vegetated Diversion, Waterway or Stormwater Conveyance (Continued)  
 V1 FOR RETARDANCE T<sub>r</sub>, TOP WIDTH (T), DEPTH (D), AND V2 FOR RETARDANCE T<sub>r</sub>

Grade: 10.00 Percent

Q CFs	V1-2.0		V1-2.5		V1-3.0		V1-3.5		V1-4.0		V1-4.5		V1-5.0		V1-5.5		V1-6.0			
	T	D	T	D	T	D	T	D	T	D	T	D	T	D	T	D	T	D		
5	15.3	0.6	11.1	0.7	8.1	0.7	6.3	0.7	4.8	0.8	4.0	0.9	3.1	1.0	2.4					
10	30.6	0.6	22.1	0.7	16.5	0.7	12.8	0.7	10.0	0.8	8.4	0.8	6.9	0.8	5.7	0.9	2.9	4.7	1.0	3.3
15	45.9	0.6	33.2	0.7	24.7	0.7	19.2	0.7	16.5	0.8	14.7	0.8	12.7	0.8	10.5	0.8	8.7	9.3	0.9	3.3
20	61.2	0.6	44.2	0.7	32.9	0.7	25.6	0.7	23.0	0.8	20.0	0.8	17.0	0.8	14.1	0.8	11.8	12.9	0.9	3.4
25	76.5	0.6	55.3	0.7	41.1	0.7	32.0	0.7	29.0	0.8	25.0	0.8	21.2	0.8	17.6	0.8	14.7	15.9	0.9	3.4
30	91.8	0.6	66.3	0.7	49.3	0.7	38.3	0.7	34.9	0.8	29.9	0.8	25.4	0.8	21.1	0.8	17.7	18.0	0.9	3.3
35	107.1	0.6	77.4	0.7	57.5	0.7	44.7	0.7	41.7	0.8	34.9	0.8	29.7	0.8	23.8	0.8	20.6	20.1	0.9	3.4
40	122.4	0.6	88.4	0.7	65.7	0.7	51.1	0.7	48.9	0.8	41.7	0.8	33.9	0.8	23.8	0.8	23.5	23.0	0.9	3.4
45	137.8	0.6	99.5	0.7	73.9	0.7	57.5	0.7	54.9	0.8	44.9	0.8	38.0	0.8	23.3	0.8	26.5	25.5	0.9	3.4
50	153.1	0.6	110.6	0.7	82.1	0.7	63.9	0.7	61.9	0.8	49.9	0.8	42.2	0.8	23.3	0.8	29.4	28.0	0.9	3.4
55	168.4	0.6	121.6	0.7	90.3	0.7	70.3	0.7	68.9	0.8	54.9	0.8	46.4	0.8	23.3	0.8	32.3	30.5	0.9	3.4
60	183.7	0.6	132.7	0.7	98.5	0.7	76.7	0.7	75.9	0.8	60.9	0.8	50.7	0.8	23.3	0.8	35.3	33.0	0.9	3.4
65	199.0	0.6	143.7	0.7	106.7	0.7	83.1	0.7	82.9	0.8	64.9	0.8	54.9	0.8	23.3	0.8	38.2	35.5	0.9	3.4
70	214.3	0.6	154.8	0.7	115.0	0.7	89.4	0.7	90.9	0.8	70.9	0.8	59.1	0.8	23.3	0.8	41.2	38.0	0.9	3.4
75	229.6	0.6	165.8	0.7	123.2	0.7	95.8	0.7	98.9	0.8	74.9	0.8	63.3	0.8	23.3	0.8	44.1	40.5	0.9	3.4
80	244.9	0.6	176.9	0.7	131.4	0.7	102.2	0.7	106.9	0.8	79.9	0.8	67.6	0.8	23.3	0.8	47.0	43.0	0.9	3.4
85	260.2	0.6	187.9	0.7	139.6	0.7	108.6	0.7	114.9	0.8	84.9	0.8	71.8	0.8	23.3	0.8	50.0	45.5	0.9	3.4
90	275.5	0.6	199.0	0.7	147.8	0.7	115.0	0.7	122.9	0.8	89.9	0.8	76.0	0.8	23.3	0.8	52.9	48.0	0.9	3.4
95	290.8	0.6	210.0	0.7	156.0	0.7	121.4	0.7	130.9	0.8	94.9	0.8	80.2	0.8	23.3	0.8	55.8	50.5	0.9	3.4
100	306.1	0.6	221.1	0.7	164.2	0.7	127.8	0.7	138.9	0.8	99.9	0.8	84.4	0.8	23.3	0.8	58.8	53.0	0.9	3.4
105	321.4	0.6	232.2	0.7	172.4	0.7	134.2	0.7	146.9	0.8	104.7	0.8	88.7	0.8	23.3	0.8	61.7	55.5	0.9	3.4
110	336.7	0.6	243.2	0.7	180.6	0.7	140.5	0.7	154.9	0.8	109.7	0.8	92.9	0.8	23.3	0.8	64.7	58.0	0.9	3.4
115	352.0	0.6	254.3	0.7	188.8	0.7	146.9	0.7	162.9	0.8	114.7	0.8	97.1	0.8	23.3	0.8	67.6	60.5	0.9	3.4
120	367.3	0.6	265.3	0.7	197.1	0.7	153.3	0.7	170.9	0.8	119.7	0.8	101.3	0.8	23.3	0.8	70.5	63.0	0.9	3.4
125	382.6	0.6	276.4	0.7	205.3	0.7	159.7	0.7	178.9	0.8	124.7	0.8	105.5	0.8	23.3	0.8	73.5	65.5	0.9	3.4
130	397.9	0.6	287.4	0.7	213.5	0.7	166.1	0.7	186.9	0.8	129.7	0.8	109.8	0.8	23.3	0.8	76.4	68.0	0.9	3.4
135	413.2	0.6	298.5	0.7	221.7	0.7	172.5	0.7	194.9	0.8	134.7	0.8	114.0	0.8	23.3	0.8	79.3	70.5	0.9	3.4
140	428.6	0.6	309.5	0.7	229.9	0.7	178.9	0.7	202.9	0.8	139.7	0.8	118.2	0.8	23.3	0.8	82.3	73.0	0.9	3.4
145	443.9	0.6	320.6	0.7	238.1	0.7	185.3	0.7	210.9	0.8	144.6	0.8	122.4	0.8	23.3	0.8	85.2	75.5	0.9	3.4
150	459.2	0.6	331.7	0.7	246.3	0.7	191.6	0.7	218.9	0.8	149.6	0.8	126.7	0.8	23.3	0.8	88.2	78.0	0.9	3.4

RETARDANCE T<sub>r</sub> AND D

NOTE: Width and Depth dimensions are in feet; Velocity measurements are in feet per second; Depth T<sub>r</sub> does not include allowance for freeboard or settlement.

Table 6-39.2. Design Chart for Parallel Vegetated Dimension, Windway or Stormwater Conveyance  
 V1 FOR RETARDANCE T<sub>1</sub>, TOP WIDTH (T), DEPTH (D), AND V2 FOR RETARDANCE T<sub>2</sub>

Grade 0.25 Percent

Q CF3	V1-2.0		V1-2.5		V1-3.0		V1-3.5		V1-4.0		V1-4.5		V1-5.0		V1-5.5		V1-6.0	
	T	D	T	D	T	D	T	D	T	D	T	D	T	D	T	D	T	D
5																		
10																		
15																		
20																		
25																		
30																		
35																		
40																		
45																		
50																		
55																		
60																		
65																		
70																		
75																		
80																		
85																		
90																		
95																		
100																		
105																		
110																		
115																		
120																		
125																		
130																		
135																		
140																		
145																		
150																		

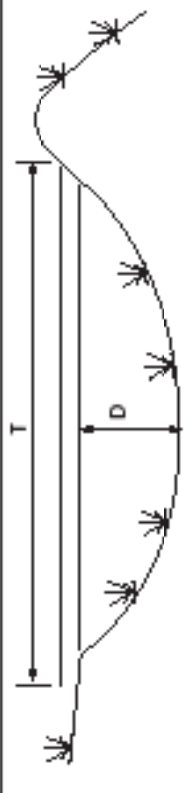

T = Top width, tall vegetation  
 D = Depth, tall vegetation  
 V2 = Design velocity, tall vegetation  
 V1 = Permissible velocity, short vegetation

RETARDANCE T<sub>1</sub> AND T<sub>2</sub>

NOTE: Width and Depth dimensions are in feet; Velocity measurements are in feet per second;  
 Depth T<sub>1</sub> does not include allowance for treatment or settlement.





Table 6-39.2. Design Chart for Parabolic Vegetated Diversion, Waterway or Stormwater Conveyance (Continued)  
 V1 FOR RETARDANCE T', TOP WIDTH (T), DEPTH (D), AND V2 FOR RETARDANCE T'

Grade 1.00 Percent

Q CFs	V1-2.0		V1-2.5		V1-3.0		V1-3.5		V1-4.0		V1-4.5		V1-5.0		V1-5.5		V1-6.0				
	T	D	T	D	T	D	T	D	T	D	T	D	T	D	T	D	T	D			
5																					
10	8.2	1.2	1.6	5.2	1.4	2.0															
15	12.6	1.1	1.6	8.7	1.3	2.1	5.5	1.6	2.6												
20	17.1	1.1	1.6	11.8	1.2	2.1	8.2	1.4	2.6												
25	21.4	1.1	1.6	14.9	1.2	2.1	10.5	1.4	2.6	7.3	1.6	3.1									
30	25.7	1.1	1.6	18.0	1.2	2.1	12.8	1.4	2.6	9.1	1.6	3.2									
35	29.9	1.1	1.6	21.2	1.2	2.1	15.0	1.3	2.6	10.9	1.5	3.1	7.8	1.8	3.7						
40	34.2	1.1	1.6	24.3	1.2	2.1	17.3	1.3	2.6	12.6	1.5	3.1	9.2	1.7	3.7						
45	38.5	1.1	1.6	27.3	1.2	2.1	19.5	1.3	2.6	14.3	1.5	3.1	10.6	1.7	3.7	7.2	2.2	4.3			
50	42.7	1.1	1.6	30.3	1.2	2.1	21.9	1.3	2.6	16.0	1.5	3.2	11.9	1.7	3.7	8.8	2.0	4.3			
55	47.0	1.1	1.6	33.3	1.2	2.1	24.1	1.3	2.6	17.7	1.5	3.2	13.3	1.7	3.7	9.9	1.9	4.3			
60	51.3	1.1	1.6	36.3	1.2	2.1	26.3	1.3	2.6	19.3	1.5	3.2	14.6	1.7	3.7	11.0	1.9	4.3			
65	55.5	1.1	1.6	39.4	1.2	2.1	28.5	1.3	2.6	21.0	1.5	3.2	15.9	1.6	3.7	12.1	1.9	4.3	8.0	2.5	4.9
70	59.8	1.1	1.6	42.4	1.2	2.1	30.7	1.3	2.6	22.7	1.5	3.2	17.1	1.6	3.7	13.2	1.9	4.3	9.5	2.3	4.8
75	64.1	1.1	1.6	45.4	1.2	2.1	32.9	1.3	2.6	24.6	1.5	3.1	18.5	1.6	3.7	14.2	1.8	4.3	10.4	2.2	4.9
80	68.3	1.1	1.6	48.4	1.2	2.1	35.0	1.3	2.6	26.2	1.5	3.1	19.8	1.6	3.7	15.2	1.8	4.3	11.3	2.2	4.9
85	72.6	1.1	1.6	51.5	1.2	2.1	37.2	1.3	2.6	27.9	1.5	3.1	21.0	1.6	3.7	16.3	1.8	4.3	12.1	2.2	4.9
90	76.9	1.1	1.6	54.5	1.2	2.1	39.4	1.3	2.6	29.5	1.5	3.1	22.3	1.6	3.7	17.3	1.8	4.3	13.0	2.1	4.9
95	81.1	1.1	1.6	57.5	1.2	2.1	41.6	1.3	2.6	31.1	1.5	3.1	23.6	1.6	3.7	18.3	1.8	4.3	13.8	2.1	4.9
100	85.4	1.1	1.6	60.5	1.2	2.1	43.8	1.3	2.6	32.7	1.5	3.1	24.9	1.6	3.7	19.3	1.8	4.3	14.6	2.1	4.9
105	89.7	1.1	1.6	63.6	1.2	2.1	46.0	1.3	2.6	34.4	1.5	3.1	26.5	1.6	3.7	20.3	1.8	4.3	15.4	2.1	4.9
110	94.0	1.1	1.6	66.6	1.2	2.1	48.2	1.3	2.6	36.0	1.5	3.1	27.7	1.6	3.7	21.3	1.8	4.3	16.2	2.1	4.9
115	98.2	1.1	1.6	69.6	1.2	2.1	50.4	1.3	2.6	37.6	1.5	3.1	29.0	1.6	3.7	22.3	1.8	4.3	17.0	2.1	4.9
120	102.5	1.1	1.6	72.6	1.2	2.1	52.5	1.3	2.6	39.3	1.5	3.1	30.2	1.6	3.7	23.3	1.8	4.3	17.9	2.1	4.9
125	106.8	1.1	1.6	75.7	1.2	2.1	54.7	1.3	2.6	40.9	1.5	3.1	31.5	1.6	3.7	24.3	1.8	4.3	18.7	2.1	4.9
130	111.0	1.1	1.6	78.7	1.2	2.1	56.9	1.3	2.6	42.5	1.5	3.1	32.7	1.6	3.7	25.3	1.8	4.3	19.4	2.1	4.9
135	115.3	1.1	1.6	81.7	1.2	2.1	59.1	1.3	2.6	44.2	1.5	3.1	34.0	1.6	3.7	26.3	1.8	4.3	20.2	2.0	4.9
140	119.6	1.1	1.6	84.7	1.2	2.1	61.3	1.3	2.6	45.8	1.5	3.1	35.2	1.6	3.7	27.3	1.8	4.3	21.0	2.0	4.9
145	123.8	1.1	1.6	87.8	1.2	2.1	63.5	1.3	2.6	47.5	1.5	3.1	36.5	1.6	3.7	28.7	1.8	4.3	21.8	2.0	4.9
150	128.1	1.1	1.6	90.8	1.2	2.1	65.7	1.3	2.6	49.1	1.5	3.1	37.8	1.6	3.7	29.7	1.8	4.3	22.6	2.0	4.9

RETARDANCE T' AND "C"

NOTE: Width and Depth dimensions are in feet. Velocity measurements are in feet per second.  
 Depth T' does not include allowance for freeboard or settlement.

Table 6-39.2. Design Chart for Parabolic Vegetated Diversion, Waterway or Stormwater Conveyance (Continued)  
 V1 FOR RETARDANCE "D", TOP WIDTH (T), DEPTH (D), AND V2 FOR RETARDANCE "C"

Grade 1.25 Percent

Q CFS	V1-2.0			V1-2.5			V1-3.0			V1-3.5			V1-4.0			V1-4.5			V1-5.0			V1-5.5			V1-6.0				
	T	D	V2	T	D	V2	T	D	V2	T	D	V2	T	D	V2	T	D	V2	T	D	V2	T	D	V2	T	D	V2	T	D
5	4.1	1.2	1.5																										
10	9.4	1.0	1.5	6.3	1.2	2.0																							
15	14.3	1.0	1.6	9.9	1.1	2.0	6.8	1.3	2.6																				
20	19.4	1.0	1.5	13.4	1.1	2.0	9.5	1.2	2.6	6.7	1.4	3.1																	
25	24.2	1.0	1.5	17.0	1.1	2.0	12.1	1.2	2.6	8.8	1.4	3.1	5.9	1.7	3.6														
30	29.0	1.0	1.6	20.4	1.1	2.0	14.6	1.2	2.6	10.7	1.4	3.1	7.8	1.6	3.7														
35	33.8	1.0	1.6	23.8	1.1	2.0	17.1	1.2	2.6	12.7	1.3	3.1	9.4	1.5	3.7	6.5	1.9	4.2											
40	38.6	1.0	1.6	27.1	1.1	2.0	19.8	1.2	2.5	14.6	1.3	3.1	10.9	1.5	3.7	8.1	1.7	4.2											
45	43.5	1.0	1.6	30.5	1.1	2.0	22.3	1.2	2.5	16.5	1.3	3.1	12.5	1.5	3.7	9.4	1.7	4.2											
50	48.3	1.0	1.6	33.9	1.1	2.0	24.8	1.2	2.5	18.3	1.3	3.1	13.9	1.5	3.7	10.6	1.7	4.2	7.7	2.0	4.8								
55	53.1	1.0	1.6	37.3	1.1	2.0	27.2	1.2	2.6	20.5	1.3	3.1	15.4	1.5	3.7	11.8	1.6	4.3	9.0	1.9	4.8								
60	57.9	1.0	1.6	40.7	1.1	2.0	29.7	1.2	2.6	22.3	1.3	3.1	16.9	1.5	3.7	13.0	1.6	4.3	10.1	1.9	4.8								
65	62.8	1.0	1.6	44.1	1.1	2.0	32.2	1.2	2.6	24.2	1.3	3.1	18.3	1.5	3.7	14.2	1.6	4.3	11.1	1.8	4.8	8.0	2.3	5.3					
70	67.6	1.0	1.6	47.5	1.1	2.0	34.6	1.2	2.6	26.0	1.3	3.1	19.8	1.4	3.7	15.4	1.6	4.3	12.0	1.8	4.8	9.3	2.1	5.3					
75	72.4	1.0	1.6	50.8	1.1	2.0	37.1	1.2	2.6	27.9	1.3	3.1	21.2	1.4	3.7	16.5	1.6	4.3	13.0	1.8	4.8	10.1	2.1	5.3					
80	77.2	1.0	1.6	54.2	1.1	2.0	39.6	1.2	2.6	29.7	1.3	3.1	23.0	1.4	3.6	17.7	1.6	4.3	14.0	1.8	4.8	11.0	2.0	5.3					
85	82.1	1.0	1.6	57.6	1.1	2.0	42.0	1.2	2.6	31.6	1.3	3.1	24.4	1.4	3.6	18.8	1.6	4.3	14.9	1.8	4.8	11.8	2.0	5.3					
90	86.9	1.0	1.6	61.0	1.1	2.0	44.5	1.2	2.6	33.5	1.3	3.1	25.8	1.4	3.6	20.0	1.6	4.3	15.9	1.8	4.8	12.6	2.0	5.3	9.1	2.5	5.9		
95	91.7	1.0	1.6	64.4	1.1	2.0	47.0	1.2	2.6	35.3	1.3	3.1	27.3	1.4	3.6	21.1	1.6	4.3	16.8	1.8	4.8	13.4	2.0	5.4	10.2	2.4	5.9		
100	96.6	1.0	1.6	67.8	1.1	2.0	49.4	1.2	2.6	37.2	1.3	3.1	28.7	1.4	3.6	22.3	1.6	4.3	17.7	1.8	4.8	14.2	2.0	5.4	10.9	2.3	5.9		
105	101.4	1.0	1.6	71.2	1.1	2.0	51.9	1.2	2.6	39.0	1.3	3.1	30.1	1.4	3.6	23.4	1.6	4.3	18.7	1.8	4.8	15.0	2.0	5.4	11.6	2.3	5.9		
110	106.2	1.0	1.6	74.6	1.1	2.0	54.4	1.2	2.6	40.9	1.3	3.1	31.6	1.4	3.6	24.6	1.6	4.3	19.6	1.7	4.8	15.8	2.0	5.4	12.3	2.3	5.9		
115	111.0	1.0	1.6	78.0	1.1	2.0	56.8	1.2	2.6	42.7	1.3	3.1	33.0	1.4	3.6	26.1	1.6	4.2	20.5	1.7	4.8	16.6	1.9	5.4	13.0	2.2	5.9		
120	115.9	1.0	1.6	81.3	1.1	2.0	59.3	1.2	2.6	44.6	1.3	3.1	34.4	1.4	3.6	27.2	1.6	4.2	21.5	1.7	4.8	17.3	1.9	5.4	13.6	2.2	5.9		
125	120.7	1.0	1.6	84.7	1.1	2.0	61.8	1.2	2.6	46.4	1.3	3.1	35.9	1.4	3.6	28.3	1.6	4.2	22.4	1.7	4.8	18.1	1.9	5.4	14.3	2.2	5.9		
130	125.5	1.0	1.6	88.1	1.1	2.0	64.3	1.2	2.6	48.3	1.3	3.1	37.3	1.4	3.7	29.5	1.6	4.2	23.3	1.7	4.8	18.9	1.9	5.4	14.9	2.2	5.9		
135	130.3	1.0	1.6	91.5	1.1	2.0	66.7	1.2	2.6	50.2	1.3	3.1	38.7	1.4	3.7	30.6	1.6	4.2	24.2	1.7	4.8	19.6	1.9	5.4	15.6	2.2	5.9		
140	135.2	1.0	1.6	94.9	1.1	2.0	69.2	1.2	2.6	52.0	1.3	3.1	40.2	1.4	3.7	31.7	1.6	4.2	25.1	1.7	4.8	20.4	1.9	5.4	16.2	2.2	5.9		
145	140.0	1.0	1.6	98.3	1.1	2.0	71.7	1.2	2.6	53.9	1.3	3.1	41.6	1.4	3.7	32.9	1.6	4.2	26.1	1.7	4.8	21.2	1.9	5.4	16.9	2.2	5.9		
150	144.8	1.0	1.6	101.7	1.1	2.0	74.1	1.2	2.6	55.7	1.3	3.1	43.0	1.4	3.7	34.0	1.6	4.2	27.0	1.7	4.8	21.9	1.9	5.4	17.5	2.2	5.9		

RETARDANCE "D" AND "C"

NOTE: Width and Depth dimensions are in feet. Velocity measurements are in feet per second.  
 Depth "D" does not include allowance for freeboard or settlement.



Table 6-39.2. Design Chart for Parabolic Vegetated Diversion, Wasteway or Stormwater Conveyance (Continued)  
 V1 FOR RETARDANCE "D", TOP WIDTH (T), DEPTH (D), AND V2 FOR RETARDANCE "C"  
 Grade 1.75 Percent

Q CFS	V1-2.0			V1-2.5			V1-3.0			V1-3.5			V1-4.0			V1-4.5			V1-5.0			V1-5.5			V1-6.0				
	T	D	V2	T	D	V2	T	D	V2	T	D	V2	T	D	V2	T	D	V2	T	D	V2	T	D	V2	T	D	V2	T	D
5	5.4	0.9	1.5																										
10	11.4	0.9	1.5	7.7	1.0	2.0	5.4	1.1	2.5																				
15	17.3	0.9	1.5	11.8	1.0	2.0	8.6	1.1	2.5	6.2	1.2	3.0																	
20	23.1	0.9	1.5	16.0	0.9	2.0	11.6	1.0	2.5	8.6	1.2	3.0	6.3	1.3	3.6														
25	28.8	0.9	1.5	20.0	0.9	2.0	14.6	1.0	2.5	10.9	1.1	3.0	8.2	1.3	3.6	5.9	1.5	4.1											
30	34.6	0.9	1.5	24.0	0.9	2.0	17.8	1.0	2.5	13.2	1.1	3.0	10.1	1.2	3.6	7.6	1.4	4.2											
35	40.3	0.9	1.5	28.0	0.9	2.0	20.7	1.0	2.5	15.5	1.1	3.0	11.9	1.2	3.6	9.1	1.4	4.2	6.9	1.6	4.7								
40	46.1	0.9	1.5	32.0	0.9	2.0	23.7	1.0	2.5	18.0	1.1	3.0	13.7	1.2	3.6	10.6	1.4	4.2	8.2	1.6	4.7								
45	51.9	0.9	1.5	36.0	0.9	2.0	26.6	1.0	2.5	20.2	1.1	3.0	15.4	1.2	3.6	12.0	1.3	4.2	9.4	1.5	4.7	7.0	1.8	5.3					
50	57.6	0.9	1.5	40.0	0.9	2.0	29.6	1.0	2.5	22.4	1.1	3.0	17.2	1.2	3.6	13.5	1.3	4.1	10.6	1.5	4.7	8.3	1.7	5.3					
55	63.4	0.9	1.5	44.0	0.9	2.0	32.5	1.0	2.5	24.7	1.1	3.0	19.2	1.2	3.6	14.9	1.3	4.1	11.8	1.5	4.7	9.3	1.7	5.3					
60	69.1	0.9	1.5	48.0	0.9	2.0	35.5	1.0	2.5	26.9	1.1	3.0	20.9	1.2	3.6	16.3	1.3	4.1	12.9	1.5	4.7	10.3	1.6	5.3	8.1	1.9	5.8		
65	74.9	0.9	1.5	52.0	0.9	2.0	38.4	1.0	2.5	29.2	1.1	3.0	22.7	1.2	3.6	17.7	1.3	4.1	14.1	1.5	4.7	11.3	1.6	5.3	9.0	1.9	5.8		
70	80.7	0.9	1.5	56.0	0.9	2.0	41.4	1.0	2.5	31.4	1.1	3.0	24.4	1.2	3.6	19.1	1.3	4.1	15.2	1.5	4.7	12.3	1.6	5.3	9.8	1.8	5.8		
75	86.4	0.9	1.5	60.0	0.9	2.0	44.3	1.0	2.5	33.6	1.1	3.0	26.1	1.2	3.6	20.5	1.3	4.1	16.4	1.4	4.7	13.2	1.6	5.3	10.7	1.8	5.8		
80	92.2	0.9	1.5	63.9	0.9	2.0	47.3	1.0	2.5	35.9	1.1	3.0	27.9	1.2	3.6	22.2	1.3	4.1	17.5	1.4	4.7	14.2	1.6	5.3	11.5	1.8	5.8		
85	97.9	0.9	1.5	67.9	0.9	2.0	50.2	1.0	2.5	38.1	1.1	3.0	29.6	1.2	3.6	23.5	1.3	4.1	18.6	1.4	4.7	15.1	1.6	5.3	12.3	1.8	5.8		
90	103.7	0.9	1.5	71.9	0.9	2.0	53.2	1.0	2.5	40.3	1.1	3.0	31.4	1.2	3.6	24.9	1.3	4.1	19.8	1.4	4.7	16.1	1.6	5.3	13.1	1.8	5.8		
95	109.5	0.9	1.5	75.9	0.9	2.0	56.1	1.0	2.5	42.6	1.1	3.0	33.1	1.2	3.6	26.3	1.3	4.1	20.9	1.4	4.7	17.0	1.6	5.3	13.9	1.7	5.8		
100	115.2	0.9	1.5	79.9	0.9	2.0	59.1	1.0	2.5	44.8	1.1	3.0	34.8	1.2	3.6	27.7	1.3	4.1	22.0	1.4	4.7	17.9	1.6	5.3	14.7	1.7	5.8		
105	121.0	0.9	1.5	83.9	0.9	2.0	62.0	1.0	2.5	47.1	1.1	3.0	36.6	1.2	3.6	29.0	1.3	4.1	23.4	1.4	4.7	18.9	1.6	5.3	15.5	1.7	5.8		
110	126.8	0.9	1.5	87.9	0.9	2.0	65.0	1.0	2.5	49.3	1.1	3.0	38.3	1.2	3.6	30.4	1.3	4.1	24.5	1.4	4.7	19.8	1.6	5.3	16.3	1.7	5.8		
115	132.5	0.9	1.5	91.9	0.9	2.0	67.9	1.0	2.5	51.5	1.1	3.0	40.1	1.2	3.6	31.8	1.3	4.1	25.6	1.4	4.7	20.7	1.6	5.3	17.1	1.7	5.9		
120	138.3	0.9	1.5	95.9	0.9	2.0	70.9	1.0	2.5	53.8	1.1	3.0	41.8	1.2	3.6	33.2	1.3	4.1	26.8	1.4	4.7	21.7	1.6	5.3	17.9	1.7	5.9		
125	144.0	0.9	1.5	99.9	0.9	2.0	73.8	1.0	2.5	56.0	1.1	3.0	43.5	1.2	3.6	34.6	1.3	4.1	27.9	1.4	4.7	22.6	1.6	5.3	18.7	1.7	5.9		
130	149.8	0.9	1.5	103.9	0.9	2.0	76.8	1.0	2.5	58.3	1.1	3.0	45.3	1.2	3.6	35.9	1.3	4.1	29.0	1.4	4.7	23.5	1.6	5.3	19.4	1.7	5.9		
135	155.6	0.9	1.5	107.9	0.9	2.0	79.7	1.0	2.5	60.5	1.1	3.0	47.0	1.2	3.6	37.3	1.3	4.1	30.1	1.4	4.7	24.5	1.6	5.3	20.2	1.7	5.9		
140	161.3	0.9	1.5	111.9	0.9	2.0	82.7	1.0	2.5	62.7	1.1	3.0	48.8	1.2	3.6	38.7	1.3	4.1	31.2	1.4	4.7	25.7	1.6	5.3	21.0	1.7	5.9		
145	167.1	0.9	1.5	115.9	0.9	2.0	85.6	1.0	2.5	65.0	1.1	3.0	50.5	1.2	3.6	40.1	1.3	4.1	32.3	1.4	4.7	26.6	1.6	5.3	21.8	1.7	5.9		
150	172.8	0.9	1.5	119.9	0.9	2.0	88.6	1.0	2.5	67.2	1.1	3.0	52.2	1.2	3.6	41.5	1.3	4.1	33.4	1.4	4.7	27.5	1.6	5.3	22.6	1.7	5.9		

RETARDANCE "D" AND "C"

NOTE: Width and Depth dimensions are in feet. Velocity measurements are in feet per second.  
 Depth "D" does not include allowance for freeboard or settlement.



Table 6-39.2. Design Chart for Parabolic Vegetated Diversion, Waterway or Stormwater Conveyance (Continued)  
 V1 FOR RETARDANCE T', TOP WIDTH (T), DEPTH (D), AND V2 FOR RETARDANCE T'

Grade 2.00 Percent

Q CFR	V1-2.0		V1-2.5		V1-3.0		V1-3.5		V1-4.0		V1-4.5		V1-5.0		V1-5.5		V1-6.0		
	T	D	T	D	T	D	T	D	T	D	T	D	T	D	T	D	T	D	
5	5.9	0.9	1.5																
10	12.4	0.8	1.5	8.1	0.9	2.0	5.9	1.0	2.5										
15	18.5	0.8	1.5	12.3	0.9	2.0	9.3	1.0	2.5	6.8	1.1	3.0	4.7	1.4	3.5				
20	24.7	0.8	1.5	16.7	0.9	2.0	12.5	1.0	2.5	9.4	1.1	3.0	7.0	1.2	3.6	4.7	1.5	4.1	
25	30.8	0.8	1.5	20.8	0.9	2.0	15.9	1.0	2.4	11.8	1.1	3.0	9.0	1.2	3.5	6.8	1.3	4.1	
30	37.0	0.8	1.5	25.0	0.9	2.0	19.0	1.0	2.5	14.3	1.1	3.0	11.0	1.2	3.5	8.5	1.3	4.1	6.4
35	43.2	0.8	1.5	29.1	0.9	2.0	22.2	1.0	2.5	16.9	1.0	3.0	12.9	1.1	3.5	10.1	1.3	4.1	7.8
40	49.3	0.8	1.5	33.3	0.9	2.0	25.3	1.0	2.5	19.3	1.0	3.0	14.8	1.1	3.5	11.6	1.3	4.1	9.1
45	55.5	0.8	1.5	37.4	0.9	2.0	28.5	1.0	2.5	21.7	1.0	3.0	16.7	1.1	3.5	13.1	1.3	4.1	10.4
50	61.7	0.8	1.5	41.6	0.9	2.0	31.7	1.0	2.5	24.1	1.0	3.0	18.8	1.1	3.5	14.7	1.2	4.1	11.7
55	67.8	0.8	1.5	45.7	0.9	2.0	34.8	1.0	2.5	26.5	1.0	3.0	20.7	1.1	3.5	16.2	1.2	4.1	12.9
60	74.0	0.8	1.5	49.9	0.9	2.0	38.0	1.0	2.5	28.9	1.0	3.0	22.6	1.1	3.5	17.7	1.2	4.1	14.1
65	80.2	0.8	1.5	54.0	0.9	2.0	41.1	1.0	2.5	31.4	1.0	3.0	24.5	1.1	3.5	19.5	1.2	4.1	15.4
70	86.3	0.8	1.5	58.2	0.9	2.0	44.3	1.0	2.5	33.8	1.0	3.0	26.3	1.1	3.5	21.0	1.2	4.1	16.6
75	92.5	0.8	1.5	62.3	0.9	2.0	47.5	1.0	2.5	36.2	1.0	3.0	28.2	1.1	3.5	22.4	1.2	4.1	17.8
80	98.7	0.8	1.5	66.5	0.9	2.0	50.6	1.0	2.5	38.6	1.0	3.0	30.1	1.1	3.5	23.9	1.2	4.1	19.0
85	104.8	0.8	1.5	70.6	0.9	2.0	53.8	1.0	2.5	41.0	1.0	3.0	32.0	1.1	3.5	25.4	1.2	4.1	20.3
90	111.0	0.8	1.5	74.8	0.9	2.0	57.0	1.0	2.5	43.4	1.0	3.0	33.8	1.1	3.5	26.9	1.2	4.1	21.8
95	117.2	0.8	1.5	78.9	0.9	2.0	60.1	1.0	2.5	45.8	1.0	3.0	35.7	1.1	3.5	28.4	1.2	4.1	23.0
100	123.3	0.8	1.5	83.1	0.9	2.0	63.3	1.0	2.5	48.2	1.0	3.0	37.6	1.1	3.5	29.9	1.2	4.1	24.2
105	129.5	0.8	1.5	87.3	0.9	2.0	66.4	1.0	2.5	50.6	1.0	3.0	39.5	1.1	3.5	31.4	1.2	4.1	25.4
110	135.7	0.8	1.5	91.4	0.9	2.0	69.6	1.0	2.5	53.0	1.0	3.0	41.3	1.1	3.5	32.9	1.2	4.1	26.6
115	141.8	0.8	1.5	95.6	0.9	2.0	72.8	1.0	2.5	55.4	1.0	3.0	43.2	1.1	3.5	34.4	1.2	4.1	27.9
120	148.0	0.8	1.5	99.7	0.9	2.0	75.9	1.0	2.5	57.9	1.0	3.0	45.1	1.1	3.5	35.9	1.2	4.1	29.1
125	154.1	0.8	1.5	103.9	0.9	2.0	79.1	1.0	2.5	60.3	1.0	3.0	47.0	1.1	3.5	37.4	1.2	4.1	30.3
130	160.3	0.8	1.5	108.0	0.9	2.0	82.3	1.0	2.5	62.7	1.0	3.0	48.8	1.1	3.5	38.9	1.2	4.1	31.5
135	166.5	0.8	1.5	112.2	0.9	2.0	85.4	1.0	2.5	65.1	1.0	3.0	50.7	1.1	3.5	40.3	1.2	4.1	32.7
140	172.6	0.8	1.5	116.3	0.9	2.0	88.6	1.0	2.5	67.5	1.0	3.0	52.6	1.1	3.5	41.8	1.2	4.1	33.9
145	178.8	0.8	1.5	120.5	0.9	2.0	91.8	1.0	2.5	69.9	1.0	3.0	54.5	1.1	3.5	43.3	1.2	4.1	35.1
150	185.0	0.8	1.5	124.6	0.9	2.0	94.9	1.0	2.5	72.3	1.0	3.0	56.4	1.1	3.5	44.8	1.2	4.1	36.3

RETARDANCE T' AND "C"

NOTE: Width and Depth dimensions are in feet; Velocity measurements are in feet per second; Depth T' does not include allowance for freeboard or settlement.



Table 6-39.2. Design Chart for Parabolic Vegetated Diversion, Waterway or Stormwater Conveyance (Continued)  
 V1 FOR RETARDANCE T', TOP WIDTH (T), DEPTH (D), AND V2 FOR RETARDANCE T'

Grade 4.00 Percent

Q CFR	V1-2.0		V1-2.5		V1-3.0		V1-3.5		V1-4.0		V1-4.5		V1-5.0		V1-5.5		V1-6.0	
	T	D	T	D	T	D	T	D	T	D	T	D	T	D	T	D	T	D
5	8.5	0.6	1.4	5.9	0.7	1.8	4.1	0.8	2.3									
10	17.2	0.6	1.4	12.1	0.7	1.8	8.8	0.7	2.3	6.7	0.8	2.8	5.2	0.9	3.3	3.8	1.0	3.9
15	25.8	0.6	1.4	18.1	0.7	1.8	13.4	0.7	2.3	10.3	0.8	2.8	8.1	0.8	3.4	6.4	0.9	3.9
20	34.4	0.6	1.4	24.2	0.7	1.8	17.8	0.7	2.3	13.9	0.8	2.8	10.9	0.8	3.4	8.7	0.9	3.9
25	43.0	0.6	1.4	30.2	0.7	1.9	22.3	0.7	2.3	17.4	0.8	2.8	13.8	0.8	3.3	10.9	0.9	3.9
30	51.6	0.6	1.4	36.3	0.7	1.9	26.7	0.7	2.3	20.8	0.8	2.8	16.5	0.8	3.3	13.2	0.9	3.9
35	60.2	0.6	1.4	42.3	0.7	1.9	31.1	0.7	2.3	24.3	0.8	2.8	19.3	0.8	3.4	15.6	0.9	3.9
40	68.8	0.6	1.4	48.3	0.7	1.9	35.6	0.7	2.3	27.8	0.8	2.8	22.0	0.8	3.4	17.8	0.9	3.9
45	77.4	0.6	1.4	54.4	0.7	1.9	40.0	0.7	2.4	31.2	0.8	2.8	24.8	0.8	3.4	20.0	0.9	3.9
50	86.0	0.6	1.4	60.4	0.7	1.9	44.5	0.7	2.4	34.7	0.8	2.8	27.5	0.8	3.4	22.2	0.9	3.9
55	94.6	0.6	1.4	66.5	0.7	1.9	48.9	0.7	2.4	38.2	0.8	2.8	30.3	0.8	3.4	24.4	0.9	3.9
60	103.2	0.6	1.4	72.5	0.7	1.9	53.4	0.7	2.4	41.7	0.8	2.8	33.0	0.8	3.4	26.6	0.9	3.9
65	111.8	0.6	1.4	78.5	0.7	1.9	57.8	0.7	2.4	45.1	0.8	2.8	35.8	0.8	3.4	28.9	0.9	3.9
70	120.4	0.6	1.4	84.6	0.7	1.9	62.3	0.7	2.4	48.6	0.8	2.8	38.6	0.8	3.4	31.1	0.9	3.9
75	129.0	0.6	1.4	90.6	0.7	1.9	66.7	0.7	2.4	52.1	0.8	2.8	41.3	0.8	3.4	33.3	0.9	3.9
80	137.6	0.6	1.4	96.7	0.7	1.9	71.2	0.7	2.4	55.5	0.8	2.8	44.1	0.8	3.4	35.5	0.9	3.9
85	146.2	0.6	1.4	102.7	0.7	1.9	75.6	0.7	2.4	59.0	0.8	2.8	46.8	0.8	3.4	37.7	0.9	3.9
90	154.8	0.6	1.4	108.7	0.7	1.9	80.0	0.7	2.4	62.5	0.8	2.8	49.6	0.8	3.4	39.9	0.9	3.9
95	163.4	0.6	1.4	114.8	0.7	1.9	84.5	0.7	2.4	65.9	0.8	2.8	52.3	0.8	3.4	42.2	0.9	3.9
100	172.0	0.6	1.4	120.8	0.7	1.9	88.9	0.7	2.4	69.4	0.8	2.8	55.1	0.8	3.4	44.4	0.9	3.9
105	180.6	0.6	1.4	126.9	0.7	1.9	93.4	0.7	2.4	72.9	0.8	2.8	57.8	0.8	3.4	46.6	0.9	3.9
110	189.2	0.6	1.4	132.9	0.7	1.9	97.8	0.7	2.4	76.3	0.8	2.8	60.6	0.8	3.4	48.8	0.9	3.9
115	197.8	0.6	1.4	138.9	0.7	1.9	102.3	0.7	2.4	79.8	0.8	2.8	63.3	0.8	3.4	51.0	0.9	3.9
120	206.4	0.6	1.4	145.0	0.7	1.9	106.7	0.7	2.4	83.3	0.8	2.8	66.1	0.8	3.4	53.3	0.9	3.9
125	215.0	0.6	1.4	151.0	0.7	1.9	111.2	0.7	2.4	86.8	0.8	2.8	68.8	0.8	3.4	55.5	0.9	3.9
130	223.7	0.6	1.4	157.1	0.7	1.9	115.6	0.7	2.4	90.2	0.8	2.8	71.6	0.8	3.4	57.7	0.9	3.9
135	232.3	0.6	1.4	163.1	0.7	1.9	120.1	0.7	2.4	93.7	0.8	2.8	74.3	0.8	3.4	59.9	0.9	3.9
140	240.9	0.6	1.4	169.1	0.7	1.9	124.5	0.7	2.4	97.2	0.8	2.8	77.1	0.8	3.4	62.1	0.9	3.9
145	249.5	0.6	1.4	175.2	0.7	1.9	129.0	0.7	2.4	100.6	0.8	2.8	79.8	0.8	3.4	64.3	0.9	3.9
150	258.1	0.6	1.4	181.2	0.7	1.9	133.4	0.7	2.4	104.1	0.8	2.8	82.6	0.8	3.4	66.6	0.9	3.9

RETARDANCE T' AND "C"

NOTE: Width and Depth dimensions are in feet; Velocity measurements are in feet per second; Depth T' does not include allowance for freeboard or settlement.

Table 6-39.2. Design Chart for Parabolic Vegetated Diversion, Waterway or Stormwater Conveyance (Continued)  
 V1 FOR RETARDANCE T\*, TOP WIDTH (T), DEPTH (D), AND V2 FOR RETARDANCE V\*

Grade 5.00 Percent

Q CFS	V1-2.0		V1-2.5		V1-3.0		V1-3.5		V1-4.0		V1-4.5		V1-5.0		V1-5.5		V1-6.0										
	T	D	T	D	T	D	T	D	T	D	T	D	T	D	T	D	T	D									
5	9.5	0.6	1.4	6.7	0.6	1.8	4.7	0.7	2.3	3.5	0.8	2.8															
10	19.0	0.6	1.4	13.7	0.6	1.8	9.7	0.7	2.3	7.6	0.7	2.8	6.0	0.8	3.3	4.7	0.8	3.8	3.4	1.0	4.4						
15	28.5	0.6	1.4	20.5	0.6	1.8	14.8	0.7	2.3	11.7	0.7	2.8	9.2	0.7	3.3	7.3	0.8	3.8	5.9	0.9	4.4	4.7	1.0	5.0			
20	38.0	0.6	1.4	27.3	0.6	1.8	19.7	0.7	2.3	15.5	0.7	2.8	12.4	0.7	3.3	9.9	0.8	3.8	8.0	0.9	4.4	6.5	0.9	4.9	5.3	1.0	5.5
25	47.5	0.6	1.4	34.1	0.6	1.8	24.6	0.7	2.3	19.4	0.7	2.8	15.5	0.7	3.3	12.6	0.8	3.8	10.1	0.8	4.4	8.3	0.9	5.0	6.8	1.0	5.6
30	57.0	0.6	1.4	40.9	0.6	1.8	29.5	0.7	2.3	23.3	0.7	2.8	18.6	0.7	3.3	15.1	0.8	3.8	12.2	0.8	4.4	10.1	0.9	5.0	8.3	1.0	5.6
35	66.5	0.6	1.4	47.7	0.6	1.8	34.4	0.7	2.3	27.2	0.7	2.8	21.7	0.7	3.3	17.6	0.8	3.8	14.5	0.8	4.4	11.8	0.9	5.0	9.8	1.0	5.6
40	76.0	0.6	1.4	54.6	0.6	1.8	39.4	0.7	2.3	31.0	0.7	2.8	24.8	0.7	3.3	20.1	0.8	3.8	16.5	0.8	4.4	13.6	0.9	5.0	11.3	1.0	5.5
45	85.5	0.6	1.4	61.4	0.6	1.8	44.3	0.7	2.3	34.9	0.7	2.8	27.9	0.7	3.3	22.6	0.8	3.8	18.6	0.8	4.4	15.5	0.9	4.9	12.8	1.0	5.5
50	95.0	0.6	1.4	68.2	0.6	1.8	49.2	0.7	2.3	38.8	0.7	2.8	31.0	0.7	3.3	25.1	0.8	3.8	20.6	0.8	4.4	17.2	0.9	4.9	14.3	1.0	5.5
55	104.6	0.6	1.4	75.0	0.6	1.8	54.1	0.7	2.3	42.7	0.7	2.8	34.1	0.7	3.3	27.6	0.8	3.8	22.7	0.8	4.4	18.9	0.9	4.9	15.9	0.9	5.5
60	114.1	0.6	1.4	81.8	0.6	1.8	59.0	0.7	2.3	46.6	0.7	2.8	37.2	0.7	3.3	30.1	0.8	3.8	24.7	0.8	4.4	20.6	0.9	4.9	17.3	0.9	5.5
65	123.6	0.6	1.4	88.6	0.6	1.8	63.9	0.7	2.3	50.4	0.7	2.8	40.3	0.7	3.3	32.6	0.8	3.8	26.8	0.8	4.4	22.3	0.9	4.9	18.8	0.9	5.5
70	133.1	0.6	1.4	95.5	0.6	1.8	68.9	0.7	2.3	54.3	0.7	2.8	43.4	0.7	3.3	35.1	0.8	3.8	28.9	0.8	4.4	24.0	0.9	4.9	20.2	0.9	5.5
75	142.6	0.6	1.4	102.3	0.6	1.8	73.8	0.7	2.3	58.2	0.7	2.8	46.5	0.7	3.3	37.7	0.8	3.8	30.9	0.8	4.4	25.7	0.9	4.9	21.6	0.9	5.5
80	152.1	0.6	1.4	109.1	0.6	1.8	78.7	0.7	2.3	62.1	0.7	2.8	49.6	0.7	3.3	40.2	0.8	3.8	33.0	0.8	4.4	27.4	0.9	4.9	23.1	0.9	5.5
85	161.6	0.6	1.4	115.9	0.6	1.8	83.6	0.7	2.3	65.9	0.7	2.8	52.7	0.7	3.3	42.7	0.8	3.8	35.0	0.8	4.4	29.1	0.9	5.0	24.5	0.9	5.5
90	171.1	0.6	1.4	122.7	0.6	1.8	88.5	0.7	2.3	69.8	0.7	2.8	55.8	0.7	3.3	45.2	0.8	3.8	37.1	0.8	4.4	30.9	0.9	5.0	26.0	0.9	5.5
95	180.6	0.6	1.4	129.6	0.6	1.8	93.4	0.7	2.3	73.7	0.7	2.8	58.9	0.7	3.3	47.7	0.8	3.8	39.2	0.8	4.4	32.6	0.9	5.0	27.4	0.9	5.5
100	190.1	0.6	1.4	136.4	0.6	1.8	98.4	0.7	2.3	77.6	0.7	2.8	62.0	0.7	3.3	50.2	0.8	3.8	41.2	0.8	4.4	34.3	0.9	5.0	28.8	0.9	5.5
105	199.6	0.6	1.4	143.2	0.6	1.8	103.3	0.7	2.3	81.5	0.7	2.8	65.1	0.7	3.3	52.7	0.8	3.8	43.3	0.8	4.4	36.0	0.9	5.0	30.3	0.9	5.5
110	209.1	0.6	1.4	150.0	0.6	1.8	108.2	0.7	2.3	85.3	0.7	2.8	68.2	0.7	3.3	55.2	0.8	3.8	45.3	0.8	4.4	37.7	0.9	5.0	31.7	0.9	5.5
115	218.6	0.6	1.4	156.8	0.6	1.8	113.1	0.7	2.3	89.2	0.7	2.8	71.3	0.7	3.3	57.7	0.8	3.8	47.4	0.8	4.4	39.4	0.9	5.0	33.2	0.9	5.5
120	228.1	0.6	1.4	163.6	0.6	1.8	118.0	0.7	2.3	93.1	0.7	2.8	74.3	0.7	3.3	60.2	0.8	3.8	49.5	0.8	4.4	41.1	0.9	5.0	34.6	0.9	5.5
125	237.6	0.6	1.4	170.5	0.6	1.8	123.0	0.7	2.3	97.0	0.7	2.8	77.4	0.7	3.3	62.7	0.8	3.8	51.5	0.8	4.4	42.8	0.9	5.0	36.0	0.9	5.5
130	247.1	0.6	1.4	177.3	0.6	1.8	127.9	0.7	2.3	100.8	0.7	2.8	80.5	0.7	3.3	65.2	0.8	3.8	53.6	0.8	4.4	44.6	0.9	5.0	37.5	0.9	5.5
135	256.6	0.6	1.4	184.1	0.6	1.8	132.8	0.7	2.3	104.7	0.7	2.8	83.6	0.7	3.3	67.8	0.8	3.8	55.6	0.8	4.4	46.3	0.9	5.0	38.9	0.9	5.5
140	266.1	0.6	1.4	190.9	0.6	1.8	137.7	0.7	2.3	108.6	0.7	2.8	86.7	0.7	3.3	70.3	0.8	3.8	57.7	0.8	4.4	48.0	0.9	5.0	40.4	0.9	5.5
145	275.6	0.6	1.4	197.7	0.6	1.8	142.6	0.7	2.3	112.5	0.7	2.8	89.8	0.7	3.3	72.8	0.8	3.8	59.8	0.8	4.4	49.7	0.9	5.0	41.8	0.9	5.5
150	285.1	0.6	1.4	204.6	0.6	1.8	147.5	0.7	2.3	116.4	0.7	2.8	92.9	0.7	3.3	75.3	0.8	3.8	61.8	0.8	4.4	51.4	0.9	5.0	43.2	0.9	5.5

RETARDANCE T\* AND V\*

NOTE: Width and Depth dimensions are in feet; Velocity measurements are in feet per second; Depth T\* does not include allowance for freeboard or settlement.

Table 6-39.2. Design Chart for Parabolic Vegetated Diversion, Waterway or Stormwater Conveyance (Continued)  
 V1 FOR RETARDANCE T\*, TOP WIDTH (T), DEPTH (D), AND V2 FOR RETARDANCE T\*

Grade 6.00 Percent

Q CFs	V1-2.0		V1-2.5		V1-3.0		V1-3.5		V1-4.0		V1-4.5		V1-5.0		V1-5.5		V1-6.0										
	T	D	T	D	T	D	T	D	T	D	T	D	T	D	T	D	T	D									
5	10.6	0.5	1.3	7.3	0.6	1.8	5.3	0.6	2.3	4.0	0.7	2.8	2.9	0.8	3.2												
10	21.1	0.5	1.3	14.7	0.6	1.8	10.9	0.6	2.3	8.4	0.7	2.8	6.6	0.7	3.2	5.3	0.8	3.8	4.2	0.8	4.3						
15	31.6	0.5	1.3	22.1	0.6	1.8	16.3	0.6	2.3	12.7	0.6	2.7	10.1	0.7	3.3	8.2	0.7	3.8	6.6	0.8	4.3	5.4	0.9	4.9	4.3	1.0	5.5
20	42.1	0.5	1.3	29.5	0.6	1.8	21.7	0.6	2.3	17.0	0.6	2.7	13.6	0.7	3.2	11.1	0.7	3.7	9.0	0.8	4.3	7.4	0.8	4.9	6.1	0.9	5.5
25	52.7	0.5	1.3	36.8	0.6	1.8	27.1	0.6	2.3	21.2	0.6	2.8	17.0	0.7	3.2	13.9	0.7	3.8	11.3	0.8	4.3	9.3	0.8	4.9	7.8	0.9	5.5
30	63.2	0.5	1.3	44.2	0.6	1.8	32.5	0.6	2.3	25.4	0.6	2.8	20.4	0.7	3.2	16.6	0.7	3.8	13.7	0.8	4.3	11.3	0.8	4.9	9.4	0.9	5.5
35	73.7	0.5	1.3	51.6	0.6	1.8	38.0	0.6	2.3	29.7	0.6	2.8	23.8	0.7	3.2	19.4	0.7	3.8	16.0	0.8	4.3	13.4	0.8	4.9	11.1	0.9	5.5
40	84.2	0.5	1.3	59.9	0.6	1.8	43.4	0.6	2.3	33.9	0.6	2.8	27.2	0.7	3.3	22.2	0.7	3.8	18.3	0.8	4.3	15.3	0.8	4.9	12.7	0.9	5.5
45	94.8	0.5	1.3	66.3	0.6	1.8	48.8	0.6	2.3	38.2	0.6	2.8	30.7	0.7	3.3	24.9	0.7	3.8	20.6	0.8	4.3	17.2	0.8	4.9	14.5	0.9	5.4
50	105.3	0.5	1.3	73.6	0.6	1.8	54.2	0.6	2.3	42.4	0.6	2.8	34.1	0.7	3.3	27.7	0.7	3.8	22.8	0.8	4.3	19.1	0.8	4.9	16.1	0.9	5.4
55	115.8	0.5	1.3	81.0	0.6	1.8	59.7	0.6	2.3	46.6	0.6	2.8	37.5	0.7	3.3	30.5	0.7	3.8	25.1	0.8	4.3	21.0	0.8	4.9	17.7	0.9	5.4
60	126.4	0.5	1.3	88.4	0.6	1.8	65.1	0.6	2.3	50.9	0.6	2.8	40.9	0.7	3.3	33.3	0.7	3.8	27.4	0.8	4.3	22.9	0.8	4.9	19.3	0.9	5.4
65	136.9	0.5	1.3	95.7	0.6	1.8	70.5	0.6	2.3	55.1	0.6	2.8	44.3	0.7	3.3	36.0	0.7	3.8	29.7	0.8	4.3	24.8	0.8	4.9	20.9	0.9	5.4
70	147.4	0.5	1.3	103.1	0.6	1.8	75.9	0.6	2.3	59.3	0.6	2.8	47.7	0.7	3.3	38.8	0.7	3.8	32.0	0.8	4.3	26.7	0.8	4.9	22.5	0.9	5.4
75	158.0	0.5	1.3	110.5	0.6	1.8	81.3	0.6	2.3	63.6	0.6	2.8	51.1	0.7	3.3	41.6	0.7	3.8	34.3	0.8	4.3	28.6	0.8	4.9	24.1	0.9	5.4
80	168.5	0.5	1.3	117.8	0.6	1.8	86.8	0.6	2.3	67.8	0.6	2.8	54.5	0.7	3.3	44.3	0.7	3.8	36.5	0.8	4.3	30.5	0.8	4.9	25.7	0.9	5.5
85	179.0	0.5	1.3	125.2	0.6	1.8	92.2	0.6	2.3	72.0	0.6	2.8	57.9	0.7	3.3	47.1	0.7	3.8	38.8	0.8	4.3	32.4	0.8	4.9	27.3	0.9	5.5
90	189.6	0.5	1.3	132.6	0.6	1.8	97.6	0.6	2.3	76.3	0.6	2.8	61.3	0.7	3.3	49.9	0.7	3.8	41.1	0.8	4.3	34.3	0.8	4.9	28.9	0.9	5.5
95	200.1	0.5	1.3	139.9	0.6	1.8	103.0	0.6	2.3	80.5	0.6	2.8	64.7	0.7	3.3	52.6	0.7	3.8	43.4	0.8	4.3	36.2	0.8	4.9	30.5	0.9	5.5
100	210.6	0.5	1.3	147.3	0.6	1.8	108.5	0.6	2.3	84.8	0.6	2.8	68.1	0.7	3.3	55.4	0.7	3.8	45.7	0.8	4.3	38.1	0.8	4.9	32.1	0.9	5.5
105	221.1	0.5	1.3	154.6	0.6	1.8	113.9	0.6	2.3	89.0	0.6	2.8	71.5	0.7	3.3	58.2	0.7	3.8	47.9	0.8	4.3	40.0	0.8	4.9	33.7	0.9	5.5
110	231.7	0.5	1.3	162.0	0.6	1.8	119.3	0.6	2.3	93.2	0.6	2.8	74.9	0.7	3.3	60.9	0.7	3.8	50.2	0.8	4.3	41.9	0.8	4.9	35.3	0.9	5.5
115	242.2	0.5	1.3	169.4	0.6	1.8	124.7	0.6	2.3	97.5	0.6	2.8	78.3	0.7	3.3	63.7	0.7	3.8	52.5	0.8	4.3	43.8	0.8	4.9	36.9	0.9	5.5
120	252.7	0.5	1.3	176.7	0.6	1.8	130.2	0.6	2.3	101.7	0.6	2.8	81.7	0.7	3.3	66.5	0.7	3.8	54.8	0.8	4.3	45.7	0.8	4.9	38.5	0.9	5.5
125	263.3	0.5	1.3	184.1	0.6	1.8	135.6	0.6	2.3	106.0	0.6	2.8	85.1	0.7	3.3	69.3	0.7	3.8	57.1	0.8	4.3	47.6	0.8	4.9	40.1	0.9	5.5
130	273.8	0.5	1.3	191.5	0.6	1.8	141.0	0.6	2.3	110.2	0.6	2.8	88.5	0.7	3.3	72.0	0.7	3.8	59.4	0.8	4.3	49.5	0.8	4.9	41.7	0.9	5.5
135	284.3	0.5	1.3	198.8	0.6	1.8	146.4	0.6	2.3	114.4	0.6	2.8	91.9	0.7	3.3	74.8	0.7	3.8	61.6	0.8	4.3	51.4	0.8	4.9	43.3	0.9	5.5
140	294.9	0.5	1.3	206.2	0.6	1.8	151.8	0.6	2.3	118.7	0.6	2.8	96.3	0.7	3.3	77.6	0.7	3.8	63.9	0.8	4.3	53.3	0.8	4.9	44.9	0.9	5.5
145	305.4	0.5	1.3	213.6	0.6	1.8	157.3	0.6	2.3	122.9	0.6	2.8	98.7	0.7	3.3	80.3	0.7	3.8	66.2	0.8	4.3	55.2	0.8	4.9	46.5	0.9	5.5
150	315.9	0.5	1.3	220.9	0.6	1.8	162.7	0.6	2.3	127.1	0.6	2.8	102.1	0.7	3.3	83.1	0.7	3.8	68.5	0.8	4.3	57.1	0.8	4.9	48.1	0.9	5.5

RETARDANCE T\* AND "C"

NOTE: Width and Depth dimensions are in feet; Velocity measurements are in feet per second; Depth T\* does not include allowance for freeboard or settlement.

Table 6-39.2. Design Chart for Parabolic Vegetated Diversion, Waterway or Stormwater Conveyance (Continued)  
 V1 FOR RETARDANCE 'D', TOP WIDTH (T), DEPTH (D), AND V2 FOR RETARDANCE 'C'

Grade 8.00 Percent

Q CFS	V1-2.0		V1-2.5		V1-3.0		V1-3.5		V1-4.0		V1-4.5		V1-5.0		V1-5.5		V1-6.0		
	T	D	T	D	T	D	T	D	T	D	T	D	T	D	T	D	T	D	
5	12.0	0.5	1.7	8.5	0.5	2.2	4.6	0.6	2.7	3.7	0.6	3.2	2.9	0.7	3.6				
10	24.1	0.5	1.7	16.9	0.5	2.2	9.6	0.6	2.7	7.8	0.6	3.2	6.3	0.6	3.7	5.1	0.7	4.2	4.2
15	36.1	0.5	1.7	25.3	0.5	2.2	14.4	0.6	2.7	11.8	0.6	3.2	9.7	0.6	3.7	7.9	0.7	4.2	6.5
20	48.1	0.5	1.7	33.8	0.5	2.2	19.2	0.6	2.7	15.8	0.6	3.2	12.9	0.6	3.7	10.7	0.7	4.2	8.8
25	60.1	0.5	1.7	42.2	0.5	2.2	24.0	0.6	2.7	19.7	0.6	3.2	16.2	0.6	3.7	13.4	0.7	4.2	11.2
30	72.1	0.5	1.7	50.6	0.5	2.2	28.8	0.6	2.7	23.6	0.6	3.2	19.4	0.6	3.7	16.1	0.7	4.2	13.5
35	84.1	0.5	1.7	59.1	0.5	2.2	33.6	0.6	2.7	27.6	0.6	3.2	22.6	0.6	3.7	18.7	0.7	4.2	15.7
40	96.2	0.5	1.7	67.5	0.5	2.2	38.4	0.6	2.7	31.5	0.6	3.2	25.8	0.6	3.7	21.4	0.7	4.2	17.9
45	108.2	0.5	1.7	76.0	0.5	2.2	43.2	0.6	2.7	35.4	0.6	3.2	29.0	0.6	3.7	24.1	0.7	4.2	20.2
50	120.2	0.5	1.7	84.4	0.5	2.2	48.0	0.6	2.7	39.4	0.6	3.2	32.3	0.6	3.7	26.8	0.7	4.2	22.4
55	132.2	0.5	1.7	92.8	0.5	2.2	52.8	0.6	2.7	43.3	0.6	3.2	35.5	0.6	3.7	29.4	0.7	4.2	24.7
60	144.2	0.5	1.7	101.3	0.5	2.2	57.6	0.6	2.7	47.2	0.6	3.2	38.7	0.6	3.7	32.1	0.7	4.2	26.9
65	156.3	0.5	1.7	109.7	0.5	2.2	62.4	0.6	2.7	51.2	0.6	3.2	41.9	0.6	3.7	34.8	0.7	4.2	29.1
70	168.3	0.5	1.7	118.2	0.5	2.2	67.2	0.6	2.7	55.1	0.6	3.2	45.2	0.6	3.7	37.5	0.7	4.2	31.4
75	180.3	0.5	1.7	126.6	0.5	2.2	72.0	0.6	2.7	59.0	0.6	3.2	48.4	0.6	3.7	40.1	0.7	4.2	33.6
80	192.3	0.5	1.7	135.0	0.5	2.2	76.8	0.6	2.7	63.0	0.6	3.2	51.6	0.6	3.7	42.8	0.7	4.2	35.9
85	204.3	0.5	1.7	143.5	0.5	2.2	81.6	0.6	2.7	66.9	0.6	3.2	54.9	0.6	3.7	45.5	0.7	4.2	38.1
90	216.4	0.5	1.7	151.9	0.5	2.2	86.4	0.6	2.7	70.8	0.6	3.2	58.1	0.6	3.7	48.1	0.7	4.2	40.3
95	228.4	0.5	1.7	160.3	0.5	2.2	91.2	0.6	2.7	74.8	0.6	3.2	61.3	0.6	3.7	50.8	0.7	4.2	42.5
100	240.4	0.5	1.7	168.8	0.5	2.2	96.0	0.6	2.7	78.7	0.6	3.2	64.5	0.6	3.7	53.5	0.7	4.2	44.8
105	252.4	0.5	1.7	177.2	0.5	2.2	100.8	0.6	2.7	82.6	0.6	3.2	67.8	0.6	3.7	56.2	0.7	4.2	47.1
110	264.4	0.5	1.7	185.7	0.5	2.2	105.6	0.6	2.7	86.6	0.6	3.2	71.0	0.6	3.7	58.8	0.7	4.2	49.3
115	276.5	0.5	1.7	194.1	0.5	2.2	110.4	0.6	2.7	90.5	0.6	3.2	74.2	0.6	3.7	61.5	0.7	4.2	51.5
120	288.5	0.5	1.7	202.5	0.5	2.2	115.2	0.6	2.7	94.4	0.6	3.2	77.4	0.6	3.7	64.2	0.7	4.2	53.8
125	300.5	0.5	1.7	211.0	0.5	2.2	120.0	0.6	2.7	98.4	0.6	3.2	80.7	0.6	3.7	66.9	0.7	4.2	56.0
130	312.5	0.5	1.7	219.4	0.5	2.2	124.8	0.6	2.7	102.3	0.6	3.2	83.9	0.6	3.7	69.5	0.7	4.2	58.3
135	324.5	0.5	1.7	227.9	0.5	2.2	129.6	0.6	2.7	106.2	0.6	3.2	87.1	0.6	3.7	72.2	0.7	4.2	60.5
140	336.6	0.5	1.7	236.3	0.5	2.2	134.4	0.6	2.7	110.2	0.6	3.2	90.3	0.6	3.7	74.9	0.7	4.2	62.7
145	348.6	0.5	1.7	244.7	0.5	2.2	139.2	0.6	2.7	114.1	0.6	3.2	93.6	0.6	3.7	77.6	0.7	4.2	65.0
150	360.6	0.5	1.7	253.2	0.5	2.2	144.0	0.6	2.7	118.0	0.6	3.2	96.8	0.6	3.7	80.2	0.7	4.2	67.2

RETARDANCE 'D' AND 'C'

NOTE: Width and Depth dimensions are in feet. Velocity measurements are in feet per second.  
 Depth 'D' does not include allowance for freeboard or settlement.

Table 6-39.2. Design Chart for Parabolic Vegetated Diversion, Waterway or Stormwater Conveyance (Continued)  
 V1 FOR RETARDANCE T<sub>1</sub>, TOP WIDTH (T), DEPTH (D), AND V2 FOR RETARDANCE T<sub>2</sub>

Grade: 10.00 Percent

Q CFs	V1-2.0		V1-2.5		V1-3.0		V1-3.5		V1-4.0		V1-4.5		V1-5.0		V1-5.5		V1-6.0				
	T	D	T	D	T	D	T	D	T	D	T	D	T	D	T	D	T	D			
5	13.3	0.4	1.3	9.4	0.5	1.7	6.8	0.5	2.2	5.3	2.6	4.1	0.6	3.2	3.4	0.6	3.6	2.6	0.7	4.1	
10	26.6	0.4	1.3	18.7	0.5	1.7	13.8	0.5	2.2	10.9	0.5	2.6	8.5	0.6	3.2	7.1	0.6	3.6	5.9	0.6	4.1
15	39.9	0.4	1.3	28.0	0.5	1.7	20.7	0.5	2.2	16.3	0.5	2.6	12.8	0.6	3.2	10.9	0.6	3.6	9.0	0.6	4.1
20	53.2	0.4	1.3	37.4	0.5	1.7	27.6	0.5	2.2	21.7	0.5	2.7	17.0	0.6	3.2	14.5	0.6	3.6	12.1	0.6	4.1
25	66.5	0.4	1.3	46.7	0.5	1.7	34.5	0.5	2.2	27.1	0.5	2.7	21.3	0.6	3.2	18.1	0.6	3.6	15.1	0.6	4.1
30	79.8	0.4	1.3	56.1	0.5	1.7	41.4	0.5	2.2	32.5	0.5	2.7	25.5	0.6	3.2	21.7	0.6	3.6	18.1	0.6	4.1
35	93.1	0.4	1.3	65.4	0.5	1.7	48.3	0.5	2.2	37.9	0.5	2.7	29.8	0.6	3.2	25.3	0.6	3.6	21.1	0.6	4.1
40	106.4	0.4	1.3	74.7	0.5	1.7	55.2	0.5	2.2	43.3	0.5	2.7	34.0	0.6	3.2	29.0	0.6	3.6	24.1	0.6	4.1
45	119.7	0.4	1.3	84.1	0.5	1.7	62.1	0.5	2.2	48.8	0.5	2.7	38.3	0.6	3.2	32.6	0.6	3.6	27.2	0.6	4.1
50	133.0	0.4	1.3	93.4	0.5	1.7	69.0	0.5	2.2	54.2	0.5	2.7	42.5	0.6	3.2	36.2	0.6	3.6	30.2	0.6	4.1
55	146.3	0.4	1.3	102.8	0.5	1.7	75.9	0.5	2.2	59.6	0.5	2.7	46.8	0.6	3.2	39.8	0.6	3.6	33.2	0.6	4.1
60	159.6	0.4	1.3	112.1	0.5	1.7	82.8	0.5	2.2	65.0	0.5	2.7	51.0	0.6	3.2	43.4	0.6	3.6	36.2	0.6	4.1
65	172.9	0.4	1.3	121.4	0.5	1.7	89.7	0.5	2.2	70.4	0.5	2.7	55.3	0.6	3.2	47.1	0.6	3.6	39.2	0.6	4.1
70	186.2	0.4	1.3	130.8	0.5	1.7	96.6	0.5	2.2	75.8	0.5	2.7	59.5	0.6	3.2	50.7	0.6	3.6	42.2	0.6	4.1
75	199.5	0.4	1.3	140.1	0.5	1.7	103.5	0.5	2.2	81.2	0.5	2.7	63.8	0.6	3.2	54.3	0.6	3.6	45.2	0.6	4.1
80	212.8	0.4	1.3	149.5	0.5	1.7	110.5	0.5	2.2	86.7	0.5	2.7	68.0	0.6	3.2	57.9	0.6	3.6	48.3	0.6	4.1
85	226.1	0.4	1.3	158.8	0.5	1.7	117.4	0.5	2.2	92.1	0.5	2.7	72.3	0.6	3.2	61.5	0.6	3.6	51.3	0.6	4.1
90	239.4	0.4	1.3	168.1	0.5	1.7	124.3	0.5	2.2	97.5	0.5	2.7	76.5	0.6	3.2	65.2	0.6	3.6	54.3	0.6	4.1
95	252.7	0.4	1.3	177.5	0.5	1.7	131.2	0.5	2.2	102.9	0.5	2.7	80.8	0.6	3.2	68.8	0.6	3.6	57.3	0.6	4.1
100	266.0	0.4	1.3	186.8	0.5	1.7	138.1	0.5	2.2	108.3	0.5	2.7	85.0	0.6	3.2	72.4	0.6	3.6	60.3	0.6	4.1
105	279.3	0.4	1.3	196.2	0.5	1.7	145.0	0.5	2.2	113.7	0.5	2.7	89.3	0.6	3.2	76.0	0.6	3.6	63.3	0.6	4.1
110	292.6	0.4	1.3	205.5	0.5	1.7	151.9	0.5	2.2	119.2	0.5	2.7	93.5	0.6	3.2	79.6	0.6	3.6	66.4	0.6	4.1
115	305.9	0.4	1.3	214.9	0.5	1.7	158.8	0.5	2.2	124.6	0.5	2.7	97.8	0.6	3.2	83.3	0.6	3.6	69.4	0.6	4.1
120	319.2	0.4	1.3	224.2	0.5	1.7	165.7	0.5	2.2	130.0	0.5	2.7	102.0	0.6	3.2	86.9	0.6	3.6	72.4	0.6	4.1
125	332.5	0.4	1.3	233.5	0.5	1.7	172.6	0.5	2.2	135.4	0.5	2.7	106.3	0.6	3.2	90.5	0.6	3.6	75.4	0.6	4.1
130	345.8	0.4	1.3	242.9	0.5	1.7	179.5	0.5	2.2	140.8	0.5	2.7	110.5	0.6	3.2	94.1	0.6	3.6	78.4	0.6	4.1
135	359.1	0.4	1.3	252.2	0.5	1.7	186.4	0.5	2.2	146.2	0.5	2.7	114.8	0.6	3.2	97.7	0.6	3.6	81.4	0.6	4.1
140	372.4	0.4	1.3	261.6	0.5	1.7	193.3	0.5	2.2	151.7	0.5	2.7	119.0	0.6	3.2	101.3	0.6	3.6	84.4	0.6	4.1
145	385.7	0.4	1.3	270.9	0.5	1.7	200.2	0.5	2.2	157.1	0.5	2.7	123.3	0.6	3.2	105.0	0.6	3.6	87.5	0.6	4.1
150	399.0	0.4	1.3	280.2	0.5	1.7	207.1	0.5	2.2	162.5	0.5	2.7	127.5	0.6	3.2	108.6	0.6	3.6	90.5	0.6	4.1

RETARDANCE T<sub>1</sub> AND T<sub>2</sub>

NOTE: Width and Depth dimensions are in feet; Velocity measurements are in feet per second; Depth T<sub>1</sub> does not include allowance for freeboard or settlement.

Table 6-39.3. Diversion Design Table D Retardance (V and Trapezoidal Section)  
 (Based on Handbook of Channel Design, SCS-TP-61)

3:1 Side Slopes  
 0.5' Retardance

%	Triangular					6' bottom width					8' bottom width					10' bottom width					12' bottom width								
	2	3	4	5		2	3	4	5		2	3	4	5		2	3	4	5		2	3	4	5					
Grade	d	A	d	A	d	A	d	A	d	A	d	A	d	A	d	A	d	A	d	A	d	A	d	A	d	A	d	A	
Q-cfs	1.9	11	1.8	10	1.7	9	1.6	8	1.5	7	1.4	6	1.3	5	1.2	4	1.1	3	1.0	2	0.9	1	0.8	1	0.7	1	0.6	1	
20	2.2	15	2.1	13	1.9	11	1.8	10	1.6	8	1.5	7	1.4	6	1.3	5	1.2	4	1.1	3	1.0	2	0.9	1	0.8	1	0.7	1	
30	2.5	19	2.3	16	2.2	15	2.0	12	1.8	11	1.6	9	1.5	7	1.4	6	1.3	5	1.2	4	1.1	3	1.0	2	0.9	1	0.8	1	
40	2.6	20	2.5	19	2.3	16	2.2	15	2.0	12	1.8	11	1.6	9	1.5	7	1.4	6	1.3	5	1.2	4	1.1	3	1.0	2	0.9	1	
50	3.0	27	2.8	24	2.7	22	2.5	19	2.3	16	2.1	14	1.9	12	1.7	10	1.6	9	1.5	8	1.4	7	1.3	6	1.2	5	1.1	4	
60	3.1					29	2.9	25	2.7	22	2.5	20	2.3	18	2.1	15	1.9	14	1.7	12	1.5	10	1.3	8	1.1	6	1.0	4	
100	3.0					27	3.0	45	2.8	40	2.5	34	2.3	30	2.1	26	2.0	26	2.0	26	2.0	26	2.0	26	2.0	26	2.0	26	2.0
120	3.0					43	2.6	36	2.4	32	2.3	30	2.2	28	2.1	26	2.0	26	2.0	26	2.0	26	2.0	26	2.0	26	2.0	26	2.0
140	3.0					45	2.8	40	2.5	34	2.3	30	2.1	26	2.0	26	2.0	26	2.0	26	2.0	26	2.0	26	2.0	26	2.0	26	2.0
160	3.0					45	2.8	40	2.5	34	2.3	30	2.1	26	2.0	26	2.0	26	2.0	26	2.0	26	2.0	26	2.0	26	2.0	26	2.0
180	3.0					45	2.8	40	2.5	34	2.3	30	2.1	26	2.0	26	2.0	26	2.0	26	2.0	26	2.0	26	2.0	26	2.0	26	2.0
200	3.0					45	2.8	40	2.5	34	2.3	30	2.1	26	2.0	26	2.0	26	2.0	26	2.0	26	2.0	26	2.0	26	2.0	26	2.0
220	3.0					45	2.8	40	2.5	34	2.3	30	2.1	26	2.0	26	2.0	26	2.0	26	2.0	26	2.0	26	2.0	26	2.0	26	2.0

NOTE: For diversions built on slopes under 2%, the available cross-sectional area above normal ground will allow a reduction in design depth as follows:

For land slopes of 1% or less, reduce depth of flow (taken from Design Table) 20%.

For land slopes of 1% to 2%, reduce depth of flow (taken from Design Table) 10%.

For land slopes greater than 2%, use depth of flow taken from Design Table.

For Example: A diversion 6 feet wide with a 2.5 feet depth of flow is required to remove 120 c.f.s. on a 0.4% grade. If this is built on a 1% slope, the depth may be reduced 20%, thus obtaining a flow depth of 2.0 feet. The required cross-sectional area of the channel plus that above normal ground line will be 34 square feet corresponding to the 2.5 feet depth. The overall height of diversion will be 2.6 feet plus 0.5 foot freeboard or 3.1 feet, instead of the original 3.0 feet.

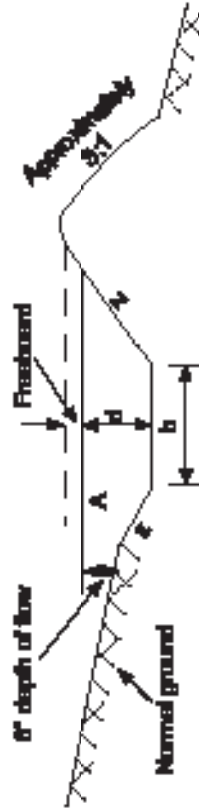

d = depth of flow, feet

b = bottom width of channel, feet

A = channel capacity, eq. 8, including area below 0.5' freeboard and including any area less than 0.5' depth of flow

z = side slopes of channel (fractured horizontal)

NOTE: It is of designed depth of flow and freeboard required by State

Standards and Specifications to obtain overall height of diversion above

bottom of channel. For first check on cross-sectional area, subtract required

freeboard from overall height of diversion and provide for cross-sectional

area shown in table.



Table 6-39.3. Diversion Design Table D Retardance (V and Trapezoidal Section) (Continued)  
 (Based on Handbook of Channel Design, SCS-TP-61)

A-1 Side Slopes  
 10° Retardance

%	Triangular					6' bottom width					8' bottom width					10' bottom width					12' bottom width				
	2	3	4	5	6	2	3	4	5	6	2	3	4	5	6	2	3	4	5	6	2	3	4	5	6
Example	d'A	d'A	d'A	d'A	d'A	d'A	d'A	d'A	d'A	d'A	d'A	d'A	d'A	d'A	d'A	d'A	d'A	d'A	d'A	d'A	d'A	d'A	d'A	d'A	d'A
Q-cfs	1.8-13	1.7-12	1.6-11	1.5-10	1.4-13	1.1-11	1.0-10	0.9-9	1.1-14	1.0-13	0.9-11	0.8-10	1.1-14	1.0-13	0.9-12	0.8-11	1.0-15	0.9-14	0.8-13	1.0-17	0.8-12	1.0-16	0.9-15	0.8-14	1.0-18
20	2.1-16	2.0-15	1.8-13	1.7-12	1.5-11	1.4-10	1.3-9	1.1-8	1.4-13	1.3-12	1.2-11	1.1-10	1.4-13	1.3-12	1.2-11	1.1-10	1.3-14	1.2-13	1.1-12	1.4-17	1.3-16	1.2-15	1.1-14	1.3-17	1.2-16
30	2.4-23	2.2-19	2.1-18	1.9-14	1.8-24	1.5-20	1.4-18	1.2-15	1.7-25	1.6-24	1.5-21	1.4-19	1.7-25	1.6-24	1.5-23	1.4-22	1.7-28	1.6-27	1.5-26	1.9-31	1.8-29	1.7-28	1.6-27	1.8-30	1.7-29
40	2.5-25	2.4-23	2.2-19	2.1-18	1.9-26	1.6-20	1.5-18	1.3-15	1.7-22	1.6-21	1.5-20	1.4-19	1.7-22	1.6-21	1.5-20	1.4-19	1.8-24	1.7-23	1.6-22	2.0-26	1.9-25	1.8-24	1.7-23	1.9-25	1.8-24
60	2.8-31	2.6-27	2.5-25	2.3-21	2.2-33	1.9-26	1.7-22	1.5-18	2.0-32	1.9-30	1.7-25	1.6-23	2.0-32	1.9-30	1.8-27	1.6-25	2.1-34	2.0-32	1.9-31	2.3-40	2.2-38	2.1-36	2.0-35	2.2-39	2.1-37
80	3.1-36	2.9-34	2.7-29	2.5-25	2.4-37	2.2-33	2.1-30	1.9-26	2.3-40	2.2-38	2.1-36	2.0-34	2.3-40	2.2-38	2.1-37	2.0-36	2.4-42	2.3-40	2.2-39	2.5-45	2.4-43	2.3-41	2.2-40	2.4-44	2.3-42
100	3.1-36	2.9-34	2.7-29	2.5-25	2.4-37	2.2-33	2.1-30	1.9-26	2.3-40	2.2-38	2.1-36	2.0-34	2.3-40	2.2-38	2.1-37	2.0-36	2.4-42	2.3-40	2.2-39	2.5-45	2.4-43	2.3-41	2.2-40	2.4-44	2.3-42
120																									
140																									
160																									
180																									
200																									
220																									

E-1 Side Slopes  
 10° Retardance

%	Triangular					6' bottom width					8' bottom width					10' bottom width					12' bottom width				
	2	3	4	5	6	2	3	4	5	6	2	3	4	5	6	2	3	4	5	6	2	3	4	5	6
Example	d'A	d'A	d'A	d'A	d'A	d'A	d'A	d'A	d'A	d'A	d'A	d'A	d'A	d'A	d'A	d'A	d'A	d'A	d'A	d'A	d'A	d'A	d'A	d'A	d'A
Q-cfs	1.6-15	1.5-14	1.4-13	1.3-11	1.2-16	1.1-14	1.0-12	0.9-10	1.1-17	1.0-16	0.9-14	0.8-13	1.1-17	1.0-16	0.9-15	0.8-14	1.1-19	1.0-18	0.9-17	1.2-21	1.1-20	1.0-19	0.9-18	1.1-21	1.0-20
10	1.9-22	1.8-19	1.6-15	1.5-14	1.3-17	1.2-16	1.1-14	1.0-12	1.4-21	1.3-20	1.2-18	1.1-16	1.4-21	1.3-20	1.2-19	1.1-18	1.5-24	1.4-23	1.3-22	1.7-26	1.6-25	1.5-24	1.4-23	1.6-27	1.5-26
20	2.1-27	2.0-24	1.8-19	1.7-17	1.5-23	1.4-20	1.3-18	1.2-16	1.6-28	1.5-26	1.4-23	1.3-21	1.6-28	1.5-26	1.4-25	1.3-22	1.8-33	1.7-31	1.6-30	2.0-34	1.9-33	1.8-32	1.7-31	1.9-34	1.8-33
30	2.3-32	2.2-29	2.0-24	1.8-19	1.7-28	1.6-25	1.5-23	1.4-20	1.7-31	1.6-29	1.5-26	1.4-23	1.7-31	1.6-29	1.5-28	1.4-25	2.0-37	1.9-35	1.8-34	2.2-40	2.1-39	2.0-38	1.9-37	2.1-40	2.0-39
40	2.5-36	2.3-32	2.2-29	2.0-24	1.8-30	1.7-28	1.6-26	1.5-23	1.9-35	1.8-34	1.7-31	1.6-29	1.9-35	1.8-34	1.7-33	1.6-31	2.1-42	2.0-40	1.9-39	2.3-46	2.2-44	2.1-43	2.0-42	2.2-45	2.1-44
60	2.7-44	2.5-38	2.4-35	2.2-29	2.2-42	2.1-39	1.9-35	1.8-30	2.1-43	2.0-41	1.9-38	1.8-34	2.1-43	2.0-41	1.9-40	1.8-37	2.3-49	2.2-47	2.1-46	2.5-53	2.4-51	2.3-50	2.2-49	2.4-52	2.3-51
80	2.9-51	2.7-44	2.6-41	2.4-35	2.4-49	2.3-46	2.1-39	1.9-35	2.5-58	2.4-56	2.3-53	2.2-51	2.5-58	2.4-56	2.3-55	2.2-53	2.6-63	2.5-61	2.4-60	2.8-70	2.7-68	2.6-67	2.5-66	2.7-69	2.6-68
100	3.0-54	2.8-47	2.7-44	2.5-38	2.6-56	2.5-53	2.4-51	2.3-48	2.7-63	2.6-61	2.5-58	2.4-56	2.7-63	2.6-61	2.5-60	2.4-58	2.8-73	2.7-71	2.6-70	3.0-80	2.9-78	2.8-77	2.7-76	2.9-79	2.8-78
140																									
160																									
180																									
200																									
220																									
240																									
260																									



Table 6-39.4. Diversion Design Table C Retardance (V and Trapezoidal Section) (Continued)  
 (Based on Handbook of Channel Design, SCS-TP-61)

E-1 Side Slopes

% Retardance

%	Triangular					6' bottom width					8' bottom width					10' bottom width					12' bottom width				
	2	3	4	5		2	3	4	5		2	3	4	5		2	3	4	5		2	3	4	5	
10	1.8	1.9	2.1	2.2	2.3	1.8	1.9	2.1	2.2	2.3	1.8	1.9	2.1	2.2	2.3	1.8	1.9	2.1	2.2	2.3	1.8	1.9	2.1	2.2	2.3
20	2.1	2.2	2.4	2.5	2.6	2.1	2.2	2.4	2.5	2.6	2.1	2.2	2.4	2.5	2.6	2.1	2.2	2.4	2.5	2.6	2.1	2.2	2.4	2.5	2.6
30	2.4	2.5	2.7	2.8	2.9	2.4	2.5	2.7	2.8	2.9	2.4	2.5	2.7	2.8	2.9	2.4	2.5	2.7	2.8	2.9	2.4	2.5	2.7	2.8	2.9
40	2.5	2.6	2.8	2.9	3.0	2.5	2.6	2.8	2.9	3.0	2.5	2.6	2.8	2.9	3.0	2.5	2.6	2.8	2.9	3.0	2.5	2.6	2.8	2.9	3.0
50	2.6	2.7	2.9	3.0	3.1	2.6	2.7	2.9	3.0	3.1	2.6	2.7	2.9	3.0	3.1	2.6	2.7	2.9	3.0	3.1	2.6	2.7	2.9	3.0	3.1
60	2.7	2.8	3.0	3.1	3.2	2.7	2.8	3.0	3.1	3.2	2.7	2.8	3.0	3.1	3.2	2.7	2.8	3.0	3.1	3.2	2.7	2.8	3.0	3.1	3.2
80	2.9	3.0	3.2	3.3	3.4	2.9	3.0	3.2	3.3	3.4	2.9	3.0	3.2	3.3	3.4	2.9	3.0	3.2	3.3	3.4	2.9	3.0	3.2	3.3	3.4
100	3.0	3.1	3.3	3.4	3.5	3.0	3.1	3.3	3.4	3.5	3.0	3.1	3.3	3.4	3.5	3.0	3.1	3.3	3.4	3.5	3.0	3.1	3.3	3.4	3.5
120	3.1	3.2	3.4	3.5	3.6	3.1	3.2	3.4	3.5	3.6	3.1	3.2	3.4	3.5	3.6	3.1	3.2	3.4	3.5	3.6	3.1	3.2	3.4	3.5	3.6
140	3.2	3.3	3.5	3.6	3.7	3.2	3.3	3.5	3.6	3.7	3.2	3.3	3.5	3.6	3.7	3.2	3.3	3.5	3.6	3.7	3.2	3.3	3.5	3.6	3.7
160	3.3	3.4	3.6	3.7	3.8	3.3	3.4	3.6	3.7	3.8	3.3	3.4	3.6	3.7	3.8	3.3	3.4	3.6	3.7	3.8	3.3	3.4	3.6	3.7	3.8
180	3.4	3.5	3.7	3.8	3.9	3.4	3.5	3.7	3.8	3.9	3.4	3.5	3.7	3.8	3.9	3.4	3.5	3.7	3.8	3.9	3.4	3.5	3.7	3.8	3.9
200	3.5	3.6	3.8	3.9	4.0	3.5	3.6	3.8	3.9	4.0	3.5	3.6	3.8	3.9	4.0	3.5	3.6	3.8	3.9	4.0	3.5	3.6	3.8	3.9	4.0
220	3.6	3.7	3.9	4.0	4.1	3.6	3.7	3.9	4.0	4.1	3.6	3.7	3.9	4.0	4.1	3.6	3.7	3.9	4.0	4.1	3.6	3.7	3.9	4.0	4.1

# APPENDIX A

## WinTR-55 and TR-20

### National Engineering Handbook, Part 630, Hydrology (NEH630)

The Soil Conservation Service (SCS, now NRCS) first developed the National Engineering Handbook, Section 4, Hydrology (NEH-4) as a means of documenting the procedures which were being developed for evaluating the hydrology of watersheds in watershed planning projects. Prior to this time (the early 1950s), there was no comprehensive guidance available for such projects. Later, the SCS became the Natural Resources Conservation Service (NRCS) and the NEH-4 was renamed to be the National Engineering Handbook, Part 630, Hydrology (NEH630).

NEH630 documents the technical aspects of the hydrologic methodologies used to develop runoff hydrographs, to a limited extent, to route such hydrographs. The NRCS NEH Part 630 can be downloaded by chapter from the NRCS eDirectives web-site at: <http://directives.sc.egov.usda.gov/viewDirective.aspx?hid=21422>

### **TECHNICAL RELEASE NO. 20: PROJECT FORMULATION – HYDROLOGY (TR-20)**

Technical Release No. 20, Project Formulation – Hydrology (TR-20) was developed in the 1960s to automate the hydrologic evaluation of large multi-sub-area watersheds using procedures found in the National Engineering Handbook, Section 4, Hydrology (NEH-4) TR-20 was originally issued as a mainframe computer program designed to run on a Harris mainframe system. In the 1980s, TR-20 was updated to run in a disk-operating system (DOS) environment on a personal computer (PC). Eventually, TR-20 was updated to run in a Windows environment on the PC. In this iteration, the computation engine, TR-20, sits behind the graphical user interface, WinTR-20 which allows users to enter, edit, and display input data; run the TR-20 model; and display output.

TR-20 develops full hydrographs at user specified locations throughout a watershed and allows the user to route the hydrographs through stream channels and structures based on user input rating curves. The TR-20 model has been updated over time to take advantage of advances and updates in hydrologic science. One example of this is the procedure used to route hydrographs through stream channels. The original TR-20 utilized the convex routing procedure. Later that was replaced by the Att-Kin method. The current TR-20/WinTR-20 uses the Muskingum-Cunge method.

The current WinTR-20 computer program and documentation can be downloaded from the following web-site: [http://www.nrcs.usda.gov/wps/portal/nrcs!ut/p/c4/04\\_SB8K8xLLM9MS-SzPy8xBz9CP0os\\_hAE3NjV08fEwOLs-CAXA09PMx\\_HIBcLY3cDA\\_2CbEdFAJZtSik!/?ss=16&navtype=TOPNAVIGATION&cid=stelprdb1042198&navid=8600000000000000&pnavid=null&position=Not%2520Yet%2520Determined.Html&ttype=detail&pname=USDA%2520NRCS%2520-%2520Natural%2520Resources%2520Conservation%2520Service%2520-%2520National%2520Design.%2520Construction.%2520and%2520Soil%2520Mechanics%2520Center](http://www.nrcs.usda.gov/wps/portal/nrcs!ut/p/c4/04_SB8K8xLLM9MS-SzPy8xBz9CP0os_hAE3NjV08fEwOLs-CAXA09PMx_HIBcLY3cDA_2CbEdFAJZtSik!/?ss=16&navtype=TOPNAVIGATION&cid=stelprdb1042198&navid=8600000000000000&pnavid=null&position=Not%2520Yet%2520Determined.Html&ttype=detail&pname=USDA%2520NRCS%2520-%2520Natural%2520Resources%2520Conservation%2520Service%2520-%2520National%2520Design.%2520Construction.%2520and%2520Soil%2520Mechanics%2520Center)

### **TECHNICAL RELEASE NO. 55 IN, URBAN HYDROLOGY FOR SMALL WATERSHEDS (TR-55)**

Technical Release No. 55, Urban Hydrology for Small Watersheds (TR-55) was originally developed in 1975 in response to an increased focus on the analysis of small urbanizing watersheds. The procedures found in the SCS-TP 149, *A Method for Estimating Volume and Rate of Runoff in Small Watersheds* (which later morphed into the Engineering Field Manual Chapter 2, Estimating Runoff Volume and Peak Discharge), and the methodologies found in the NEH-4 were focused on agricultural watersheds.

The curve number tables found in NEH-4 and TP-149 did not cover urban or urbanizing areas. TR-55 expanded the curve number tables to include urban and urbanizing areas.

TR-55 was developed as a manual method

by utilizing multiple runs of TR-20 to develop generalized tables and graphs from the output to cover a range of watershed conditions, primarily restricted by time of concentration. Contrary to popular belief, TR-55 was not limited to watersheds of a specific size, but instead was limited to watersheds with times of concentration ranging from 0.1 to 5 hours

Additionally, the 1975 version of TR-55 covered only areas for which the Type II rainfall distribution was appropriate. The 1986 version of the TR-55 added generalized curves and tables for Types I, IA, and III rainfall distributions and expanded the range of applicability for time of concentration up to 10 hours. A DOS based TR55 computer program was also developed in the 1980s. This computer program was a sort of spread-sheet based program that mirrored the published document.

TR-55 gives the user an estimate of runoff volume and a peak discharge estimate, or in the case of the tabular method, a partial hydrograph bracketing the peak discharge.

NRCS no longer supports (updates) TR-55 and no longer encourages its use. We do understand that TR-55 has gained widespread acceptance and use, so, while it is not available as an official NRCS directive, we do still make it available for download. Information on downloading the 1986 TR-55 and accompanying computer program can be found at the following web-site <http://www.nrcs.usda.gov/wps/portal/nrcs/detailfull/national/technical/alphabetical/water/hydrology/?&cid=stelprdb1042922> which provides links for this and other computer programs no longer supported by NRCS.

The updated WinTR-55 computer program, Small Watershed Hydrology, was developed as a windows update/replacement to the DOS based TR55 computer program. While TR55 was based on generalized tables and graphs to provide an estimate of peak discharge and allowed the user to develop a partial hydrograph, the WinTR-55 computer program uses the latest TR-20 computational engine (behind the WinTR-55 graphical user interface) to compute full hydrographs.

The limitations, now including a drainage area

size limitation, placed on WinTR-55 were done so in order to limit its use to watershed similar to those that could be modeled with the DOS based TR55.

A more complete discussion of the differences between TR55 and WinTR-55 can be found in a technical paper The New USDA-NRCS WinTR-55 Small Watershed Hydrology Model by Claudia Scheer and Karl Visser, and presented at the 2002 Federal Interagency Hydrologic Modeling Conference, Las Vegas, NV can be found in the conference proceedings (pp. 404-410) through the following web-site: [http://acwi.gov/hydrology/mtsconfwkshops/conf\\_proceedings/index.html/](http://acwi.gov/hydrology/mtsconfwkshops/conf_proceedings/index.html/) (Please note that the web-links referenced in the paper (including the e-mail addresses) are no longer valid).

The WinTR-55 computer program can be downloaded at:

[http://www.nrcs.usda.gov/wps/portal/nrcs!/ut/p/c4/04\\_SB8K8xLLM9MSSzPy8xBz9CP0os\\_hAE3NjV08fEwOLsCAXA09PMx\\_HIBcLY3cDA\\_2CbEdFAJZtSik!/?ss=16&navtype=TOPNAVIGATION&cid=stelprdb1042198&navid=8600000000000000&pnavid=null&position=Not%2520Yet%2520Determined.Html&ttype=detail&pname=USDA%2520NRCS%2520-%2520Natural%2520Resources%2520Conservation%2520Service%2520-%2520National%2520Design,%2520Construction,%2520and%2520Soil%2520Mechanics%2520Center](http://www.nrcs.usda.gov/wps/portal/nrcs!/ut/p/c4/04_SB8K8xLLM9MSSzPy8xBz9CP0os_hAE3NjV08fEwOLsCAXA09PMx_HIBcLY3cDA_2CbEdFAJZtSik!/?ss=16&navtype=TOPNAVIGATION&cid=stelprdb1042198&navid=8600000000000000&pnavid=null&position=Not%2520Yet%2520Determined.Html&ttype=detail&pname=USDA%2520NRCS%2520-%2520Natural%2520Resources%2520Conservation%2520Service%2520-%2520National%2520Design,%2520Construction,%2520and%2520Soil%2520Mechanics%2520Center)

Additional information on all NRCS hydrologic tools and methodologies can be found at:

<http://www.nrcs.usda.gov/wps/portal/nrcs/main/national/technical/alphabetical/water/hydrology>. The “Tools and Models” and “Technical Information” links specifically link to a great deal of additional information.

## WIN TR-20

### BACKGROUND

Using a 24- hr design storm distribution is standard practice in Win TR-20. In order to best reflect the updated NOAA Atlas 14 precipitation data, a site specific distribution is developed based on the text file download from the NOAA Atlas 14 website. The 24- hr design storm distribution is developed based on maximizing

the rainfall during and duration from 5-minutes to 24-hours. The duration from 5 minutes to 24 hours are centered on 12 hours and extended symmetrically for the periods before and after 12 hours. Investigations were conducted which showed that regional storm distribution similar to the prior standard NRCS storm distributions (Type 1, Type IA, Type II and Type III) are not feasible in states covered by NOAA Atlas 14.

## TO DATA SMOOTHING TECHNIQUE

Several mathematical techniques were investigated to determine a computationally efficient, accurate, practical, stable and robust procedure. Since the generated hydrograph is primarily dependent on the relationship of precipitation intensity with duration, this relationship is what is smoothed. This relationship of intensity (inches/hour) and duration is based on a factor defined as incremental intensity. Incremental intensity is defined as the difference in precipitation divided by the difference in duration. The incremental intensity for the 5-minute duration is equal to the 5-minute precipitation divided by  $\frac{1}{2}$  and has the units of inches per hour (or mm/hour in metric units). The incremental intensity for the 10 minute duration is the 10-minute precipitation minus the 5 and 10 minutes in units of hours. Each incremental intensity is calculated based on the difference in precipitation divided by the difference in duration. Incremental intensity is calculated and smoothed for each return period independently.

The final smoothing procedure keeps the 5-minute, 60-minute and 24-hour precipitation unchanged from the original NOAA Atlas 14 values. 10,15,30 and 120-minute and 3,6,12-hour values are open to adjustment. The incremental intensity for the 5-minute duration is unchanged. A straight line on the log-log plot extends from 5-minute to 60-minute duration. A second straight line segment on the log-log plot extends from the 60-minute value to 24-hour value.

**CONCLUSION and SUMMARY** – the user has the option to develop storm distributions based on the original NOAA Atlas 14 data or smoothed data. Comparing hydrographs generated by original and smoothed data indicated that with the smoothed data, peak discharges may vary by

as much as plus or minus 10%.

## OVERVIEW

The Win TR-20 System Controller/Editor allows running on any of the system components (TR-20 model, input convertor, import NOAA Atlas data, and HEC-RAS reformatter) as well as editing a WinTR-20 input file. The Controller/Editor is organized following the input sections described in the user documentation. For editing, each WinTR-20 input section has its own entry window which is accessible by clicking the input section name on the main window. In addition to the input section entry windows, there are entry windows for locally added land used identifiers (w/ runoff curve numbers by hydrologic soil group) and locally added soils (w/ applicable hydrologic soil groups). Entry windows for these two local additions are accessible from the File pull down on main window.

## HELP FACILITIES

Help windows of a general nature on the program system are available via the new user button (available at program start up) or from the Help pull down on the main window. All of the Help windows are available from the pull down while only selected ones are available via the "New User ? Click Here" button.

The data entry window that allow for entry and/or editing of input data contain additional Help in the form of information about the current window and the information about each variable to be entered. This Help is available by clicking the window or variable name on the entry window. A Help box opens in the lower left corner of the entry window and displays the window or variable name, its description and range of values (if appropriate). Only window and variable names shown in yellow have such help available. A second click on the window or variable names closes the Help box.

## GETTING STARTED

### TO EDIT WIN TR-20 INPUT FILE

Select one of the first three File pull down choices (New WinTR-20 File, Open Existing WinTR-20 File, and Re-Open Last Session) on

the main window. No matter which of the three are selected, the WinTR-20 Identifier entry window appears. Make sure the proper input unit system (English or metric) is selected. Once the information on the window is completed, accept the data by clicking the "Accept Changes (Close)" button. The WinTR-20 Identifier Window will close leaving the main window. Continue by clicking (selecting) another input section entry window from the list on the main window. To save data entered, use the Save or SaveAs selections on the File pull down. Remember to save early and save often.

**TO CONVERT OLD TR-20 INPUT FILE** – Select Convert Old Data from the File pull down on the main window. Then select the file name to be converted to start the converter. When the converter run is complete, either the Error File (indicating a problem with converting the data) will displayed or the WinTR-20 Identifier entry window will open for editing the converted data.

**TO REFORMAT HEC-RAS** from the File pull down on the main window. Then select the HEC-RAS output file name to be reformatted. If a WinTR-20 input file is currently loaded, the choice to either add to the current data or start a new file can also be made. After reformatting is complete, either the Error File will be displayed or the WinTR-20 Identifier entry window will open for editing the file containing the reformatted data.

**To IMPORT NOAA ATLAS 14 DATA** – Select Import NOAA Data from the File pull down menu on the main window. Then enter NOAA Atlas text file. Do not try to import NOAA Data into WinTR-20 input file if currently loaded, the data will be deleted and substituted with NOAA Atlas data. It is recommended to open a new file to include only NOAA Atlas data.

**TO RUN WINTR-20 INPUT FILE USING THE EDIT, CONVERT, and/or REFORMAT** techniques described above. Select WinTR-20 from the Run pull down on the main window to run WinTR-20 model. When the run is complete either the Error file or WinTR-20 output file will be displayed. (Note: The Run pull down is ONLY available if the current data has a file name (not ">Untitled<") and the data has not been modified since it was loaded or saved. If Run

is not displayed, then save the current data to make the Run pull down visible.)

## **EFH2 PEAK DISCHARGE DETERMINATION**

A program for determining peak discharge as prescribed by Engineering Field Handbook Chapter 2. Required information includes watershed characteristics (drainage area, curve number, hydraulic length, watershed slope) and rainfall amount and distribution.

This program has restricted applications. May be applied when:

- Watershed is accurately represented by a single runoff curve number between 40 and 98.
- Watershed area is between 1 and 2,000 acres.
- Watershed hydraulic length is between 200 and 26,000 feet.
- Average watershed slope is between 0.5 and 64%.
- No valley or reservoir routing is required.
- Urban land use within the watershed does not exceed 10%.

For complete information please visit:  
<http://www.nrcs.usda.gov/wps/portal/nrcs/detail-full/national/water/manage/?cid=stelprdb1042921>

# APPENDIX A-2

## Joining the Equivalent BMP List: Application and Removal Process

### BACKGROUND AND PURPOSE

Pursuant to the Clean Water Act, EPA established requirements for storm water discharges under the National Pollutant Discharge Elimination System (NPDES) permitting program. Georgia's Environmental Protection Division (EPD) administers three NPDES General Permits that authorize the discharge of storm water from sites where construction activities occur. Each of these permits requires BMPs to be implemented in accordance with the design specifications contained in the Manual for Erosion and Sediment Control (Manual) published by the Georgia Soil and Water Conservation Commission (GSWCC).

The allowance of the efficient addition of proven BMPs that are at least as stringent as the Manual for Erosion and Sediment Control recognizes the dynamic growth and technological advancements in the area of BMP development. Each of the NPDES General Permits authorizing the discharge of storm water also allows for Alternative BMPs – BMPs not listed in the Manual – to be used if they meet the following requirement:

The use of alternative BMPs whose performance has been documented to be equivalent or superior to conventional BMPs as certified by a Design Professional may be allowed (unless disapproved by EPD or the State Soil and Water Conservation Commission).

GSWCC and EPD have previously developed a guidance document for the use of Alternative BMPs. Specifically, the Design Professional preparing the Erosion, Sedimentation and Pollution Control Plan (ES&PC Plan) for a permittee must sign and certify the following documentation:

1. One page summary detailing why the alternative BMP is equivalent or superior to the conventional BMPs found in the Manual.

2. Documented side by side testing (alternative BMP vs. conventional BMP) using the appropriate design requirements and specifications contained in the Manual.
3. Proof that the alternative BMP was previously installed and worked under conditions comparable to the environmental conditions of the proposed site. This can be documented with photographs.
4. All specifications including the design requirements and the procedures for proper installation and maintenance.

In the year 2015, BMPs not in the Manual may be approved as part of the Alternative BMP process described above. Allowing a new mechanism for Alternative BMPs repeatedly used and approved under GSWCC Guidance to be placed on an Equivalent BMP List would increase efficiency for all the agencies involved and the development community. This would be similar to the 5th edition of the Manual's recognition of materials approved by the Georgia Department of Transportation (GDOT), which appear on GDOT's Qualified Products List (QPL). As of January 1, 2016, any product that seeks to be on the GDOT QPL List must first go through the Equivalent BMP process. GSWCC's approval of a BMP however does not ensure GDOT's adoption of that item into their QPL, design policies or procedures.

Therefore, the purpose of this document is to provide a process by which BMPs having demonstrated success in the field at least three times under the Alternative BMP process and having been bench tested may be placed on an Equivalent BMP List. The procedure also includes a mechanism for removing BMPs from the Equivalent BMP list. In addition, the GSWCC has the discretion to remove a BMP from the Equivalent BMP List at any time.

### PROCEDURE FOR APPLYING FOR THE EQUIVALENT BMP LIST

For a BMP to be considered for inclusion on the Equivalent BMP List, a Design Professional must have successfully completed the current process for Alternative BMPs as outlined by GSWCC Guidance on at least three completed projects where EPD's Notice of Termination Form has been filed. Geographic dispersion of the



project sites is encouraged. The following steps are required:

1. Provide pre-notice to EPD and GSWCC of the intent to apply for an Alternative BMP to be included on the Equivalent BMP List as follows:

- A. Specify on the required checklist that accompanies the Notice of Intent Form that the project includes an Alternative BMP that will be included on an Application for the Equivalent BMP List.
- B. Inform GSWCC of the intent to apply by sending a digital copy of the approved ES&PC plan and a copy of the above to GSWCC when each NOI is filed with EPD.

2. Once the project involving the Alternative BMP has been completed and a Notice of Termination Form for the project has been filed, submit to GSWCC the following:

- A. An Application to be on the Equivalent BMP List and a sample of the BMP.
- B. Three sets -- one for each time the Alternative BMP was used in three separate projects -- of the required documentation to use the Alternative BMP, based on the current approval process as outlined by GSWCC Guidance. Evidence of repeatable bench and field testing must be included as part of this documentation.
- C. Three sets -- one for each time the Alternative BMP was used in three separate projects -- of the Notice of Termination Form for each project involving the Alternative BMP.
- D. A Certification Form signed by two individuals -- a Level II certified Design Professional and a Level 1A or Level 1B Certified Personnel -- who evaluated the BMPs performance in the field stating that the Alternative BMP performed as expected throughout the life of each of the three projects.
- E. Three sets of installation photos -- one for each time the Alternative BMP was used -- of the Alternative BMP utilized in the three projects.

- F. Three sets of after-storm event photos -- one for each time the Alternative BMP was used -- of the Alternative BMP utilized in the three projects.
- G. Any post-storm event inspection records as well as inspection and enforcement records made by any federal, state, or local regulatory agency related to this specific BMP on this project.

The above materials should be submitted to GSWCC both electronically and with hard copies to P.O. Box 8024, Athens, Georgia 30603. GSWCC will provide copies of the materials submitted to EPD and GDOT upon receipt. GSWCC will receive and review the information submitted above. GSWCC has the discretion to approve the application, deny the application, request a resubmittal, or request additional information. Applicants will be informed of GSWCC's determination in writing. Applicants receiving approval for inclusion on the Equivalent BMP List will be notified within 90 days. Applicants with BMPs denied from inclusion on the Equivalent BMP List may seek review of the GSWCC's determination from the GSWCC State Board.

#### **PROCEDURE FOR REMOVING A BMP FROM THE EQUIVALENT BMP LIST**

Any individual, local government, or agency may submit to GSWCC a request that the BMP be removed from the Equivalent BMP List. The request should include a certified statement that the Alternative BMP failed to perform as expected and thus should be removed from the Equivalent BMP List, along with supporting documentation (picture, inspection forms, etc.). The request should be submitted to GSWCC both electronically and with hard copies to P.O. Box 8024, Athens, Georgia 30603.

GSWCC will provide copies of the request for removal to EPD and GDOT upon receipt. GSWCC will also provide a copy of the request to the individual who initially applied for the Alternative BMP to be included on the Equivalent BMP List. GSWCC has the discretion to approve the request, deny the request, request a resubmittal, or request additional information.

An applicant with a BMP removed from the Equivalent BMP List may seek review of the GSWCC's determination from the GSWCC State Board.

An Alternative BMP removed from the Equivalent BMP List may be returned to the list if an applicant successfully completes the Procedure for Applying for the Equivalent BMP List again.

## TRANSITION PERIOD

The Manual for Erosion and Sediment Control in Georgia has been revised and revisions will become effective January 1, 2016. The Equivalent BMP List will first be made available January 1, 2016. BMPs included in the 5th Edition of the Manual and GDOT's QPL list will be recognized by GSWCC and included on the Equivalent BMP List. Applications for BMPs to be included on the Equivalent BMP list will be based on NOI'S submitted on or after January 1, 2016. GSWCC's approval of a BMP however does not ensure GDOT's adoption of that item into their QPL, design policies or procedures. The first update to the Equivalent BMP list will occur on or after March 31, 2016.

## ENDNOTES

<sup>1</sup> See NPDES General Permit No. GAR 10001, Authorization To Discharge Under the National Pollutant Discharge Elimination System Storm Water Discharges Associated with Construction Activity For Stand Alone Construction Projects; NPDES General Permit No. GAR 10002, Authorization To Discharge Under the National Pollutant Discharge Elimination System Storm Water Discharges Associated with Construction Activity for Infrastructure Construction Projects; NPDES General Permit No. GAR 10003, Authorization To Discharge Under the National Pollutant Discharge Elimination System Storm Water Discharges Associated with Construction Activity for Common Developments.

<sup>2</sup> See *Id.* at Permit No. GAR100003 (page 24), Permit No. GAR 100002 (page 21), and Permit No. GAR 10001 (page 21).

<sup>3</sup> GSWCC Guidance Document for Alternative BMPs, *available at* [https://epd.georgia.gov/sites/epd.georgia.gov/files/GSWCC\\_Alternative\\_BMP\\_Guidance\\_Document\\_Oct\\_2008.pdf](https://epd.georgia.gov/sites/epd.georgia.gov/files/GSWCC_Alternative_BMP_Guidance_Document_Oct_2008.pdf).

<sup>4</sup> Ga. Code Ann., § 12-7-3 (10.2) provides:

"Manual for Erosion and Sediment Control in Georgia" or "manual" means the published guidance of the commission governing the design and practices to be utilized in the protection of this state's natural resources from erosion and sedimentation which shall be based foremost upon sound engineering principles and repeatable bench and field testing of structural and vegetative best management practices and which shall have the annual approval of the Erosion and Sediment Control Overview Council established pursuant to Code Section 12-7-7.1.

<sup>5</sup> See Notice of Termination, *available at* <https://gaswcc.georgia.gov/notice-termination-forms>.

<sup>6</sup> State law requires that the design and practices utilized for erosion and sedimentation control must be based on "sound engineering principles and repeatable bench and field testing of structural and vegetative best management practices...." *See supra* note 5.

<sup>7</sup> Ga. Code Ann., § 12-7-19, Education and training certification requirements, provides that:

(a)(1) Persons involved in land development design, review, permitting, construction, monitoring, or inspection or any land-disturbing activity shall meet the education and training certification requirements, dependent on his or her level of involvement with the process, as developed by the commission in accordance with this Code section and in consultation with the division and the Stakeholder Advisory Board created pursuant to Code Section 12-7-20.

(2) On or after May 14, 2007, for each site on which land-disturbing activity occurs, each entity or person acting as either a primary, secondary, or tertiary permittee, as defined in the state general permit, shall have as a minimum one person who is in responsible charge of erosion and sedimentation control activities on behalf of said entity or person and meets the applicable education or training certification requirements developed by the commission present on site whenever land-disturbing activities are conducted on that site.....

<sup>8</sup> The State Soil and Water Conservation Commission is established pursuant to Ga. Code Ann. § 2-6-23, and the Governor appoints one at-large member from each of the five soil and water conservation district regions to serve on the commission.

# APPENDIX B-1

## SOILS INFORMATION AND THE WEB SOIL SURVEY

The Web Soil Survey is an interactive, internet based application that contains soil maps and associated attribute data from soil surveys produced by the National Cooperative Soil Survey. Spatial and attribute data are available on the Web Soil Survey for all Georgia counties that have a completed, correlated soil survey, which includes most, but not all Georgia Counties. A status map of Georgia counties with spatial data available can be found on the Soil Data Mart at <http://soildatamart.nrcs.usda.gov/Statusmap.aspx>.

The URL to access the Web Soil Survey is <http://websoilsurvey.nrcs.usda.gov/>.

The Web Soil Survey Home Page contains guidance on how to use the application, including an explanatory document called “How to Use the Web Soil Survey”.

A brief description of the Web Soil Survey, information it contains, and how to use the application follows. Additional help can be found by clicking on the question mark (?) throughout the application. Other links to downloadable soils data, archived soil survey publications, and a glossary are at the top of the Web Soil Survey screen.

### Start the Web Soil Survey

Start the Web Soil Survey application by clicking on the big green button that says “Start WSS”.

At the top of the page, there are 4 major tabs: Area of Interest (AOI), Soil Map, Soil Data Explorer, and Shopping Cart (Free).

### Locate and Designate the Area of Interest (AOI)

The first step is to locate and outline the AOI. The AOI options will be displayed when the WSS application is started, but can also be accessed at anytime by clicking on the Area of Interest (AOI) tab. There is an Area of Interest Interactive Map on the right side of the screen, and an

AOI can be located by progressively zooming in to the area on the map using the magnifier tool. Alternatively, quick navigation options are on the left side of the screen. These allow for easy selection of locations using several options, including an address, state and county, soil survey area, longitude and latitude, and others.

Click on the navigation method of choice, enter the appropriate selections, and click on *View*. Then use the magnifier tool to zoom in to the specific AOI. One of the two AOI tools is then used to delineate the AOI as a rectangle, or as a multi-sided polygon. Once identified, the AOI will appear as a hatched area within the prescribed boundary. The AOI must be 10,000 acres or smaller in size, unless the entire survey area is selected as an AOI. The AOI can be set to the entire survey area by clicking on *Set AOI*, rather than *View*, when using quick navigation.

### View the Soil Map

Once the AOI is defined, the soil map for the area can be displayed by clicking on the “*Soil Map*” tab. A map with soil lines and soil symbols will be displayed on the right side of the screen. A legend with map symbols, soil map unit names, and the extent of each map unit will be displayed on the left side of the screen. At this point an ADOBE PDF file can be created for download or printing by clicking on the *Printable Version* bar.

Viewing of the map can be switched between a *Full Width Map Layout*, or a “*Normal Map Layout*” with legend, by clicking on the layout icons on the top-right portion of the screen.

Click on the *Legend* tab at the top-left portion of the map to open a legend that allows for customized viewing options. Various features, such as streams, roads, cities, and counties can be turned on or off. The background map can also be switched between aerial photography and topographic maps.

### Explore Soil Data and Interpretations

Access information about the soils by clicking on the Soil Data Explorer tab. This opens up a subset of folders that includes tabs for *Intro to Soils*, *Suitabilities and Limitations for Use*, *Soil*

## *Properties and Qualities, Ecological Site Assessment, and Soil Reports.*

Information on Ecological Site Assessment is not available at this time, but this tab will become active as Ecological Site information is developed in the future.

The *Intro to Soils* folder contains descriptive information about soils and their use. The *Suitabilities and Limitations for Use* folder contains land classifications, productivity ratings, and interpretations for urban and recreational uses, forestland, cropland, waste disposal, water management, and other uses. The *Soil Properties and Qualities* folder contains information about chemical and physical properties of the soils, water features related to the soils, erosion factors, and other soil qualities and features. The *Soil Reports* folder provides for grouping of similar items in soil reports, without the graphical display.

Information in the *Suitabilities and Limitations for Use*, and the *Soil Properties and Qualities* folders, when selected, can be displayed graphically on the map, as the items listed are related to specific soil components.

Click on the *Soil Properties and Qualities* tab, and a list of selectable groups of soil properties and qualities appears.

Click on one of these groups, and specific items appear for selection. For example, selecting *Soil Erosion Factors* will open up selections for K Factor Rock Free, K Factor Whole Soil, T Factor, Wind Erodibility group, and Wind Erodibility Index. Select K Factor Whole Soil, then View Rating to get a map display of the k factors with an associated legend. At this point an ADOBE .pdf file can be created for download or printing by clicking on the Printable Version bar. There is also an option to create a document with multiple selections. Click on the Add to Shopping Cart bar to add any number of items to a customized report, which will be created at the end of the session.

All selected items will have a View Description bar in addition to the View Rating bar. Click on the View Description bar for an explanation

of the feature selected. There will also be a View Description option that can be checked to include a detailed description of the feature as part of the generated report.

### **Check Out**

Click on the *Shopping Cart (Free)* tab to create a customized soil report for any or all of the soil items or reports that were previously selected using the Add to Shopping Cart option. The *Report Properties* option allows for designation of titles, paper sizes and scales. Selections can be made under the *Table of Contents* to remove any reports or descriptive materials not needed. Finally, click on the *Check Out* bar. Choices are to get the report now, or download later. It may be better to download very large files at a later time. An ADOBE PDF file containing customized maps, and selected items about the soils, will be created and made available for download.

Most of the information under the *Suitabilities and Limitations for Use* tab, and the *Soil Properties and Qualities* tab, can also be found under the *Soil Reports* tab. Information from the Soil Reports tab will not be graphically displayed on the map. However, the soil reports offer groupings of several related items, rather than the single item displayed from the other tabs. The reports, along with the associated soil map, may be a good option for many applications.

### **Download data**

There is an option in Web Soil Survey to download the spatial and tabular data for the defined AOI in a format that can be utilized on a local computer in a GIS system, such as Arc-Map. Once the AOI has been identified, click on the *Download Soils Data* option at the top of the screen. Select or deselect tabular data, template database, or spatial data to download, enter an email address, and click the *Download* bar. Processing of the request will commence, and when completed, an email will be sent with a link for downloading the requested data.

### **Content of the Web Soil Survey**

Soil properties, qualities, and interpretations that are currently in the Web Soil Survey under suitabilities, limitations, soil qualities and features, and soil reports are listed below. Content of the Web Soil Survey is refreshed periodically with updates and with additional information.

## Suitabilities and Limitations Ratings in the Web Soil Survey

Category	Interpretation
Building Site Development.....	Corrosion of Concrete
Building Site Development.....	Corrosion of Steel
Building Site Development .....	Dwellings With Basements
Building Site Development.....	Dwellings Without Basements
Building Site Development.....	Lawns, Landscaping, and Golf Fairways
Building Site Development.....	Local Roads and Streets
Building Site Development.....	Shallow Excavations
Building Site Development.....	Small Commercial Buildings
Construction Materials.....	Gravel Source
Construction Materials.....	Roadfill Source
Construction Materials.....	Sand Source
Construction Materials.....	Topsoil Source
Disaster Recovery Planning.....	Catastrophic Mortality, Large Animal Disposal, Pit
Disaster Recovery Planning.....	Catastrophic Mortality, Large Animal Disposal, Trench
Disaster Recovery Planning.....	Clay Liner Material Source
Disaster Recovery Planning.....	Composting Facility - Subsurface
Disaster Recovery Planning.....	Composting Facility - Surface
Disaster Recovery Planning.....	Composting Medium and Final Cover
Disaster Recovery Planning.....	Rubble and Debris Disposal, Large-Scale Event
Land Classifications .....	Farmland Classification (this includes prime farmland and farmland of statewide importance)
Land Classifications .....	Hydric Rating by mapunit
Land Classifications.....	Soil Taxonomy Classification
Land Management.....	Construction Limitations for Haul Roads and Log Landings
Land Management.....	Erosion Hazard (Off-Road, Off- Trail)
Land Management.....	Erosion Hazard (Road, Trail)
Land Management.....	Harvest Equipment Operability
Land Management.....	Mechanical Site Preparation (Deep)
Land Management.....	Mechanical Site Preparation (Surface)
Land Management.....	Potential for Seedling Mortality
Land Management.....	Soil Rutting Hazard
Land Management.....	Suitability for Hand Planting
Land Management.....	Suitability for Log Landings
Land Management.....	Suitability for Mechanical Planting
Land Management.....	Suitability for Roads (Natural Surface)
Military Operations.....	Bivouac Areas
Military Operations.....	Excavations for Crew-Served Weapon Fighting Positions

Military Operations,,,,,,,,,,,,,,,,,,,,,,,,,,,,,Excavations for Individual Fighting Positions  
Military Operations.....Excavations for Vehicle Fighting Positions  
Military Operations.....Helicopter Landing Zones  
Military Operations.....Vehicle Trafficability

Recreational Development .....Camp Areas  
Recreational Development .....Paths and Trails  
Recreational Development .....Picnic Areas  
Recreational Development .....Playgrounds

Sanitary Facilities.....Daily Cover for Landfill  
Sanitary Facilities.....Sanitary Landfill (Area)  
Sanitary Facilities.....Sanitary Landfill (Trench)  
Sanitary Facilities.....Septic Tank Absorption Fields  
Sanitary Facilities.....Sewage lagoons

Vegetative Productivity.....Forest Productivity (Cubic Feet per Acre per Year)  
Vegetative Productivity.....Forest Productivity (Tree Site Index)  
Vegetative Productivity.....Yield of Irrigated Crops (Component)

Vegetative Productivity.....Yield of Non-Irrigated Crops (Component)

Water management.....Embankments, Dikes, and Levees  
Water management.....Excavated Ponds (Aquifer-Fed)

## Soil Properties and Qualities in the Web Soil Survey

Category	Soil Property or Quality
Soil Chemical Properties.....	Calcium Carbonate (CaCO <sub>3</sub> )
Soil Chemical Properties.....	Cation-Exchange Capacity (CEC-7)
Soil Chemical Properties.....	Effective Cation-Exchange Capacity (ECEC)
Soil Chemical Properties.....	Electrical Conductivity (EC)
Soil Chemical Properties.....	Gypsum
Soil Chemical Properties.....	pH (1 to 1 Water)
Soil Chemical Properties.....	Sodium Adsorption Ratio (SAR)
Soil Erosion Factors.....	K Factor, Rock Free
Soil Erosion Factors.....	K Factor, Whole Soil
Soil Erosion Factors.....	T Factor
Soil Erosion Factors.....	Wind Erodibility Group
Soil Erosion Factors.....	Wind Erodibility Index
Soil Physical Properties.....	Available Water Capacity
Soil Physical Properties.....	Available Water Supply, 0 to 100 cm
Soil Physical Properties.....	Available Water Supply, 0 to 150 cm
Soil Physical Properties.....	Available Water Supply, 0 to 25 cm
Soil Physical Properties.....	Available Water Supply, 0 to 50 cm
Soil Physical Properties.....	Bulk Density, 15 Bar
Soil Physical Properties.....	Bulk Density, One-Tenth Bar
Soil Physical Properties.....	Bulk Density, One-Third Bar
Soil Physical Properties.....	Linear Extensibility
Soil Physical Properties.....	Liquid Limit
Soil Physical Properties.....	Organic Matter
Soil Physical Properties.....	Percent Clay
Soil Physical Properties.....	Percent Sand
Soil Physical Properties.....	Percent Silt
Soil Physical Properties.....	Plasticity Index
Soil Physical Properties.....	Saturated Hydraulic Conductivity (K <sub>sat</sub> )
Soil Physical Properties.....	Saturated Hydraulic Conductivity (K <sub>sat</sub> ), Standard Classes
Soil Physical Properties.....	Surface Texture
Soil Physical Properties.....	Water Content, 15 Bar
Soil Physical Properties.....	Water Content, One-Third Bar
Soil Qualities and Features.....	ASHTO Group Classification (Surface)
Soil Qualities and Features.....	Depth to a Selected Soil Restrictive Layer
Soil Qualities and Features.....	Depth to Any Soil Restrictive Layer
Soil Qualities and Features.....	Drainage Class
Soil Qualities and Features.....	Frost Action
Soil Qualities and Features.....	Frost-Free Days
Soil Qualities and Features.....	Hydraulic Soil Group
Soil Qualities and Features.....	Map Unit Name

Soil Qualities and Features.....	Parent Material Name
Soil Qualities and Features.....	Representative Slope
Soil Qualities and Features.....	Unified Soil Classification ( Surface)
Water Features.....	Depth to Water Table
Water Features.....	Flooding Frequency Class
Water Features.....	Ponding Frequency Class

### Reports in the Web Soil Survey

Report	Feature
<b>AOI Inventory</b>	
Component Legend.....	Map unit symbol
Component Legend .....	Map unit name
Component Legend.....	Component percent
Component Legend.....	Component name
Component Legend .....	Component kind
Component Legend.....	Slope percent
Map Unit Description.....	Map Unit Description
Map Unit Description (Brief).....	Map Unit Description (Brief)
Map Unit Description (Brief, Generated)....	Map Unit Description (Brief, Generated)
Selected Soil Interpretations.....	Selected Soil Interpretations
Selected Survey Area	
Interpretation Descriptions.....	Selected Survey Area Interpretation Descriptions
Survey Area Data Summary.....	Survey area version
Survey Area Data Summary.....	Survey area version established date
Survey Area Data Summary.....	Tabular data version
Survey Area Data Summary.....	Tabular data NASIS export data
Survey Area Data Summary.....	Tabular data certification status
<b>Building Site Development</b>	
Dwellings and Small Commercial Buildings.....	Dwellings without basements
Dwellings and Small Commercial Buildings.....	Dwellings with basements
Dwellings and Small Commercial Buildings.....	Small commercial buildings
<b>Construction Materials</b>	
Source of Roadfill and Topsoil.....	Potential as a source of roadfill
Source of Roadfill and Topsoil.....	Potential as a source of topsoil
Source of Sand and Gravel.....	Potential as a source of sand
Source of Sand and Gravel.....	Potential as a source of gravel



## Land Classifications

Hydric Soils.....Hydric Soils  
Land Capability Classification.....Land Capability Classification  
Prime and other Important Farmlands.....Farmland classification  
Taxonomic Classification of the Soils.....Taxonomic Classification of the Soils

## Land Management

Hazard of Erosion and Suitabilities for Roads on Forestland Hazard of off-road or off-trail erosion  
Hazard of Erosion and Suitabilities for Roads on Forestland Hazard of erosion on roads and trails  
Hazard of Erosion and Suitabilities for Roads on Forestland Suitability for roads (natural surface)

## Recreational Development

Camp Areas, Picnic Areas, and Playgrounds.....Camp areas  
Camp Areas, Picnic Areas, and Playgrounds.....Picnic areas  
Camp Areas, Picnic Areas, and Playgrounds.....Playgrounds  
Paths, Trails, and Golf Fairways.....Paths and trails  
Paths, Trails, and Golf Fairways.....Golf fairways

## Sanitary Facilities

Landfills.....Trench sanitary landfill  
Landfills.....Area sanitary landfill  
Landfills.....Daily cover for landfill  
Sewage Disposal.....Septic tank absorption fields  
Sewage Disposal.....Sewage lagoons

## Soil Chemical Properties

Chemical Properties.....Cation exchange capacity  
Chemical Properties.....Effective cation exchange capacity  
Chemical Properties.....Calcium carbonate  
Chemical Properties.....Soil reaction  
Chemical Properties.....Gypsum  
Chemical Properties.....Salinity  
Chemical Properties.....Sodium absorption ratio

## Erosion

RUSLE2 Related Attributes.....hydrologic group  
RUSLE2 Related Attributes.....Kf  
RUSLE2 Related Attributes.....T factor  
RUSLE2 Related Attributes.....Sand percent  
RUSLE2 Related Attributes.....Silt percent  
RUSLE2 Related Attributes.....Clay percent

## Soil Physical Properties

Engineering Properties.....USDA texture  
Engineering Properties.....Unified classification  
Engineering Properties.....AASHTO classification  
Engineering Properties.....Fragments > 10 inches

Engineering Properties.....	Fragments 3-10 inches
Engineering Properties.....	Percent passing sieve number 4
Engineering Properties.....	Percent passing sieve number 10
Engineering Properties.....	Percent passing sieve number 40
Engineering Properties.....	Percent passing sieve number 200
Engineering Properties.....	Liquid limit
Engineering Properties.....	Plasticity index
Particle Size and Coarse Fragments.....	Horizon
Particle Size and Coarse Fragments.....	Depth
Particle Size and Coarse Fragments.....	Sand percent
Particle Size and Coarse Fragments.....	Silt percent
Particle Size and Coarse Fragments.....	Clay percent
Particle Size and Coarse Fragments.....	Total Fragments
Particle Size and Coarse Fragments.....	Fragments 2-74 mm
Particle Size and Coarse Fragments.....	Fragments 75-249 mm
Particle Size and Coarse Fragments.....	Fragments 250-599 mm
Particle Size and Coarse Fragments.....	Fragments >=600 mm

### **Soil Qualities and Features**

Soil Features.....	Restrictive Layer
Soil Features.....	Subsidence
Soil Features.....	Potential for frost action
Soil Features.....	Risk of corrosion-Uncoated steel
Soil Features.....	Risk of corrosion-Concrete

### **Vegetative Productivity**

Forestland Productivity.....	Common trees
Forestland Productivity.....	Site Index
Forestland Productivity.....	Volume of wood fiber
Forestland Productivity.....	Trees to manage
Irrigated Yields by Map Unit Component.....	Land capability
Irrigated Yields by Map Unit Component.....	Crop yields
Nonirrigated Yields by Map Unit Component.....	Land capability
Nonirrigated Yields by Map Unit Component.....	Crop yields

### **Waste Management**

Large Animal Carcass Disposal.....	Large Animal Carcass Disposal, Pit
Large Animal Carcass Disposal.....	Large Animal Carcass Disposal, Trench

### **Water Features**

Water Features.....	Hydrologic group
Water Features.....	Surface runoff
Water Features.....	Water table
Water Features.....	Ponding
Water Features.....	Flooding

## Water Management

Ponds and Embankments.....	Pond reservoir areas
Ponds and Embankments.....	Embankments, dikes, and levees

## Index for the Suitabilities and Limitations Tab in the Web Soil Survey

Interpretation	Category
Bivouac Areas.....	Military Operations
Camp Areas.....	Recreational Development
Catastrophic Mortality, Large Animal Disposal, Pit.....	Disaster Recovery Planning
Catastrophic Mortality, Large Animal Disposal, Trench .....	Disaster Recovery Planning
Clay Liner Material Source.....	Disaster Recovery Planning
Composting Facility - Subsurface.....	Disaster Recovery Planning
Composting Facility - Surface.....	Disaster Recovery Planning
Composting Medium and Final Cover.....	Disaster Recovery Planning
Construction Limitations for Haul Roads and Log Landings..	Land Management
Corrosion of Concrete.....	Building Site Development
Corrosion of Steel.....	Building Site Development
Daily Cover for Landfills.....	Sanitary Facilities
Dwellings With Basements Building.....	Site Development
Dwellings Without Basements.....	Building Site Development
Embankments, Dikes, and Levees.....	Water management
Erosion Hazard (Off-Road, Off- Trail).....	Land Management
Erosion Hazard (Road, Trail).....	Land Management
Excavated Ponds (Aquifer-Fed).....	Water management
Excavations for Crew-Served Weapon Fighting Positions..	Military Operations
Excavations for Individual Fighting Positions.....	Military Operations
Excavations for Vehicle Fighting Positions.....	Military Operations
Farmland Classification (includes prime farmland and farmland of statewide importance).....	Land Classifications
Forest Productivity (Cubic Feet per Acre per Year).....	Vegetative Productivity
Forest Productivity (Tree Site Index).....	Vegetative Productivity
Gravel Source.....	Construction Materials
Harvest Equipment Operability.....	Land Management
Helicopter Landing Zones.....	Military Operations
Hydric Rating by mapunit.....	Land Classifications
Lawns, Landscaping, and Golf Fairways Building.....	Site Development
Local Roads and Streets.....	Building Site Development
Mechanical Site Preparation (Deep).....	Land Management
Mechanical Site Preparation (Surface).....	Land Management
Nonirrigated Capability Class.....	Land Classifications
Nonirrigated Capability Subclass.....	Land Classifications
Paths and Trails.....	Recreational Development

Picnic Areas.....	Recreational Development
Playgrounds.....	Recreational Development
Potential for Seedling Mortality.....	Land Management
Roadfill Source.....	Construction Materials
Rubble and Debris Disposal, Large-Scale Event.....	Disaster Recovery Planning
Sand Source.....	Construction Materials
Sanitary Landfill (Area).....	Sanitary Facilities
Sanitary Landfill (Trench).....	Sanitary Facilities
Septic Tank Absorption Fields.....	Sanitary Facilities
Sewage lagoons.....	Sanitary Facilities
Shallow Excavations.....	Building Site Development
Small Commercial Buildings.....	Building Site Development
Soil Rutting Hazard.....	Land Management
Soil Taxonomy Classification.....	Land Classifications
Suitability for Hand Planting.....	Land Management
Suitability for Log Landings.....	Land Management
Suitability for Mechanical Planting.....	Land Management
Suitability for Roads (Natural Surface).....	Land Management
Topsoil Source.....	Construction Materials
Vehicle Trafficability.....	Military Operations
Yield of Irrigated Crops (Component).....	Vegetative Productivity
Yield of Non-Irrigated Crops (Component).....	Vegetative Productivity

### Index for the Soil Properties and Qualities Tab in the Web Soil Survey

Item	Subcategory
AASHTO Group Classification (Surface).....	Soil Qualities and Features
Available Water Capacity.....	Soil Physical Properties
Available Water Supply, 0 to 100 cm.....	Soil Physical Properties
Available Water Supply, 0 to 150 cm.....	Soil Physical Properties
Available Water Supply, 0 to 25 cm.....	Soil Physical Properties
Available Water Supply, 0 to 50 cm.....	Soil Physical Properties
Bulk Density, 15 Bar.....	Soil Physical Properties
Bulk Density, One-Tenth Bar.....	Soil Physical Properties
Bulk Density, One-Third Bar.....	Soil Physical Properties
Calcium Carbonate (CaCO <sub>3</sub> ).....	Soil Chemical Properties
Cation-Exchange Capacity (CEC-7).....	Soil Chemical Properties
Depth to a Selected Soil Restrictive Layer.....	Soil Qualities and Features
Depth to Any Soil Restrictive Layer.....	Soil Qualities and Features
Depth to Water Table.....	Water Features
Drainage Class.....	Soil Qualities and Features
Effective Cation-Exchange Capacity (ECEC).....	Soil Chemical Properties
Electrical Conductivity (EC).....	Soil Chemical Properties
Flooding Frequency Class.....	Water Features
Frost Action.....	Soil Qualities and Features

Frost-Free Days.....	Soil Qualities and Features
Gypsum.....	Soil Chemical Properties
Hydraulic Soil Group.....	Soil Qualities and Features
K Factor, Rock Free.....	Soil Erosion Factors
K Factor, Whole Soil.....	Soil Erosion Factors
Linear Extensibility.....	Soil Physical Properties
Liquid Limit.....	Soil Physical Properties
Map Unit Name.....	Soil Qualities and Features
Organic Matter.....	Soil Physical Properties
Parent Material Name.....	Soil Qualities and Features
Percent Clay.....	Soil Physical Properties
Percent Sand.....	Soil Physical Properties
Percent Silt.....	Soil Physical Properties
pH (1 to 1 Water).....	Soil Chemical Properties
Plasticity Index.....	Soil Physical Properties
Ponding Frequency Class.....	Water Features
Representative Slope.....	Soil Qualities and Features
Saturated Hydraulic Conductivity (Ksat).....	Soil Physical Properties
Saturated Hydraulic Conductivity (Ksat), Standard Classes.....	Soil Physical Properties
Sodium Adsorption Ratio (SAR).....	Soil Chemical Properties
Surface Texture.....	Soil Physical Properties
T Factor.....	Soil Erosion Factors
Unified Soil Classification ( Surface).....	Soil Qualities and Features
Water Content, 15 Bar.....	Soil Physical Properties
Water Content, One-Third Bar.....	Soil Physical Properties
Wind Erodibility Group.....	Soil Erosion Factors
Wind Erodibility Index.....	Soil Erosion Factors

### Index for the Soil Reports Tab in the Web Soil Survey

Item	Report (Category)
AASHTO classification.....	Engineering Properties (Soil Physical Properties)
Area sanitary landfill.....	Landfills (Sanitary Facilities)
Calcium carbonate.....	Chemical Properties (Soil Chemical Properties)
Camp areas.....	Camp Areas, Picnic Areas, and Playgrounds (Recreational Development)
Cation exchange capacity.....	Chemical Properties (Soil Chemical Properties)
Clay percent.....	RUSLE2 Related Attributes (Erosion)
Clay percent.....	Particle Size and Coarse Fragments (Soil Physical Properties)
Common trees.....	Forestland Productivity (Vegetative Productivity)
Component kind.....	Component Legend (AOI Inventory)
Component name.....	Component Legend (AOI Inventory)
Component percent.....	Component Legend (AOI Inventory)
Crop yields.....	Irrigated Yields by Map Unit Component (Vegetative Productivity)
Crop yields.....	Nonirrigated Yields by Map Unit Component (Vegetative Productivity)
Daily cover for landfill.....	Landfills (Sanitary Facilities)
Depth.....	Particle Size and Coarse Fragments (Soil Physical Properties)

Dwellings with basements.....	Dellings and Small Commercial Buildings (Building Site Development)
Dwellings without basements.....	Dwellings and Small Commercial Buildings (Building Site Development)
Effective cation exchange capacity.....	Chemical Properties (Soil Chemical Properties)
Embankments, dikes, and levees.....	Ponds and Embankments (Water Management)
Farmland classification.....	Prime and other Important Farmlands (Land Classifications)
Flooding.....	Water Features (Water Features)
Fragments > 10 inches.....	Engineering Properties (Soil Physical Properties)
Fragments >=600 mm.....	Particle Size and Coarse Fragments (Soil Physical Properties)
Fragments 250-599 mm.....	Particle Size and Coarse Fragments (Soil Physical Properties)
Fragments 2-74 mm.....	Particle Size and Coarse Fragments (Soil Physical Properties)
Fragments 3-10 inches.....	Engineering Properties (Soil Physical Properties)
Fragments 75-249 mm.....	Particle Size and Coarse Fragments (Soil Physical Properties)
Golf fairways.....	Paths, Trails, and Golf Fairways (Recreational Development)
Gypsum.....	Chemical Properties (Soil Chemical Properties)
Hazard of Erosion on roads and trails.....	Hazard of Erosion and Suitabilities for Roads on Forestland (Land Management)
Hazard of off-road or off-trail Erosion.....	Hazard of Erosion and Suitabilities for Roads on Forestland (Land Management)
Horizon.....	Particle Size and Coarse Fragments (Soil Physical Properties)
Hydric Soils.....	Hydric Soils (Land Classifications)
hydrologic group.....	RUSLE2 Related Attributes (Erosion)
Hydrologic group.....	Water Features (Water Features)
Kf.....	RUSLE2 Related Attributes (Erosion)
Land capability.....	Irrigated Yields by Map Unit Component (Vegetative Productivity)
Land capability.....	Nonirrigated Yields by Map Unit Component (Vegetative Productivity)
Land Capability Classification.....	Land Capability Classification (Land Classifications)
Large Animal Carcass Disposal,Pit.....	Large Animal Carcass Disposal Waste Management
Large Animal Carcass Disposal, Trench.....	Large Animal Carcass Disposal Waste Management
Liquid limit.....	Engineering Properties (Soil Physical Properties)
Map Unit Description.....	Map Unit Description (AOI Inventory)
Map Unit Description (Brief).....	Map Unit Description (Brief) (AOI Inventory)
Map Unit Description(Brief, Generated)....	Map Unit Description (Brief, Generated) (AOI Inventory)
Map unit name.....	Component Legend (AOI Inventory)
Map unit symbol.....	Component Legend (AOI Inventory)
Paths and trails.....	Paths, Trails, and Golf Fairways (Recreational Development)
Percent passing sieve number 10.....	Engineering Properties (Soil Physical Properties)
Percent passing sieve number 200.....	Engineering Properties (Soil Physical Properties)
Percent passing sieve number 4.....	Engineering Properties (Soil Physical Properties)
Percent passing sieve number 40.....	Engineering Properties (Soil Physical Properties)
Picnic areas.....	Camp Areas, Picnic Areas, and Playgrounds (Recreational Development)
Plasticity index.....	Engineering Properties (Soil Physical Properties)
Playgrounds.....	Camp Areas, Picnic Areas, and Playgrounds (Recreational Development)
Pond reservoir areas.....	Ponds and Embankments (Water Management)
Ponding.....	Water Features (Water Features)
Potential as a source of gravel.....	Source of Sand and Gravel Construction Materials

Potential as a source of roadfill.....	Source of Roadfill and Topsoil	Construction Materials
Potential as a source of sand.....	Source of Sand and Gravel	Construction Materials
Potential as a source of topsoil.....	Source of Roadfill and Topsoil	Construction Materials
Potential for frost action.....	Soil Features	Soil Qualities and Features
Restrictive Layer.....	Soil Features	Soil Qualities and Features
Risk of corrosion-Concrete.....	Soil Features	Soil Qualities and Features
Risk of corrosion-Uncoated steel.....	Soil Features	Soil Qualities and Features
Salinity.....	Chemical Properties (Soil Chemical Properties)	
Sand percent.....	RUSLE2 Related Attributes (Erosion)	
Sand percent.....	Particle Size and Coarse Fragments (Soil Physical Properties)	
Selected Soil Interpretations.....	Selected Soil Interpretations (AOI Inventory)	
Selected Survey Area Interpretation Descriptions.....	Selected Survey Area Interpretation Descriptions (AOI Inventory)	
Septic tank absorption fields.....	Sewage Disposal (Sanitary Facilities)	
Sewage lagoons.....	Sewage Disposal (Sanitary Facilities)	
Silt percent.....	RUSLE2 Related Attributes (Erosion)	
Silt percent.....	Particle Size and Coarse Fragments (Soil Physical Properties)	
Site Index.....	Forestland Productivity (Vegetative Productivity)	
Slope percent.....	Component Legend (AOI Inventory)	
Small commercial buildings.....	Dwellings and Small Commercial Buildings (Building Site Development)	
Sodium absorption ratio.....	Chemical Properties (Soil Chemical Properties)	
Soil reaction.....	Chemical Properties (Soil Chemical Properties)	
Subsidence.....	Soil Features	Soil Qualities and Features
Suitability for roads (natural surface).....	Hazard of Erosion and Suitabilities for Roads on Forestland (Land Management)	
Surface runoff.....	Water Features (Water Features)	
Survey area version.....	Survey Area Data Summary (AOI Inventory)	
Survey area version established date.....	Survey Area Data Summary (AOI Inventory)	
T factor.....	RUSLE2 Related Attributes (Erosion)	
Tabular data certification status.....	Survey Area Data Summary (AOI Inventory)	
Tabular data version.....	Survey Area Data Summary (AOI Inventory)	
Tabular data.....	NASIS export data Survey Area Data Summary (AOI Inventory)	
Taxonomic Classification of the Soils.....	Taxonomic Classification of the Soils (Land Classifications)	
Total Fragments.....	Particle Size and Coarse Fragments (Soil Physical Properties)	
Trees to manage.....	Forestland Productivity (Vegetative Productivity)	
Trench sanitary landfill.....	Landfills (Sanitary Facilities)	
Unified classification.....	Engineering Properties (Soil Physical Properties)	
USDA texture.....	Engineering Properties (Soil Physical Properties)	
Volume of wood fiber.....	Forestland Productivity (Vegetative Productivity)	
Water table.....	Water Features (Water Features)	

# APPENDIX B-2

## Estimating Soil Erosion With the Revised Universal Soil Loss Equation (RUSLE2)

Scientific planning for soil erosion reduction requires knowledge of the relations between those factors that cause loss of soil and water and those that help to reduce such losses. The Revised Universal Soil Loss Equation (RUSLE2) is used to estimate the quantity of soil erosion (sheet and rill) caused by water and to design water erosion control systems.

The soil loss predicted by the USLE is that of soil moved off the particular slope segment in sheet and rill erosion. Sheet erosion is defined as the removal of layer of soil from the land surface by the action of rainfall and runoff. It is the first stage in water erosion. This is followed by rill erosion. Rills are small, occur in cropland situations, are removed by normal farming operations, and usually do not reoccur in the same place.

The RUSLE2 does not predict sediment deposition or soil erosion caused by gully, streambank, streambed, mass movement, or wind erosion.

The RUSLE2 equation is:

$$a = r k l s c p$$

**a** is the soil loss in tons per acre per year.

**r** is the rainfall factor. The R factor value quantifies the raindrop impact effect. Rainfall energy is directly related to rain intensity. The energy of a rainstorm is a function of the amount of rain and of all the storm's component intensities. Median raindrop size increases with rain intensity and the terminal velocity of free-falling waterdrops increase with increased dropsizes.

**k** is the soil erodibility factor. Some soils erode more readily than others even when all other factors are the same.

**l,s** is the topographic factor. Both the length, the

steepness and shape of the land slope substantially affect the rate of soil erosion by water.

Slope length is defined as the distance from the point of origin of overland flow of water to the point where either the slope gradient decreases enough that deposition begins, or the runoff water enters a well-defined channel (terrace channel, concentrated flow area, gully, ditch, grass waterway, etc.). It is not the total length or width of the field in most cases.

**c** is the cover and management factor. C is the ratio of soil loss from land with a specified type and amount of cover to the corresponding loss from a clean tilled, continuous fallow site.

**p** is the support practice factor. P is the ratio of soil loss with a specific support practice to the corresponding loss with up-and-down slope farming.

### Soil Loss Tolerance

The term "soil loss tolerance", sometimes called the "T" value, denotes the maximum level of soil erosion that will permit a high level of crop productivity to be sustained economically and indefinitely. Any cropping and management combination for which the predicted erosion rate is less than the tolerance may be expected to provide satisfactory erosion control. Soil loss tolerances range from 1 to 5 tons/acre/year for soils of the U.S. acre/year

### Water Erosion Prediction Project (WEPP)

The development of a new generation of technology for predicting water erosion is under way by a USDA team in the Water Erosion Prediction Project (WEPP). Working with other agencies and academic institutions, the goal of the WEPP is a process oriented model or family of models that are



conceptually superior to the lumped model RUSLE and are more versatile as to the conditions that can be evaluated. The WEPP technology is expected to replace RUSLE sometime in the future.

**Table B-2.1 - Rainfall-Erosion Index Factor “R” Values**

<b>County</b>	<b>R</b>	<b>County</b>	<b>R</b>	<b>County</b>	<b>R</b>
Appling	350	Cherokee	300	Fannin	275
Atkinson	325	Clarke	275	Fayette	300
Bacon	350	Clay	375	Floyd	300
Baker	375	Clayton	300	Forsyth	275
Baldwin	275	Clinch	350	Franklin	300
Banks	300	Cobb	300	Fulton	300
Barrow	275	Coffee	325	Gilmer	275
Bartow	300	Colquitt	350	Glascocock	250
Ben Hill	325	Columbia	250	Glynn	400
Berrien	350	Cook	350	Gordon	300
Bibb	300	Coweta	325	Grady	400
Bleckley	300	Crawford	300	Greene	250
Brantley	375	Crisp	325	Gwinnett	300
Brooks	375	Dade	275	Habersham	300
Bryan	350	Dawson	275	Hall	275
Bulloch	325	Decatur	425	Hancock	250
Burke	275	DeKalb	300	Haralson	325
Butts	300	Dodge	300	Harris	325
Calhoun	375	Dooly	325	Hart	275
Camden	400	Dougherty	350	Heard	325
Candler	300	Douglas	300	Henry	300
Carroll	325	Early	400	Houston	300
Catoosa	275	Echols	350	Irwin	325
Charlton	375	Effingham	350	Jackson	275
Chatham	350	Elbert	250	Jasper	275
Chattahoochee	350	Emanuel	300	Jeff Davis	325
Chattooga	300	Evans	325	Jefferson	275

<b>County</b>	<b>R</b>	<b>County</b>	<b>R</b>	<b>County</b>	<b>R</b>
Jenkins	300	Paulding	300	Toombs	325
Johnson	300	Peach	300	Towns	300
Jones	275	Pickens	275	Treutlen	300
Lamar	300	Pierce	350	Troup	325
Lanier	350	Pike	325	Turner	325
Laurens	300	Polk	300	Twiggs	300
Lee	350	Pulaski	300	Union	300
Liberty	350	Putnam	275	Upton	325
Lincoln	250	Quitman	375	Walker	275
Long	350	Rabun	300	Walton	275
Lowndes	350	Randolph	350	Ware	350
Lumpkin	275	Richmond	250	Warren	250
McDuffie	250	Rockdale	300	Washington	275
McIntosh	400	Schley	325	Wayne	375
Macon	325	Screven	300	Webster	350
Madison	275	Seminole	425	Wheeler	300
Marion	325	Spalding	300	White	300
Meriwether	325	Stephens	300	Whitfield	275
Miller	400	Stewart	350	Wilcox	325
Mitchell	375	Sumter	325	Wilkes	250
Monroe	300	Talbot	325	Wilkinson	275
Montgomery	300	Taliaferro	250	Worth	350
Morgan	275	Tattnall	325		
Murray	275	Taylor	325		
Muscogee	325	Telfair	325		
Newton	300	Terrell	350		
Oconee	275	Thomas	400		
Oglethorpe	250	Tift	350		

# APPENDIX C

## Riprap

### DEFINITION

A revetment of loose rock or similar material installed on a cut or fill slope or a channel side slope to protect the slope from erosion.

### PURPOSE

The purpose of the riprap is to provide a protective, non-erosive cover on a slope.

### CONDITIONS

This standard applies to channels where velocities do not exceed 10 feet per second or to cut or fill slopes where soil conditions, water turbulence and velocity are such that it will not be stable.

### DESIGN CRITERIA

An appropriate geotextile fabric shall be placed between the riprap and soil base. Use NRCS, DOT or the manufacturer's specifications for type and weight of fabric.

The toe of the revetment shall be entrenched in stable channel bottoms for a depth of 1.5 to 3 feet depending on the size of the riprap.

Riprap shall extend up the bank to an elevation where vegetation will provide adequate protection.

For channels, riprap shall be sized as required by channel velocity at full bank flow. Use Table C-1 and Figure C-1. The filter size is also shown in Table C-1.

Riprap shall not be placed on slopes steeper than 1.5 horizontal to 1.0 vertical.

The stone should be reasonably well graded within the gradation curves for each size designated, and any stone gradation, as determined from a field test sample, that lies within these limits shall be acceptable.

The designer should establish the size of graded quarry stone required for the project using acceptable design criteria. Consideration should then be given to using one of the standardized sizes contained in the following tables.

The thickness of the graded quarry stone layer and the gradation are interrelated. The thickness specified normally will vary from 1.0 to 1.5 times the maximum stone size in the gradation. In high turbulence areas, the layer thickness should be 1.5 times the maximum stone size. In low turbulence areas, the layer thickness can be reduced to the dimension of the largest stone in the gradation band.

### CONSTRUCTION SPECIFICATIONS

The channel side slope and the toe excavation shall be prepared to the required lines and grades.

Filter material and riprap shall be placed in succession to the required thicknesses and elevations. Riprap shall be handplaced around structures to prevent damage to the structures.

### Terminology:

**Graded Riprap** - durable, dense, specifically selected and graded, quarried stone, placed to prevent erosion.

**Filter Bedding Stone** - stone generally less than 6 inches in size, that may be placed under graded riprap stone in a layer or combination of layers, designed and installed in such a manner as to prevent loss of underlying soil or finer materials because of moving water.

**Surge Stone** - a quarry run ungraded, un-screened material which may or may not have fines.

The standard sizes of quarried stone for erosion control specifications may be produced by any suitable commercial quarrying method and by the use of any type of sizing device, necessary to produce the desired sizes.

Standard sizes of stone for erosion and sediment control are defined by their weight or square sieve openings. In Georgia two stone classification systems exist: the National Stone Association (N.S.A.) classification and the Department of Transportation (D.O.T.) classification system. Each system separates the stone sizes into two categories: graded

riprap stone sizes and filter bedding stone sizes.

N.S.A. Graded riprap stone sizes are shown in Table C-1.

N.S.A. Filter bedding stone sizes are shown in Table C-1 and C-2.

D.O.T. Graded riprap stone sizes are shown in Table C-3.

D.O.T. Filter bedding stone sizes are shown in Table C-4.

Data for stone center waterways are shown in Table C-5 and Figure C-3.

**Table C-1 Graded Rip-Rap Stone**

Flow Velocity (ft./sec.)	N.S.A. No. <sup>1</sup>	Size Inches (Sq. Opening) Avg. <sup>2</sup>			Filter Stone N.S.A. No. <sup>1</sup>
		Max.		Min.	
2.5	R-1	1 1/2	3/4	No. 8	FS-1
4.5	R-2	3	1 1/2	1	FS-1
6.5	R-3	6	3	2	FS-2
9.0	R-4	12	6	3	FS-2
11.5	R-5	18	9	5	FS-2
13.0	R-6	24	12	7	FS-3
14.5	R-7	30	15	12	FS-3

<sup>1</sup> National Stone Association

<sup>2</sup> At least 50% of the individual stone particles must be equal or larger than this listed size

**Table C-2. Fitter Bedding Stone**

N.S.A. No <sup>1</sup>	Size Inches (Sq. opening)		
	Max.	Avg. <sup>2</sup>	Min. <sup>3</sup>
FS-1	3/8	#30 mesh	#100 mesh
FS-2	2	#4	#100 mesh
FS-3	6 1/2	2 1/2	#16
<sup>1</sup> National Stone Association			
<sup>2</sup> At least 50% of the individual stone particles must be equal or larger than this listed size			
<sup>3</sup> 85 - 100% of the individual stone particles may be less than listed size			

**Table C-3. Graded Rip-Rap Stone**

D.O.T. No. <sup>1</sup>	Size inches (Sq. opening)			Common Uses
	Max.	Avg.	Min.	
Type 3	12	9	5	Creek Banks Pipe Outlets
Type 1	24	12	7	Lakes & Shorelines Rivers
<sup>1</sup> Georgia Department of Transportation				

**Table C-4. Filter Bedding Stone**

D.O.T. No. <sup>1</sup>	Nominal Sizes (inches)
3	2" - 1"
4	1 1/2" - 3/4"
5	1" - 1/2"
6	3/4" - 3/8"
57	1" - No. 4
Georgia Department of Transportation	

**Table C-5. - Gradation of Riprap**

Maximum weight of stone required (lbs.)	Minimum and maximum range in weight of stones (lbs.)	Weight range of 75 percent of stones (lbs.)
150	25 - 150	50 - 150
200	25 - 200	50 - 200
250	25 - 250	50 - 250
400	25 - 400	100 - 400
600	25 - 600	150 - 600
800	25 - 800	200 - 800
1000	50 - 1000	250 - 1000
1300	50 - 1300	325 - 1300
1600	50 - 1600	400 - 1600
2000	75 - 2000	600 - 2000
2700	100 - 2700	800 - 2700

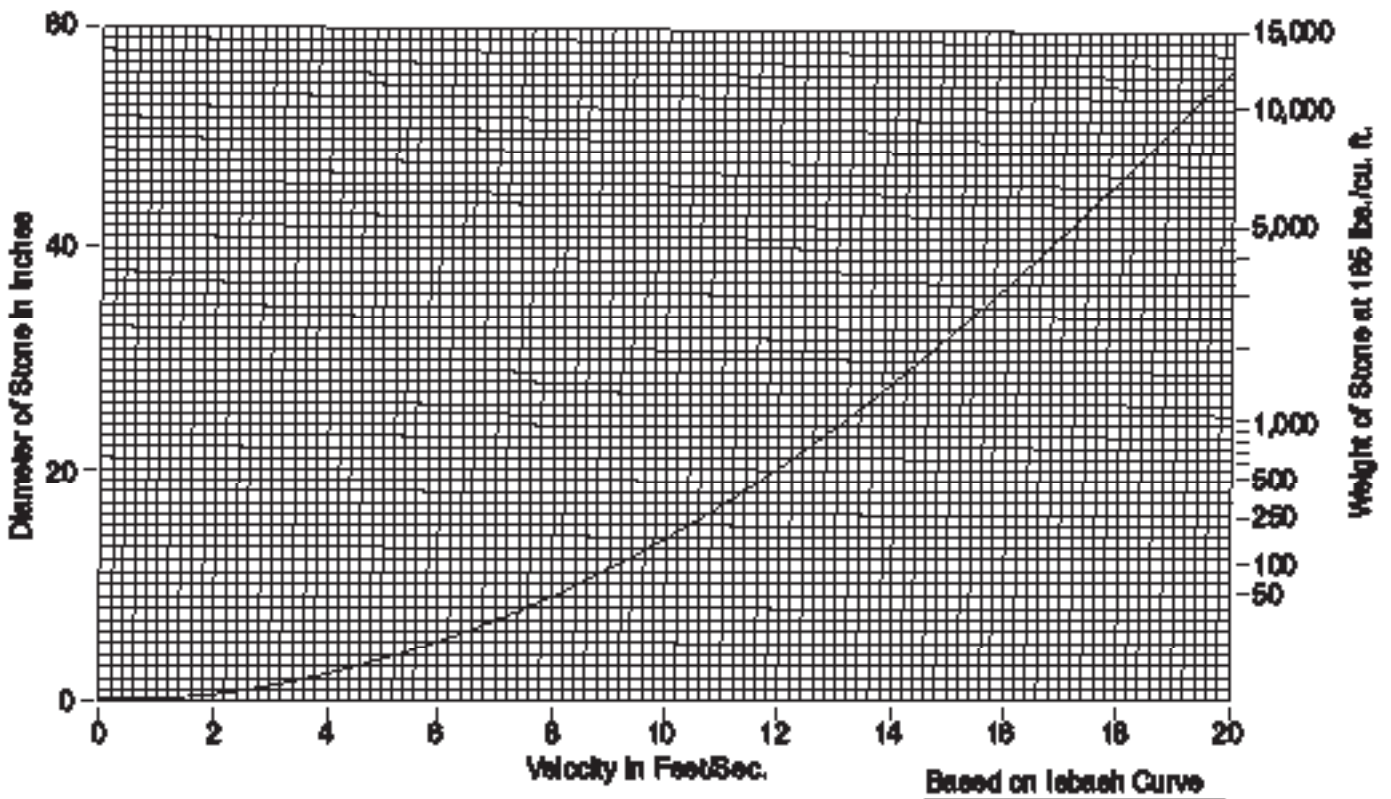

**Figure C-1. - Maximum Stone Size for Riprap**



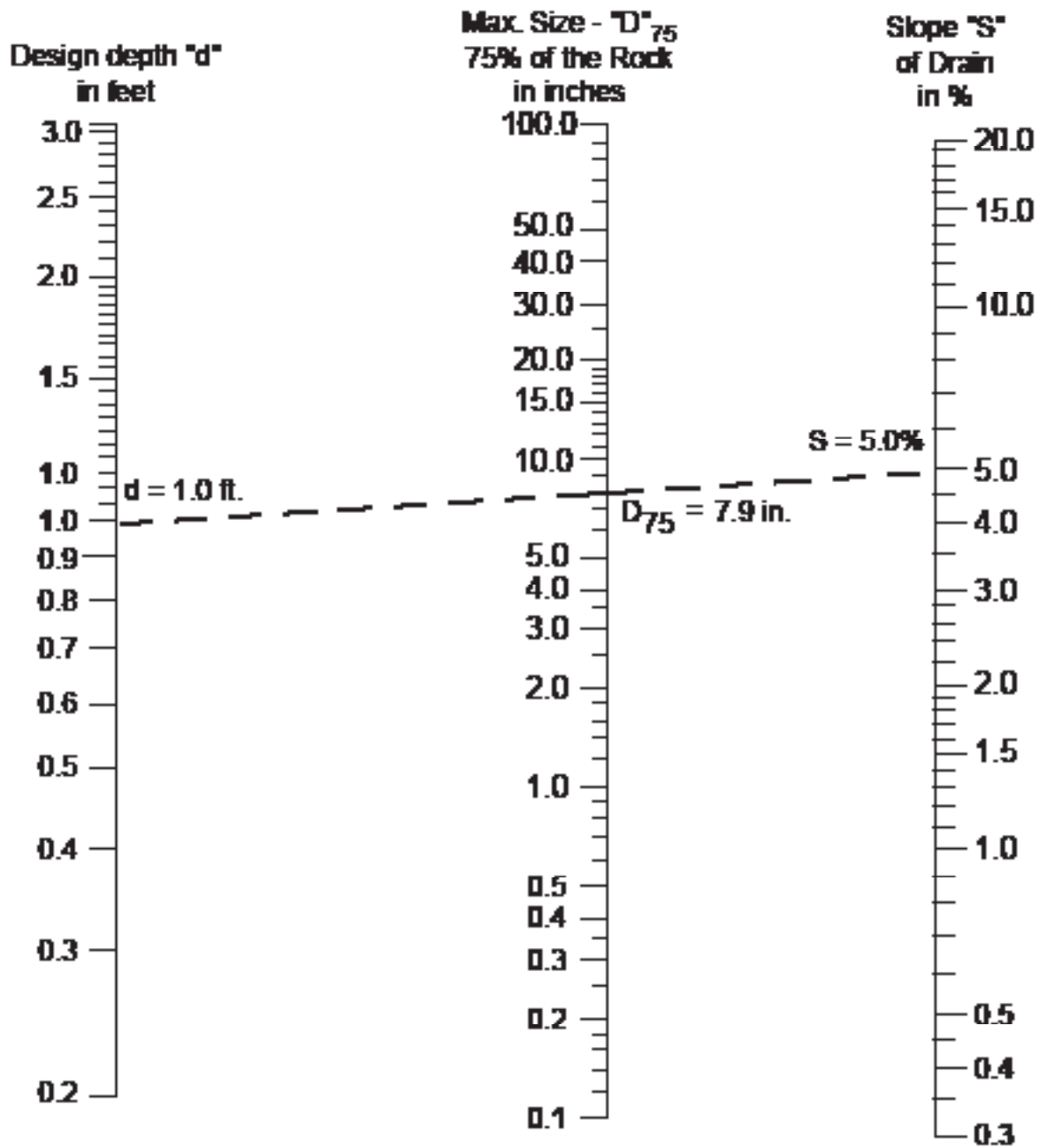

**EXAMPLE:** "d" = 1.0 Feet    "S" = 5%

Place straight edge at "d" value in Design Depth Column and at "S" value in Slope column. Read rock size in middle column 7.9 inches. Say 8 inches.

**FOR DESIGN:**

25% of the rock by volume should be in sizes of 8 inches or slightly larger. The remaining 75% or less should be of well graded material, smaller than 8 inches, including sufficient sands and gravels to fill the voids between the larger rock.

Figure C-2. - Determination of Rock Size for Stone Center Waterway

**Table C-6. - Velocity, Top Width and Depth for Parabolic Stone Center Waterways**

Grade	6 Percent		8 Percent		10 Percent		12 Percent		15 Percent	
V	8.0	10	8.0	10	8.0	10.0	8.0	10.0	8.0	10.0
D	1.3	1.6	1.1	1.3	1.0	1.2	0.9	1.1	0.8	0.9
Q					Top Widths					
20							5		5	
25					5		6		6 4	
30			5		6		7		7 5	
35			6		7		8 5		8 6	
40	6		7		8 5		9 6		10 7	
45	7		8		9 6		10 6		11 7	
50	7		9 6		10 7		11 7		12 8	
55	8		9 6		11 7		12 8		13 9	
60	9		10 7		12 8		13 8		14 9	
65	9		11 7		12 9		14 9		16 11	
70	10	7	12 8		13 9		15 10		17 11	
75	11	7	13 9		14 10		16 10		18 12	
80	12	8	14 9		15 10		18 11		19 13	
90	13	9	15 10		17 12		20 13		21 15	
100	14	10	17 11		19 13		22 14		24 16	
110	16	11	19 13		21 14		24 15		26 18	
120	17	11	21 14		23 16		26 17		29 20	
130	19	12	22 15		25 17		29 18		31 21	
140	20	13	24 16		27 18		31 19		33 23	
150	22	14	26 17		29 20		33 21		36 24	
160	23	15	27 18		31 21		35 22		38 26	
170	25	16	29 19		33 22		37 24		40 28	
180	26	17	31 20		34 23		39 25		43 29	
190	27	18	32 22		36 25		42 26		45 31	
200	29	19	34 23		38 26		44 28		47 33	
220	32	21	38 25		42 29		48 31		52 38	
240	35	23	41 27		46 31		53 33		57 39	
260	38	25	44 30		50 34		57 36		62 42	
280	40	27	48 32		54 36		61 39		67 45	
300	43	29	51 34		57 39		66 42		71 49	

# STONE CENTER WATERWAYS

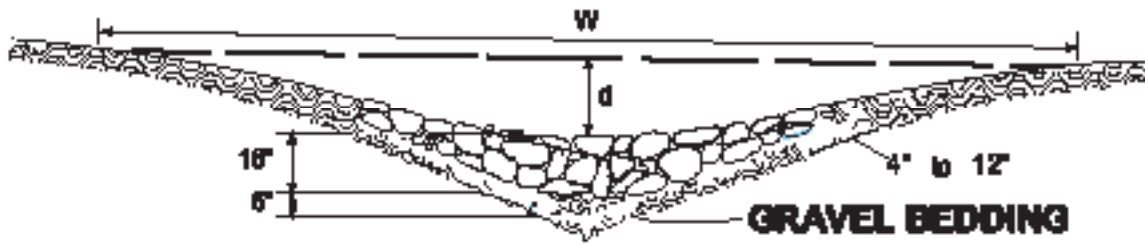

Waterway with stone center drain  
V section shaped by motor petrol

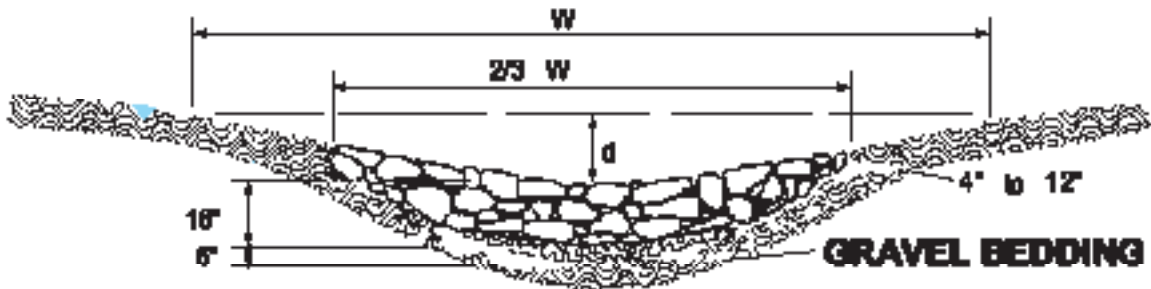

Waterway with stone center drain  
Rounded section shaped by bulldozer

Figure C-3 - Waterway with Stone Center

# **APPENDIX D**

## **Model Soil Erosion and Sedimentation Control Ordinance**

A model ordinance has been developed by the Georgia Soil and Water Conservation Commission and the Georgia EPD for use by officials in municipalities and counties. The model ordinance is intended primarily to provide guidelines for control of urban soil erosion and sediment pollution. It is designed to meet state requirements for establishing programs as required in Act 599, as well as compliance with the NPDES Permits.

An LIA must review, revise, or amend its ordinances within twelve months of any amendment to the E&SC Act.

The Model Ordinance can be found on the GSWCC website at [www.gaswcc.georgia.gov](http://www.gaswcc.georgia.gov), under Documents.

# CONVERSION FACTORS

TO CONVERT:	MULTIPLY BY:	TO OBTAIN:
acres	$1.60 \times 10^2$	sq. rods
acres	$4.047 \times 10^{-1}$	hectares
acres	$4.35 \times 10^4$	sq. ft.
acres	$4.047 \times 10^3$	sq. meters
acres	$1.562 \times 10^{-3}$	sq. miles
acres	$4.840 \times 10^3$	sq. yards
acre-feet	$4.356 \times 10^4$	cu. feet
acre-feet	$3.259 \times 10^5$	gallons
centimeters	$3.937 \times 10^{-1}$	inches
cubic feet	$2.832 \times 10^{-2}$	cu. meters
cubic feet	7.48052	gallons
cubic feet	$2.832 \times 10^1$	liters
cubic feet/min.	$1.247 \times 10^{-1}$	gallons/sec.
cubic feet/sec.	$6.46317 \times 10^{-1}$	million gals/day
cubic meters	$3.531 \times 10^1$	cu. ft.
cubic meters	1.308	cu. yards
cubic meters	$2.642 \times 10^2$	gallons
cubic yards	$2.02 \times 10^2$	gallons
cubic yards	$7.646 \times 10^2$	liters
feet	$3.048 \times 10^1$	centimeters
feet	$3.048 \times 10^{-1}$	meters
feet	$1.894 \times 10^{-4}$	miles
feet of water	$4.335 \times 10^{-1}$	pounds/sq. in.
gallons	$1.337 \times 10^{-1}$	cu. feet
gallons	$3.785 \times 10^{-3}$	cu. meters
gallons	$4.951 \times 10^{-3}$	cu. yards
gallons	3.785	liters
gallons of water	8.337	pounds of water
gallons/min.	$2.228 \times 10^{-3}$	cu. ft/sec.
gallons/min.	$6.308 \times 10^{-2}$	liters/sec.
grams	$2.205 \times 10^{-3}$	pounds
hectares	2.471	acres
hectares	$1.076 \times 10^5$	sq. feet
inches	2.540	centimeters
kilograms	2.2046	pounds
kilograms	$1.102 \times 10^{-3}$	tons
kilometers	$3.281 \times 10^3$	feet
kilometer	$6.214 \times 10^{-1}$	miles
kilometers	$1.0936 \times 10^3$	yards
liters	$2.642 \times 10^{-1}$	gallons
meters	3.281	feet
meters	1.094	yards
miles	$5.280 \times 10^3$	feet
miles	1.609	kilometers
miles	$1.760 \times 10^3$	yards
million gals/day	1.54723	cu. ft/sec.
rods	$1.65 \times 10^1$	feet
square feet	$2.296 \times 10^{-5}$	acres
square feet	$9.29 \times 10^{-2}$	sq. meters
square meters	$1.076 \times 10^1$	sq. ft.
square meters	$3.861 \times 10^{-7}$	sq. miles
square meters	1.196	sq. yards
square miles	$6.40 \times 10^2$	acres
square miles	2.590	sq. kms.
square miles	$3.098 \times 10^6$	sq. yards
square yards	$2.066 \times 10^{-4}$	acres
square yards	9.0	sq. ft.
square yards	$8.361 \times 10^{-1}$	sq. meters
square yards	$3.228 \times 10^{-7}$	sq. miles
tons	$9.0718 \times 10^2$	kilograms
yards	$9.144 \times 10^{-1}$	meters
yards	$5.682 \times 10^{-4}$	miles



# APPENDIX F

## GLOSSARY

The list of terms that follows is representative of those used by soil scientists, engineers, developers, conservationist planners, etc. The terms are not necessarily used in the text, nonetheless they are in common use in conservation matters.

**AASHTO CLASSIFICATION (soil engineering)** - The official classification of soil materials and soil aggregate mixtures for highway construction used by the American Association of State Highway Transportation Officials.

**ACID SOIL** - A soil with a preponderance of hydrogen ions, and probably of aluminum in proportion to hydroxyl ions. Specifically, soil with a pH value less than 7.0. For most practical purposes, a soil with a pH less than 6.6, the values obtained vary greatly with the method used consequently there is no unanimous agreement on what constitutes an acid soil. The term is usually applied to the surface layer or to the root zone unless specified otherwise.

**ACRE-FOOT** - The volume of water that will cover 1 acre to a depth of 1 foot.

**AGGRADATION** - The process of building up a surface by deposition. This is a long-term or geologic trend in sedimentation.

**ALKALINE SOIL** - A soil that has a pH greater than 7.0, particularly above 7.3, throughout most or all of the root zone, although the term is commonly applied to only the surface layer or horizon of a soil.

**ALLUVIAL** - Pertaining to material that is transported and deposited by running water.

**ALLUVIAL LAND** - Areas of unconsolidated alluvium, generally stratified and varying widely in texture, recently deposited by streams, and subject to frequent flooding. A miscellaneous land type.

**ALLUVIAL SOILS** - An axonal great soil group of soils, developed from transported and recently deposited material (alluvium) characterized by a weak modification (or none) of the original material by soil forming processes.

**ALLUVIUM** - A general term for all detrital material deposited or in transit by streams, including gravel, sand, silt, clay, and all variations and mix-

tures of these. Unless otherwise noted, alluvium is unconsolidated.

**ANGLE OF REPOSE** - Angle between the horizontal and the maximum slope that a soil assumes through natural processes.

**ANTECEDENT SOIL WATER** - Degree of wetness of a soil prior to irrigation or at the beginning of a runoff period, expressed as an index or as total inches soil water.

**ANTI-SEEP COLLAR** - A device constructed around a pipe or other conduit and placed through a dam, levee, or dike for the purpose of reducing seepage losses and piping failures.

**ANTI-VORTEX DEVICE** - A facility placed at the entrance to a pipe conduit structure such as a drop inlet spillway or hood inlet spillway to prevent air from entering the structure when the pipe is flowing full.

**APRON (soil engineering)** - A floor or lining to protect a surface from erosion. An example is the pavement below chutes, spillways, or at the toes of dams.

**AUXILIARY SPILLWAY** - A dam spillway built to carry runoff in excess of that carried by the principal spillway. See Emergency Spillway.

**BACKFILL** - The material used to refill a ditch or other excavation, or the process of doing so.

**BEDROCK** - The solid rock underlying soils and the regolith in depths ranging from zero (where exposed by erosion) to several hundred feet.

**BEDLOAD** - The sediment that moves by sliding, rolling, or bounding on or very near the streambed; sediment moved mainly by tractive or gravitational forces or both but at velocities less than the surrounding flow.

**BEST MANAGEMENT PRACTICES (BMP)** - A collection of structural practices and vegetative measures which, when properly designed, installed and maintained, will provide effective erosion and sedimentation control for all rainfall events up to and including a 25-year, 24-hour rainfall event.

**BLINDING MATERIAL** - Material placed on top and around a closed drain to improve the flow of water to the drain and to prevent displacement during back-filling of the trench.

**BLIND INLET** - Inlet to a drain in which entrance of water is by percolation rather than open flow channels.

**BORROW AREA** - A source of earth fill material used in the construction of embankments or other earthfill structures.

**BOTTOM LANDS** - A term often used to define lowlands adjacent to streams.

**BOX-CUT** - The initial cut driven in a property where no open side exists, resulting in a highwall on both sides at the cut.

### **BRUSH MATTING**

- (1) A matting of branches placed on badly eroded land to conserve moisture and reduce erosion while trees or other vegetative covers are being established.
- (2) A matting of mesh wire and brush used to retard streambank erosion.

**CHANNEL** - A natural stream that conveys water; a ditch or channel excavated for the flow of water. See Watercourse.

**CHANNEL IMPROVEMENT** - The improvement of the flow characteristics of a channel by clearing, excavation, realignment, lining, or other means in order to increase its capacity. Sometimes used to connote channel stabilization.

**CHANNEL SLOPE** - Natural or excavated sides (banks) of a watercourse.

**CHANNEL STABILIZATION** - Erosion prevention and stabilization of velocity distribution in a channel using jetties, drops, revetments, vegetation, and other measures.

**CHANNEL STORAGE** - Water temporarily stored in channels while enroute to an outlet.

**COLLOID** - In soil, organic or inorganic matter having very small particle size and a correspondingly large surface area per unit of mass. Most colloidal particles are too small to be seen with the ordinary compound microscope.

**COMPACTION** - In soil engineering, the process

by which the silt grains are rearranged to decrease void space and bring them into closer contact with one another, thereby increasing the weight of solid material per cubic foot.

**CONDUIT** - Any channel intended for the conveyance of water, whether open or closed.

**CONSERVATION** - The protection, improvement, and use of natural resources according to principles that will assure their highest economic or social benefits.

**CONSERVATION DISTRICT** - A public organization created under state enabling law as a special purpose district to develop and carry out a program of soil, water, and related resource conservation, use, and development within its boundaries, usually a subdivision of state government with a local governing body. Often called a soil conservation district or a soil and water conservation district.

### **CONTOUR**

- (1) An imaginary line on the surface of the earth connecting points of the same elevation.
- (2) A line drawn on a map connecting points of the same elevation.

**COVER CROP** - A close-growing crop grown primarily for the purpose of protecting and improving soil between periods of permanent vegetation.

**CRADLE** - A device, usually concrete, used to support a pipe conduit or barrel.

**CREEP (SOIL)** - Slow mass movement of soil and soil material down relatively steep slopes, primarily under the influence of gravity but facilitated by saturation with water and by alternate freezing and thawing.

**CRITICAL AREA** - A severely eroded sediment producing area that requires special management to establish and maintain vegetation to stabilize soil conditions.

**CUT** - A portion of land surface or area from which earth has been removed or will be removed by excavation; the depth below the original ground surface to the excavated surface. Syn. Excavation.

**CUT-AND-FILL** - Process of earth moving by excavating part of an area and using the excavated material for adjacent embankments or fill areas.



**CUTOFF** - A wall, collar or other structure, such as a trench, filled with relatively impervious material intended to reduce seepage of water through porous strata.

**DAM** - A barrier to confine or raise water for storage or diversion, to create a hydraulic head, to prevent gully erosion, or for retention of soil, rock, or other debris.

**DEBRIS** - The loose material arising from the disintegration of rocks and vegetative material; transportable by streams, ice or floods.

**DEBRIS DAM** - A barrier built across a stream channel to retain rock, sand, gravel, silt, or other material.

**DEBRIS GUARD** - A screen or grate at the intake of a channel, drainage, or pump structure for the purpose of stopping debris.

**DEGRADATION** - To wear down by erosion, especially through stream action.

**DESIGN HIGHWATER** - The elevation of the water surface as determined by the flow conditions of the design floods.

**DESIGN LIFE** - The period of time for which a facility is expected to perform its intended function.

**DESILTING AREA** - An area of grass, shrubs, or other vegetation used for inducing deposition of silt and other debris from flowing water; located above a stock tank, pond, field, or other area needing protection from sediment accumulation. See Filter Strip.

**DETENTION DAM** - A dam constructed for the purpose of temporary storage of streamflow or surface runoff and for releasing the stored water at controlled rates.

**DIKE (engineering)** - An embankment to confine or control water, especially one built along the banks of a river to prevent overflow of lowlands; a levee. (geology) A tabular body of igneous rock that cuts across the structure of adjacent rocks or cuts massive rocks.

**DISCHARGE (hydraulics)** - Rate of flow, specifically fluid flow; a volume of fluid passing a point per unit time, commonly expressed as cubic feet per second, million gallons per day, gallons per minute, or cubic meters per second.

**DISCHARGE COEFFICIENT (hydraulics)** - The ratio of actual rate of flow to the theoretical rate of flow through orifices, weirs, or other hydraulic structures.

**DISCHARGE FORMULA (hydraulics)** - A formula to calculate rate of flow of fluid in a conduit or through an opening. For steady flow discharge,  $Q = AV$ , wherein  $Q$  is rate of flow,  $A$  is cross-sectional area and  $V$  is mean velocity. Common units are cubic feet per second, square feet, and feet per second, respectively. To calculate the mean velocity,  $V$  for uniform flow in pipes or open channels see Manning's Formula.

**DISPERSION, SOIL** - The breaking down of soil aggregates into individual particles, resulting in single-grain structure. Ease of dispersion is an important factor influencing the erodibility of soils. Generally speaking, the more easily dispersed the soil, the more erodible it is.

**DIVERSION** - A channel with or without a supporting ridge on the lower side constructed across the top or bottom of a slope for the purpose of intercepting surface runoff.

**DIVERISION DAM** - A barrier built to divert part or all of the water from a stream into a different course.

#### **DRAIN**

- (1) A buried pipe or other conduit (closed drain).
- (2) A ditch (open drain) for carrying off surplus surface water of groundwater.
- (3) To provide channels, such as open ditches or closed drains, so that excess water can be removed by surface flow or by internal flow.
- (4) To lose water (from the soil) by percolation.

#### **DRAINAGE**

- (1) The removal of excess surface water or ground-water from land by means of surface or subsurface drains.
- (2) Soil characteristics that affect natural drainage.

**DRAINAGE, SOIL** - As a natural condition of the soil, soil drainage refers to the frequency and dura-

tion of periods when the soil is free of saturation; for example, in well-drained soils the water is removed readily but not rapidly; in poorly drained soils the root zone is waterlogged for long periods unless artificially drained, and the roots of ordinary crop plants cannot get enough oxygen: in excessively drained soils the water is removed so completely that most crop plants suffer from lack of water. Strictly speaking, excessively drained soils are a result of excessive runoff due to steep slopes or low available water holding capacity due to small amounts of silt and clay in the soil material. The following classes are used to describe soil drainage:

**Well drained** - excess water drains away rapidly and no mottling occurs within 36 inches of the surface.

**Moderately well drained** - water is removed from the soil somewhat slowly, resulting in small but significant periods of wetness. Mottling occurs between 8 and 18 inches.

**Somewhat poorly drained** - water is removed from the soil slowly enough to keep it wet for significant periods but not all of the time. Mottling occurs between 0 to 18 inches.

**Poorly drained** - water is removed so slowly that the soil is wet for a large part of the time. Mottling occurs between 0 to 8 inches.

**Very poorly drained** - water is removed so slowly that the water table remains at or near the surface for the greater part of the time. There may also be periods of surface ponding. The soil has a black to gray surface layer with mottles up to the surface.

**DRAWDOWN** - Lowering of the water surface (in open channel flow), water table, or piezometric surface (in groundwater flow) resulting from a withdrawal of water.

**DROP-INLET SPILLWAY** - An overfall structure in which the water drops through a vertical riser connected to a discharge conduit.

**DROP SPILLWAY** - An overfall structure in which the water drops over a vertical wall onto an apron at a lower elevation.

**DROP STRUCTURE** - A structure for dropping water to a lower level and dissipating its surplus energy; a fall. A drop may be vertical or inclined.

**EARTH DAM** - Dam constructed of compacted

soil material.

**EMBANKMENT** - A man-made deposit of soil, rock, or other material used to form an impoundment.

**EMERGENCY SPILLWAY** - A spillway used to carry runoff exceeding a given design flood. Syn. Auxiliary Spillway.

**ENERGY DISSIPATOR** - A device used to reduce the energy of flowing water.

**ERODIBLE (geology and soils)** - Susceptible to erosion.

## **EROSION**

- (1) The wearing away of the land surface by running water, wind, ice or other geological agents, including such processes as gravitational creep.
- (2) Detachment and movement of soil or rock fragments by water, wind, ice, or gravity. The following terms are used to describe different types of water erosion:

**ACCELERATED EROSION** - Erosion much more rapid than normal, or geologic erosion, primarily as a result of the influence of the activities of man, or in some cases, of other animals or natural catastrophes that expose base surfaces, for example, fires.

**GEOLOGIC EROSION** - The normal or natural erosion caused by geological processes acting over long geologic periods and resulting in the wearing away of mountains, the building up of floodplains, coastal plains, etc. See Natural Erosion.

**GULLY EROSION** - The erosion process whereby water accumulates in narrow channels and, over short periods, removes the soil from this narrow area to considerable depths, ranging from 1 to 2 feet to as much as 75 to 100 feet.

**NATURAL EROSION** - Wearing away of the earth's surface by water, ice, or other natural agents under natural environmental conditions of climate, vegetation, etc., undisturbed by man. See Geological Erosion.

**NORMAL EROSION** - The gradual erosion of land used by man which does not greatly exceed natural erosion. See Natural Erosion.

**RILL EROSION** - An erosion process in which numerous small channels only several inches deep

are formed; occurs mainly on recently disturbed and exposed soils. See Rill.

**SHEET EROSION** - The removal of fairly uniform layer of soil from the land surface by runoff water.

**SPLASH EROSION** - The spattering of small soil particles caused by the impact of raindrops on wet soils. The loosened and spattered particles may or may not be subsequently removed by surface runoff.

**EROSION AND SEDIMENTATION CONTROL PLAN** - A plan for the control of erosion and sediment resulting from a land-disturbing activity.

**EROSION CLASSES (soil survey)** - A grouping of erosion conditions based on the degree of erosion or on characteristic patterns; applied to accelerated erosion, not to normal, natural, or geological erosion. Four erosion classes are recognized for water erosion and three for wind erosion.

**EROSION INDEX** - An interaction term of kinetic energy times maximum 30-minute rainfall intensity that reflects the combined potential of raindrop impact and turbulence of runoff to transport dislodged soil particles from a field.

**EROSIVE** - Having sufficient velocity to cause erosion; refers to wind or water. Not to be confused with erodible as a quality of soil.

**ESCARPMENT** - A steep face or ridge of highland; the scarpnet of a mountain range is generally on that side nearest the sea.

**EXISTING GRADE** - The vertical location of the existing ground surface prior to cutting or filling.

**FERTILIZER** - Any organic or inorganic material of natural or synthetic origin that is added to a soil to supply elements essential to plant growth.

**FERTILIZER ANALYSIS** - The percentage composition of fertilizer, expressed in terms of nitrogen, phosphoric acid, and potash. For example, a fertilizer with a 6-12-6 analysis contains 6 percent nitrogen (N), 12 percent available phosphoric acid (P<sub>2</sub>O<sub>5</sub>) and 6 percent water-soluble potash (K<sub>2</sub>O). Minor elements may also be included. Recent analysis expresses the percentages in terms of the elemental fertilizer (nitrogen, phosphorus, potassium).

**FILLING** - The placement of any soil or other solid material either organic or inorganic on a natu-

ral ground surface or an excavation.

**FILTER STRIP** - A long, narrow vegetative planting used to retard or collect sediment for the protection of diversions, drainage basins or other structures.

**FINAL CUT** - The last cut or line of excavation made when mining a specific property or area.

**FINISHED GRADE** - The final grade or elevation of the ground surface forming proposed design.

**FLOOD** - An overflow or inundation that comes from a river or other body of water and causes or threatens damage.

**FLOOD CONTROL** - Methods or facilities for reducing flood flows.

**FLOOD CONTROL PROJECT** - A structural system installed for protection of land and improvements from floods by the construction of dikes, river embankments, channels, or dams.

**FLOODGATE** - A gate placed in a channel or closed conduit to keep out floodwater or tidal backwater.

**FLOODPEAK** - The highest value of the stage or discharge attained by a flood. The peak stage or peak discharge.

**FLOODPLAIN** - Nearly level land situated on either side of a channel which is subject to overflow flooding.

**FLOODROUTING** - Determining the changes in the rise and fall of floodwater as it proceeds downstream through a valley or reservoir.

**FLOOD STAGE** - The stage at which overflow of the natural banks of a stream begins to cause damage in the reach in which the elevation is measured.

**FLOODWATER RETARDING STRUCTURE** - A structure providing for temporary storage and controlled release of floodwater.

**FLOODWAY** - A channel, either natural, excavated, or bounded by dikes and levees, used to carry excessive flood flows to reduce flooding; sometimes considered to be the transitional area between the active channel and the floodplain.

**FLUME** - A device constructed to convey water on steep grades lined with erosion resistant materials.

**FRAGIPAN** - A natural subsurface horizon with high bulk density relative to the solum above, seemingly cemented when dry but showing a moderate to weak brittleness when moist. The layer is low in organic matter, mottled, slowly or very slowly permeable to water, and usually shows occasional or frequent bleached cracks forming polygons. It may be found in profiles of either cultivated or virgin soils but not in calcareous material.

**FREEBOARD (hydraulics)** - Vertical distance between the maximum water surface elevation anticipated in design and the top of retaining banks or structures provided to prevent overtopping because of unforeseen conditions.

**GAGE OR GAUGE** - Device for registering precipitation, water level, discharge, velocity, pressure, temperature, etc.

**GAGING STATION** - A selected section of a stream channel equipped with a gage, recorder, or other facilities for determining stream discharge.

**GEOTEXTILE** - A term used to describe woven or non-woven fabric materials used to reinforce or separate soil and other materials.

**GRADATION (geology)** - The bringing of a surface or a streambed to grade by running water. As used in connection with sedimentation and fragmental products for engineering evaluation, the term gradation refers to the frequency distribution of the various sized grains that constitute a sediment, soil, or material.

## **GRADE**

- (1) The slope of a road, channel, or natural ground.
- (2) The finished surface of a canal bed, roadbed, top of embankment, or bottom of excavation; any surface prepared for the support of construction like paving or laying a conduit.
- (3) To finish the surface of canal bed, roadbed, top of embankment, or bottom of excavation.

**GRADED STREAM** - A stream in which, over a period of years, the slope is delicately adjusted to provide, with available discharge and with prevailing channel characteristics, just the velocity required for transportation of the load (of sediment) supplied from the drainage basin. The graded pro-

file is a slope of transportation. It is a phenomenon in which the element of time has a restricted connotation. Works of man are limited to his experience and of design and construction.

**GRADE STABILIZATION STRUCTURE** - A structure for the purpose of stabilizing the grade of a gully or other watercourse, thereby preventing further head-cutting or lowering of the channel grade.

**GRADIENT** - Change of elevation, velocity, pressure, or other characteristics per unit length; slope.

**GRADING** - Altering surfaces to specified elevations, dimensions, and/or slopes; this includes stripping, cutting, filling, stockpiling and shaping or any combination thereof and shall include the land in its cut or filled condition.

**GRASS** - A member of the botanical family Gramineae, characterized by bladelike leaves arranged on the culm or stem in two ranks.

**GRASSED WATERWAY** - A natural or constructed waterway, usually broad and shallow, covered with erosion-resistant grasses, used to conduct surface water from cropland.

**GULLY** - A channel or miniature valley cut by concentrated runoff but through which water commonly flows only during and immediately after heavy rains or during the melting of snow. A gully may be dendritic, or branching, or it may be linear; rather long, narrow, and of uniform width. The distinction between gully and rill is one of depth. A gully is sufficiently deep that it would not be obliterated by normal tillage operations, whereas a rill is of lesser depth and would be smoothed by use of ordinary tillage equipment. See Erosion, Rill.

**GULLY EROSION** - See *Erosion*.

**GULLY CONTROL PLANTINGS** - The planting of forage, legume, or woody plant seeds, seedlings, cuttings, or transplants in gullies to establish or re-establish a vegetative cover adequate to control runoff and erosion and incidentally produce useful products.

**HABITAT** - The environment in which the life needs of a plant or animal organism, population or community are supplied.

## **HEAD (hydraulics)**

- (1) The height of water above any plane of

reference.

- (2) The energy, either kinetic or potential, possessed by each unit weight of a liquid, expressed as the vertical height through which a unit weight would have to fall to release the average energy possessed; used in various compound terms such as pressure head, velocity head, and lost head.
- (3) The internal pressure expressed in “feet” or pounds per square inch of an enclosed conduit.

**HEAD GATE** - Water control structure; the gate at the entrance to a conduit.

**HEAD LOSS** - Energy loss due to friction, eddies, changes in velocity, or direction of flow. Syn. *friction-head*.

#### **HEADWATER**

- (1) The source of stream.
- (2) The water upstream from a structure or point on a stream.

**HOOD INLET** - Entrance to a closed conduit that has been shaped to induce full flow at minimum water surface elevation.

**HYDROGRAPH** - A graph showing variation in stage (depth) or discharge of a stream of water over a period of time.

**IMPOUNDMENT** - Generally an artificial collection or storage of water, as a reservoir, pit, dugout, sump, etc. Syn. *reservoir*.

**INFILTRATION** - The gradual downward flow of water from the surface through soil to ground water and water table reservoirs.

**INFILTRATION RATE** - A soil characteristic determining or describing the maximum rate at which water can enter the soil under specified conditions, including the presence of an excess of water.

#### **INLET (hydraulics)**

- (1) A surface connection to a closed drain.
- (2) A structure at the diversion end of a conduit.
- (3) The upstream end of any structure through which water may flow.

**INOCULATION** - The process of introducing pure or mixed cultures or micro-organisms into natural or artificial cultural media.

#### **INTAKE**

- (1) The headworks of a conduit, the place of diversion.
- (2) Entry of water into soil. See *Infiltration*.

**INTAKE RATE** - The rate of entry of water into soil. See *Infiltration Rate*.

**INTENSITY** - Rainfall rate usually in/hr.

**INTERCEPTION (hydraulics)** - The process by which precipitation is caught and held by foliage, twigs, and branches of trees, shrubs, and other vegetation. Often used for “interception loss” or the amount of water evaporated from the precipitation intercepted.

**INTERCEPTION CHANNEL** - A channel excavated at the top of earth cuts, at the foot of slopes or at other critical places to intercept surface flow; a catch drain. Syn. Interception Ditches of water.

#### **INLET (hydraulics)**

- (1) A surface connection to a closed drain.
- (2) A structure at the diversion end of a conduit.
- (3) The upstream end of any structure through which water may flow.

**INOCULATION** - The process of introducing pure or mixed cultures or micro-organisms into natural or artificial cultural media.

#### **INTAKE**

- (1) The headworks of a conduit, the place of diversion.
- (2) Entry of water into soil. See *Infiltration*.

**INTAKE RATE** - The rate of entry of water into soil. See *Infiltration Rate*.

**INTENSITY** - Rainfall rate usually in/hr.

**INTERCEPTION (hydraulics)** - The process by which precipitation is caught and held by foliage, twigs, and branches of trees, shrubs, and other vegetation. Often used for “interception loss” or the amount of water evaporated from the precipitation

intercepted.

**INTERCEPTION CHANNEL** - A channel excavated at the top of earth cuts, at the foot of slopes or at other critical places to intercept surface flow; a catch drain. Syn. *Interception Ditch*.

**INTERCEPTOR DRAIN** - Surface or subsurface drain, or a combination of both, designed and installed to intercept flowing water.

**INTERFLOW** - That portion of rainfall that infiltrates into the soil and moves laterally through the upper soil horizons until intercepted by a stream channel or until it returns to the surface at some point downslope from its point of infiltration.

**INTERMITTENT STREAM** - A stream or portion of a stream that flows only in direct response to precipitation. It receives little or no water from springs and no long-continued supply from melting snow or other sources. It is dry for a large part of the year, ordinarily more than 3 months.

**INTERNAL SOIL DRAINAGE** - The downward movement of water through the soil profile. The rate of movement is determined by the texture, structure, and other characteristics of the soil profile and underlying layers and by the height of the water table, either permanent or perched. Relative terms for expressing internal drainage are: none, very slow, slow, medium, rapid, and very rapid.

**LAND** - The total natural and cultural environment within which production takes place; a broader term than soil. In addition to soil, its attributes include other physical conditions, such as mineral deposits, climate, and water supply; location in relation to centers of commerce, population, and other land; the size of the individual tracts or holdings; and existing plant cover, works of improvement, and the like. Some use the terms loosely in other senses: as defined above but without the economic or cultural criteria; especially in the expression "natural land" as a synonym for "soil"; for the solid surface of the earth; and also for earthy surface formations, especially in the geomorphological expression "land form".

**LAND CAPABILITY** - The suitability of land for use without permanent damage. Land capability, as ordinarily used in the United States, is an expression of the effect of physical land conditions, including climate, on the total suitability for use without damage for crops that require regular till-

age, for grazing, for woodland, and for wildlife. Land capability involves consideration of (1) the risks of land damage from erosion and other causes and (2) the difficulties in land use owing to physical land characteristics, including climate.

**LAND CAPABILITY CLASSIFICATION** - A grouping of kinds of soils into special units, subclasses, and classes according to their capability for intensive use and the treatments required for sustained use. (Prepared by the Natural Resources Conservation Service, USDA.)

**LAND CAPABILITY MAP** - A map showing land capability units, subclasses and classes, or a soil survey map colored to show land capability classes.

**LAND CAPABILITY UNIT** - Capability units provide more specific and detailed information for application to specific fields on a farm or ranch than the subclass of the land capability classification. A capability unit is group of soils that are nearly alike in suitability for plant growth and responses to the same kinds of soil management.

**LAND CLASSIFICATION** - The arrangement of land units into various categories based on the properties of the land or its suitability for some particular purpose.

**LAND-DISTURBING ACTIVITY** - Any land change which may result in soil erosion from water or wind and the movement of sediments into State water or onto lands within the State, including, but not limited to, clearing, dredging, grading, excavating, transporting and filling of land.

**LAND FORM** - A discernible natural landscape, such as a floodplain, stream terrace, plateau, valley, etc.

**LAND RECLAMATION** - Making land capable of more intensive use by changing its general character, as by drainage of excessively wet land; irrigation of arid or semiarid land; or recovery of submerged land from seas, lakes, and rivers. Large-scale reclamation projects usually are carried out through collective effort. Simple improvements, such as cleaning of stumps or stones from land, should not be referred to as land reclamation.

**LEACHING** - The removal from the soil in solution of the more soluble materials by percolating waters.

**LEGUME** - A member of the legume or pulse family, Leguminosae. One of the most important and widely distributed plant families. The fruit is a "legume" or pod that opens along two sutures when ripe. Flowers are usually papilionaceous (butterflylike). Leaves are alternate, have stipules, and are usually compound. Includes many valuable food and forage species, such as the peas, beans, peanuts, clover, alfalfas, sweet clovers, lespedezas, vetches, and kudzu. Practically all legumes are nitrogen-fixing plants.

**LEVEL SPREADER** - A shallow channel excavation at the outlet end of a diversion with a level section for the purpose of diffusing the diversion out-flow.

**LIME** - Lime, from the strictly chemical standpoint, refers to only one compound, calcium oxid (CaO); however, the term "lime" is commonly used in agriculture to include a great variety of materials which are usually composed of the oxide, hydroxide, or carbonate of calcium or of calcium and magnesium. The most commonly used forms of agriculture lime are ground limestone (carbonates), hydrated lime (hydroxides), burnt lime (oxides), marl, and oyster shells.

**LIME, AGRICULTURAL** - A soil amendment consisting principally of calcium carbonate, but including magnesium carbonate and perhaps other materials, used to furnish calcium and magnesium as essential elements for the growth of plants and to neutralize soil acidity.

**LIMING** - The application of lime to land, primarily to reduce soil acidity and supply calcium for plant growth. Dolomitic limestone supplies both calcium and magnesium. It may also improve soil structure, organic matter content, and nitrogen content of the soil by encouraging the growth of legumes and soil microorganisms. Liming an acid soil to pH value of about 6.5 is desirable for maintaining a high degree of availability of most of the nutrient elements required by plants.

**LIQUEFICATION (spontaneous liquefaction)** - The sudden large decrease of the shearing resistance of a cohesionless soil, caused by a collapse of the structure from shock or other type of strain and associated with a sudden but temporary increase in the pore-fluid pressure. It involves a temporary transformation of the material into a fluid mass.

**LIQUID LIMIT (LL)** - The water content corre-

sponding to the arbitrary limit between the liquid and plastic states of consistency of a soil.

**LITTER** - In forestry, a surface layer of loose organic debris in forests, consisting of freshly fallen or slightly decomposed organic materials.

**LOAMY** - Intermediate in texture and properties between fine-textured and coarse-textured materials.

**LOOSE ROCK DAM** - A dam built of rock without the use of mortar, a rubble dam. See Rock-Fill Dam.

**MADE LAND** - Areas filled with earth or earth and trash mixed, usually made by or under the control of man. A miscellaneous land type.

**MANNING'S FORMULA (hydraulics)** - A formula used to predict the velocity of water flow in an open channel or pipelines:

$$V = \frac{1.486r^{2/3} S^{1/2}}{n}$$

wherein V is the mean velocity of flow in feet per second; r is the hydraulic radius; s is the slope of the energy gradient or for assumed uniform flow the slope of the channel in feet per foot; and n is the roughness coefficient or retardance factor of the channel lining.

**MEAN DEPTH (hydraulics)** - Average depth; cross-sectional area of a stream or channel divided by its surface or top width.

**MEAN VELOCITY** - Average velocity obtained by dividing the flow rate discharge by the cross-sectional area for that given cross-section.

**MEASURING WEIR** - A shaped notch through which water flows are measured. Common shapes are rectangular, trapezoidal, and triangular.

**MECHANICAL ANALYSIS** - The analytical procedure by which soil particles are separated to determine the particle size distribution.

**MECHANICAL PRACTICES** - Soil and water conservation practices that primarily change the surface of the land or that store, convey, regulate, or dispose of runoff water without excessive erosion. See Structural Practices.

**MONOLITHIC** - Of or pertaining to a structure formed from a single mass of stone.

**MOUNTAIN TOP REMOVAL** - A mining method in which 100 percent of the overburden covering

a mineral deposit is removed in order to recover 100 percent of the mineral. Excess spoil material is hauled to a nearby hollow to create valley fill.

**MOVEABLE DAM** - A moveable barrier that may be opened in whole or in part, permitting control of the flow of water through or over the dam.

### **MUCK SOIL**

- (1) An organic soil in which the organic matter is well decomposed (USA usage).
- (2) A soil containing 20 to 50 percent organic matter.

**MULCH** - A natural or artificial layer of plant residue or other materials, such as sand or paper, on the soil surface.

**NATURAL GROUND SURFACE** - The ground surface in its original state before any grading, excavation or filling.

**NOISE POLLUTION** - The persistent intrusion of noise into the environment at a level that may be injurious to human health.

**NORMAL DEPTH** - Depth of flow in an open conduit during uniform flow for the given conditions. See *Uniform Flow*.

**OPEN DRAIN** - Natural watercourse or constructed open channel that conveys drainage water.

**OUTFALL** - Point where water flows from a conduit, stream, or drain.

**OUTLET** - Point of water disposal from a stream, river, lake, tidewater, or artificial dam.

**OUTLET CHANNEL** - A waterway constructed or altered primarily to carry water from man-made structures, such as terraces, tile lines, and diversions.

**OVERFALL** - Abrupt change in stream channel elevation; the part of a dam or weir over which the water flows.

**OVERHAUL** - Transportation of excavated material beyond a specified haul limit, usually expressed in cubic yard stations (1 cubic yard hauled 100 feet).

**PARENT MATERIAL (soils)** - The unconsolidated, more or less chemically weathered, mineral or organic matter from which the solum of soils has developed by pedogenic processes. The C horizon may or may not consist of materials similar to those

from which the A and B horizons developed.

**PEAK DISCHARGE** - The maximum instantaneous flow from a given storm condition at a specific location.

**PERCOLATION** - The downward movement of water through soil, especially the downward flow of water in saturated or nearly saturated soil at hydraulic gradients of the order of 1.0 or less.

**PERMEABILITY** - Capacity for transmitting a fluid. It is measured by the rate at which a fluid of standard viscosity can move through material in a given interval of time under a given hydraulic gradient.

**PERMEABILITY, soil** - The quality of soil horizon that enables water or air to move through it. The permeability of a soil may be limited by the presence of one nearly impermeable horizon even though the others are permeable.

**pH** - A numerical measure of the acidity or hydrogen ion activity. The neutral point is pH 7.0. All pH values below 7.0 are acid and all above are alkaline.

**PIPE DROP** - A circular conduit used to convey water down steep grades.

**PLASTICITY INDEX (PI)** - The numerical difference between the liquid limit and the plastic limit.

**PLASTIC LIMIT (PL)** - The water content corresponding to an arbitrary limit between the plastic and semisolid states of consistency of soil.

**PLASTIC SOIL** - A soil capable of being molded or deformed continuously and permanently by relatively moderate pressure.

**PLUNGE POOL** - A device used to dissipate the energy of flowing water that may be constructed or made by the action of flowing. These facilities may be protected by various lining materials.

**POOLS** - Areas of a stream where the velocity provides a favorable habitat for plankton. Silts and other loose materials that settle to the bottom of pools are favorable for burrowing forms of benthos. Syn. riffle.

**PRINCIPAL SPILLWAY** - A water conveying device generally constructed of permanent material and designed to regulate the normal water level, provide flood protection and/or reduce the frequency of operation of the emergency spillway.



**PURE LIVE SEED (PLS)** - A term used to express the quality of seed, even if it is not shown on the label. Expressed as a percentage of the seeds that are pure and will germinate. Determined by multiplying the percent of pure seed times the percents of germination and dividing by 100.

**RATIONAL FORMULA** -  $Q = CIA$ . Where "Q" is the peak discharge measured in cubic feet per second, "C" is the runoff coefficient reflecting the ratio of runoff to rainfall, "I" is the rainfall intensity for the duration of the storm measured in inches per hour, and "A" is the area contributing drainage measured in acres.

**RELIEF DRAIN** - A drain designed to remove water from the soil in order to lower the water table and reduce hydrostatic pressure.

**RELIEF WELL** - Well, pit, or bore penetrating the water table to relieve hydrostatic pressure by allowing flow from the aquifer.

**RESTORATION** - The process of restoring site conditions as they were before the land disturbance.

**RETURN FLOW** - That portion of the water diverted from a stream that finds its way back to the stream channel either as surface or underground flow.

**RILL** - A small intermittent watercourse with steep sides, usually only a few inches deep and thus no obstacle to tillage operations.

**RILL EROSION** - See Erosion.

**RIPRAP** - Broken rock, cobbles, or boulders place on earth surfaces, such as the face of a dam or the bank of a stream for protection against the action of water (waves); also applied to brush or pole mattresses, or brush and stone, or other similar materials used for soil erosion control.

**RISER** - The inlet portions of drop inlet spillway that extend vertically from the pipe conduit barrel to the water surface.

**RIVER BASIN** - A major water resource region. The United States has been divided into 20 river basin areas.

**ROCK-FILL DAM** - A dam composed of loose rock usually dumped in place, often with the upstream part constructed of handplaced or derrick-

placed rock and faced with rolled earth or with an impervious surface of concrete, timber, or steel.

**RUNOFF (hydraulics)** - That portion of the precipitation on a drainage area that is discharged from the area in stream channels. Types include runoff, groundwater runoff, or seepage.

**SCARIFY** - To abrade, scratch, or modify the surface; for example, to scratch the impervious seed coat of hard seed or to break the surface of the soil with a narrow-bladed implement.

**SCREENING** - The use of any vegetative planting, fencing, ornamental wall of masonry, or other architectural treatment, earthen embankment, or a combination of any of these which will effectively hide from view any undesirable areas from the main traveled way.

**SEDIMENT** - Solid material, both mineral and organic, that is in suspension, is being transported, or has been moved from its site of origin by air, water, gravity, or ice, as a product of erosion.

**SEDIMENT BASIN** - A depression formed from the construction of a barrier or dam built at a suitable location to retain sediment and debris.

**SEDIMENT DISCHARGE** - The quantity of sediment, measured in dry weight or by volume, transported through a stream cross-section in a given time. Sediment discharge consists of both suspended load and bedload.

**SEDIMENT LOAD** - See Sediment Discharge.

**SEDIMENT POOL** - The reservoir space allotted to the accumulation of submerged sediment during the life of the structure.

**SEEDBED** - The soil prepared by natural or artificial means to promote the germination of seed and the growth of seedlings.

#### **SEEPAGE**

- (1) Water escaping through or emerging from the ground along an extensive line or surface as contrasted with a spring where the water emerges from a localized spot.
- (2) (percolation) The slow movement of gravitational water through the soil.

**SHEET FLOW** - Water, usually storm runoff, flowing in a thin layer over the ground surface; also

called overland flow.

**SHRINK-SWELL POTENTIAL** - Susceptibility to volume change due to loss or gain in moisture content.

**SHRINKAGE INDEX (SI)** - The numerical difference between the plastic and shrinkage limits.

**SHRINKAGE LIMIT (SL)** - The maximum water content at which a reduction in water content will not cause a decrease in the volume of the soil mass. This defines the arbitrary limit between the solid and semi-solid states.

**SIDE SLOPE** - Generic term used to describe slope of earth-moving operations, generally stated in horizontal to vertical ratio.

### **SILT**

(1) A soil separate consisting of particles between 0.05 and 0.002 millimeter in equivalent diameter.

(2) A soil textural class.

**SILTING** - See *Sediment*.

**SILT LOAM** - A soil textural class containing a large amount of silt and small quantities of sand and clay.

**SILTY CLAY** - A soil textural class containing a relatively large amount of silt and clay and a small amount of sand.

**SILTY CLAY LOAM** - A soil textural class containing a relatively large amount of silt, a lesser quantity of clay, and a still smaller quantity of sand.

**SLOPE** - The degree of deviation of a surface from horizontal, measured in a numerical ratio, percent, or degrees. Expressed as a ratio or percentage, the first number is the vertical distance (rise) and the second is the horizontal distance (run), as 2:1 or 200 percent. Expressed in degrees, it is the angle of the slope from the horizontal plane with a 90° slope being vertical (maximum) and 45° being a 1:1 slope.

**SLOPE CHARACTERISTICS** - Slopes may be characterized as concave (decrease in steepness in lower portion), uniform, or convex (increase in steepness at base). Erosion is strongly affected by shape, ranked in order of increasing erodibility

from concave to uniform to convex.

**SOIL** - The unconsolidated mineral and organic material on the immediate surface of the earth that serves as a natural medium for the growth of land plants.

**SOIL AMENDMENT** - Any material, such as lime, gypsum, sawdust, or synthetic conditioner, that is worked into the soil to make it more amenable to plant growth.

**SOIL HORIZON** - A layer of soil or soil material approximately parallel to the land surface and differing from adjacent genetically related layers in physical, chemical, and biological properties or characteristics, such as color, structure, texture consistence, kinds and numbers of organisms present, degree of alkalinity, etc.

**SOIL PROFILE** - A vertical section of the soil from the surface through all horizons, including C horizons.

**SPILLWAY** - An open or closed channel, or both, used to convey excess water from a reservoir. It may contain gates, either manually or automatically controlled, to regulate the discharge of excess water.

**SPOIL** - Soil or rock material excavated from a canal, ditch, basin, or similar construction.

**STABILIZATION** - The process of establishing an enduring soil cover of vegetation and/or mulch or other ground cover in combination with installing temporary or permanent structures for the purpose of reducing to a minimum the transport of sediment by wind, water, ice or gravity.

**STABILIZED GRADE** - The slope of a channel at which neither erosion nor deposition occurs.

**STAGE (hydraulics)** - The variable water surface or the water surface elevation above any chosen datum. See *Gaging Station*.

**STATE SOIL AND WATER CONSERVATION COMMISSION** - The state agency established by soil and water conservation district enabling legislation to assist with the administration of the provisions of that law.

**STORM DRAIN OUTLET PROTECTION STRUCTURE** - A device used to dissipate the energy of flowing water. Generally constructed of concrete or rock in the form of a partially depressed or partially submerged vessel and may utilize

baffles to dissipate velocities.

**STORM FREQUENCY** - An expression or measure of how often a hydrologic event of a given size or magnitude should on an average occur, based on a reasonable sample.

**STREAMBANKS** - The usual boundaries, not the flood boundaries, of a stream channel. Right and left banks are named facing downstream.

**STREAM GAGING** - The quantitative determination of stream flow using gages, current meters, weirs, or other measuring instruments at selected locations. See *Gaging Station*.

**STREAM LOAD** - Quantity of solid and dissolved material carried by a stream. See *Sediment Load*.

**STRUCTURAL PRACTICES** - Soil and water conservation measures, other than vegetation, utilizing the mechanical properties of matter for the purpose of either changing the surface of the land or storing, regulating, or disposing of runoff to prevent excessive sediment loss. Including but not limited to riprap, sediment basins, dikes, level spreaders, waterways or outlets, diversions, grade stabilization structures, sediment traps, land grading, etc. See *Mechanical Practices*.

**SUBSOIL** - The B horizons of soils with distinct profiles. In soils with weak profile development, the subsoil can be defined as the soil below the plowed soil (or its equivalent of surface soil), in which roots normally grow. Although a common term, it cannot be defined accurately. It has been carried over from early days when "soil" was conceived only as the plowed soil and that under it as the "subsoil".

**SUBWATERSHED** - A watershed subdivision of unspecified size that forms a convenient natural unit.

**TERRACE** - An embankment or combination of an embankment and channel across a slope to control erosion by diverting or storing surface runoff instead of permitting it to flow uninterrupted down from the soil.

**TILE, DRAIN** - Pipe made of burned clay, concrete, or similar material, in short lengths, usually laid with open joints to collect and carry excess water from the soil.

**TILE DRAINAGE** - Land drainage by means of a series of tile lines laid at a specified depth and

grade.

**TILTH** - A soil's physical condition as related to its ease to work (till).

**TOE (engineering)** - Terminal edge or edges of a structure.

**TOE DRAIN** - Interceptor drain located near the downstream toe of a structure.

**TOPSOIL** - Earthy material used as top-dressing for house lots, grounds for large buildings, gardens, road cuts, or similar areas. It has favorable characteristics for production of desired kinds of vegetation or can be made favorable.

**TRASH RACK** - A structural device used to prevent debris from entering a spillway or other hydraulic structure.

**UNIFIED SOIL CLASSIFICATION SYSTEM (engineering)** - A classification system based on the identification of soils according to their particle size, gradation, plasticity index, and liquid limit.

**UNIFORM FLOW** - A state of steady flow when the mean velocity and cross-sectional area are equal at all sections of a reach.

**UNIVERSAL SOIL LOSS EQUATION** - An equation used for the design of water erosion control systems:  $A = RKLSCP$  wherein A = average annual soil loss in tons per acre per year; R = rainfall factor; K = soil erodibility factor; L = length of slope; S = percent of slope; C = cropping and management factor; and P = conservation practice factor.

**VEGETATIVE MEASURES** - Stabilization of erosive or sediment-producing areas by covering the soil with:

- (a) Permanent seeding, producing long-term vegetative cover, or
- (b) Short-term seeding, producing temporary vegetative cover, or
- (c) Sodding, producing areas covered with a turf of perennial sod-forming grass.

**WATER CLASSIFICATION** - separation of water of an area into classes according to usage, such as domestic consumption, fisheries, recreation, industrial, agricultural, navigation, waste disposal, etc.

**WATER CONSERVATION** - The physical control, protection, management, and use of water resources in such a way as to maintain crop, graz-

ing, and forest lands; vegetal cover; wildlife; and wildlife habitat for maximum sustained benefits to people, agriculture, industry, commerce, and other segments of the national economy.

**WATER CONTROL** (soil and water conservation) - The physical control of water by such measures as conservation practices on the land, channel improvement, and installation of structures for water retardation and sediment detention (does not refer to legal control or water rights as defined).

**WATER CUSHION** - Pool of water maintained to absorb the impact of water flowing from an overfall structure.

**WATER DEMAND** - Water requirements for a particular purpose, such as irrigation, power, municipal supply, plant transpiration, or storage.

**WATER DISPOSAL SYSTEM** - The complete system for removing excess water from land with minimum erosion. For sloping land, it may include a terrace system, terrace outlet channels, dams and grassed waterways. For level land, it may include surface drains or both surface and subsurface drains.

**WATER QUALITY STANDARDS** - Minimum requirements of purity of water for various uses; for example, water for agricultural use in irrigation systems should not exceed specific levels of sodium bicarbonates, pH total dissolved salts, etc.

**WATER RESOURCES** - The supply of groundwater and surface water in a given area.

**WATERCOURSE** - Any natural or artificial water-course, stream, river, creek, channel, ditch, canal, conduit, drain, waterway, gully, ravine, or wash in which water flows either continuously or intermittently and which has a definite channel, bed and banks, and including any area adjacent thereto subject to inundation by reason of overflow or floodwater.

**WATERSHED AREA** - All land and water within the confines of a drainage divide or a water problem area consisting in whole or in part of land needing drainage or irrigation.

**WATERSHED LAG** - Time from center of mass of effective rainfall to peak of hydrograph.

**WATERSHED MANAGEMENT** - Use, regulation, and treatment of water and land resources of a watershed to accomplish stated objectives.

**WATERSHED PLANNING** - Formulation of a plan to use and treat water and land resources.

**WATERWAY** - An natural course or constructed channel for the flow of water. See *Grassed Waterway*.

**WEIR** - Device for measuring or regulating the flow of water.

**WEIR NOTCH** - The opening in a weir for the passage of water.

**WETTING AGENT** - A chemical that reduces the surface tension of water and enables it to soak into porous material more readily.

This glossary was compiled from definitions supplied by the Natural Resources Conservation Service, Soil and Water Conservation Society of America, Resource Conservation Glossary, and other state and federal publications.

## REFERENCES

1. Agricultural Research Service and Environmental Protection Agency, *Control of Water Pollution From Cropland*, ARS-H-5-1 or Environmental Protection Agency-600/2-75-026a, November, 1975.
2. Baltimore County, Maryland, *Sediment Control Manual*, October, 1968.
3. Barnett, A.P. and B.H. Hendrickson, "Erosion on Piedmont Soils," *Soil Conservation Magazine*, USDA, Soil Conservation Service, Volume XXVI, No. 2, Sept., 1960.
4. Cooperative Extension Service, Ohio, *Ohio Erosion Control and Sediment Pollution Abatement Guide*, Bulletin 594, March, 1975.
5. Davis, Raymond E., F.S. Foote, and J. W. Delly, *Surveying Theory and Practice*, McGraw-Hill Book Company, 1968.
6. Department of Natural Resources, Georgia, *Land Reclamation Performance Standards*, Draft copy, October 1975.
7. Department of Natural Resources, West Virginia, *Drainage Handbook for Surface Mining*, January, 1975.
8. Department of Public Works, Division of Highways, California, *Bank and Shore Protection in California Highway Practice*, November, 1970.
9. Department of Transportation, Georgia, *Standard Specifications: Construction of Roads and Bridges*, 1993.
10. Diseker, E. G., and Richardson, E.C., *Transaction of the American Society of Agricultural Engineers*, St. Joseph, Michigan, vol. 1, No. 1, pp 62-64, 68.
11. Environmental Protection Agency, *Guidelines for Erosion and Sediment Control Planning and Implementation*, Environmental Protection Agency-R2-72-015, August 1972.
12. Environmental Protection Agency, *Control of Erosion and Sediment Deposition From Construction of Highways and Land Development*, September, 1971.
13. Environmental Protection Agency, *Methods and Practices for Controlling Water Pollution From Agricultural Non-Point Sources*, Environmental Protection Agency-430/9-73-015, October, 1973.
14. Environmental Protection Agency, *Proceedings Workshop on Agricultural Non-Point Source Water Pollution Control*, September 16-17, 1974, Mayflower Hotel, Washington, D.C.
15. Environmental Protection Agency, *Guidelines for Erosion and Sediment Control Planning and Implementation*, Environmental Protection Agency-430/9-73-014, October, 1973.
16. Environmental Protection Agency, *Processes, Procedures, and Methods to Control Pollution Resulting from All Construction Activity*, Environmental Protection Agency-430/9-73-007, October, 1973.
17. Federal Highway Administration, *Suggestions for Temporary Erosion and Siltation Control Measures*, February, 1973.
18. Georgia Soil and Water Conservation Commission, *Georgia Governor's Conference on Sediment Control*, Center for Continuing Education, Athens, Georgia, July 22-24, 1973.

19. Georgia Soil and Water Conservation Commission, *Guidelines for Streambank Restoration*, September, 1994.
20. Inman, Ernest J., *Flow Characteristics of Georgia's Streams*, United States Department of the Interior, Geological Survey, open file report, Atlanta, Georgia, 1971.
21. Kostielney, Janet L., "Erosion Control and Crop Farming," *Erosion Control*, April, 1999.
22. Meyer, L.D., "Overview of the Urban Erosion and Sedimentation Process," *Proceedings of National Symposium on Urban Rainfall and Runoff and Sediment Control*, July 29-31, 1974.
23. Michigan Department of Natural Resources, *Michigan Soil Erosion and Sedimentation Control Guidebook*, February, 1975.
24. National Association of Counties Research Foundation, *Community Action Guidebook for Soil Erosion and Sediment Control*, March 1970.
25. National Association of Counties Research Foundation, *Urban Soil Erosion and Sediment Control*, Program #15030DTL, May 1970.
26. New Jersey State Soil Conservation Committee, *Standards for Soil Erosion and Sediment Control in New Jersey*.
27. Pennsylvania Department of Environmental Resources, *Soil Erosion and Sedimentation Control Manual for Agriculture*, 1998.
28. Soil and Water Conservation Society of America, *Soil Erosion: Prediction and Control*, 1977.
29. Soil Conservation Service, *Engineering Field Manual*, September 1969.
30. Soil Conservation Service, *Georgia, Manual of Standards and Specifications for Control of Soil Erosion and Sediment in Areas Undergoing Urban Development*, July 1972.
31. Soil Conservation Service, *Guide to Sedimentation Investigation*, Technical Guide No. 12, September, 1975.
32. Soil Conservation Service, *Guidelines for the Control of Erosion and Sediment in Urban Areas of the Northeast*, August, 1970.
33. Soil Conservation Service, *Michigan Program for Soil Erosion and Sedimentation Control*, July 1973.
34. Soil Conservation Service, *Mississippi, Guidelines for the Control of Erosion and Sediment in Urbanizing Areas Within Mississippi*, August, 1975.
35. Soil Conservation Service, *National Engineering Handbook, Section 3, Sedimentation, Section 4, Hydrology*.
36. Soil Conservation Service, *North Carolina, Guide for Sediment Control on Construction Sites in North Carolina*, March, 1973.
37. Soil Conservation Service, Ohio, *Water Management and Sediment Control for Urbanizing Areas*, April, 1972.
38. Soil Conservation Service, *Planning and Design of Open Channels*, Technical Release No. 25, December,

1964.

39. Soil Conservation Service, *Procedure for Computing Sheet and Rill Erosion on Project Areas*, Technical Release No. 51, Geology, January 1975.

40. Soil Conservation Service, *Standards and Specification for Soil Erosion and Sediment Control in Urbanizing Areas*, November, 1968.

41. Soil Conservation Service, *Urban Hydrology for Small Watersheds*, 2nd Edition, Technical Release No. 55, June, 1986.

42. United States Forestry Service, *Tractor Attachments for Brush, Slash and Root Removal*, ED & T 1332, January, 1971.

43. United States Geological Survey Water - Data Report Georgia-75-1, *Water Resources Data for Georgia Water Year 1975*, Georgia-75-1.

44. USDA Agricultural Research Service, *PAMphlet: a concise guide for safe and practical use of polyacrylamide(PAM) for irrigation-induced erosion control and infiltration enhancement*. USDA-ARS Northwest Irrigation and Soils Research Laboratory Station Note #02-98.

45. USDA Agricultural Research Service, *Predicting Rainfall Erosion Losses - A Guide to Conservation Planning*, Agriculture Handbook Number 537, 1978.

46. USDA Agricultural Research Service, *Predicting Soil Erosion by Water - A guide to Conservation Planning with the Revised Universal Soil Loss Equation (RUSLE)*, Agriculture Handbook Number 703, Draft, 1993.

47. USDA Natural Resources Conservation Service, *Erosion Prediction*, Field Office Technical Guide, May, 1993.

48. USDA Natural Resources Conservation Service, *Conservation Practice Standard, Critical Area Planting (Acre)*, CODE 342, Georgia, April 1999.

49. University of Georgia, Institute of Ecology, Office of Public Service & Outreach, *A Review of the Scientific Literature on Riparian Buffer Width, Extent and Vegetation*, Seth Wenger, March, 1999.

50. Virginia Soil and Water Conservation Commission, *Virginia Erosion and Sediment Control Handbook*, 3rd Edition, 1992.

51. Wischmeier, W.H., C.B. Johnson and B.V. Cross, *A Soil Erodibility Nomograph for Farmland and Construction Sites*. *Journal of Soil and Water Conservation* 26(5): 189-193, 1971.

